

ITEM	PART NO.	DESCRIPTION	Q'TY	REV	DATE	DESCRIPTION	APPROVAL	REF.
1	RETAINER	PLASTIC UL94V-0		0	09-JUN-09	ORIGINAL RELEASE	<i>NJK</i>	
2	FILTER	POLYURETHANE FOAM UL94HF-1 30PPI		A	09-JUN-09	CHG PART NUMBER	<i>NJK</i>	
3	GUARD	PLASTIC UL94V-0						

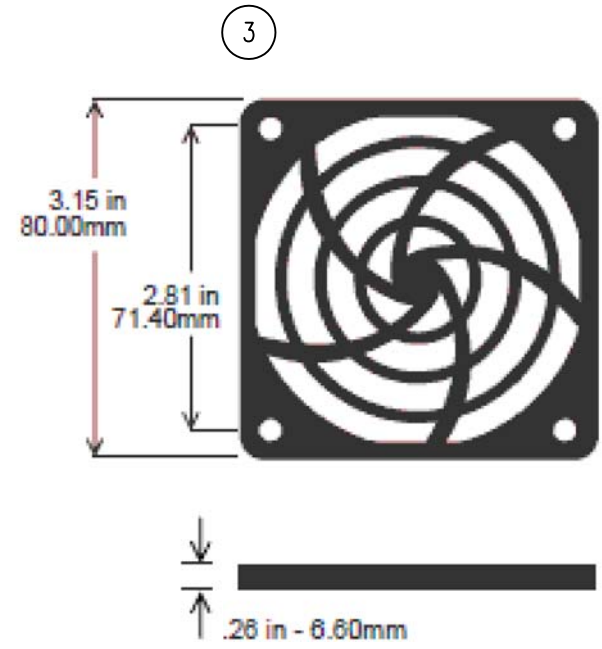
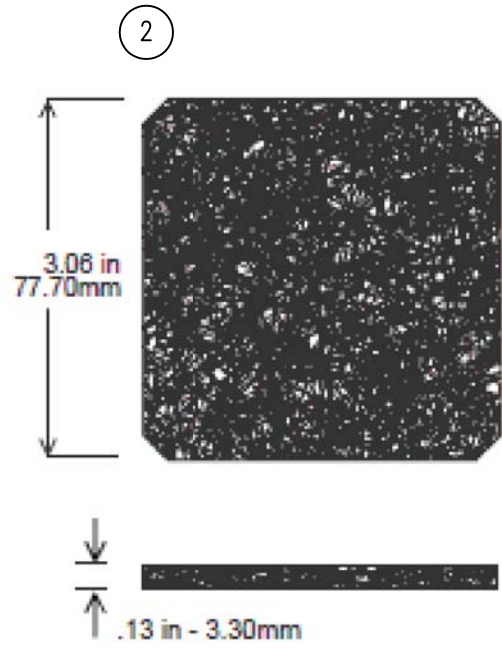
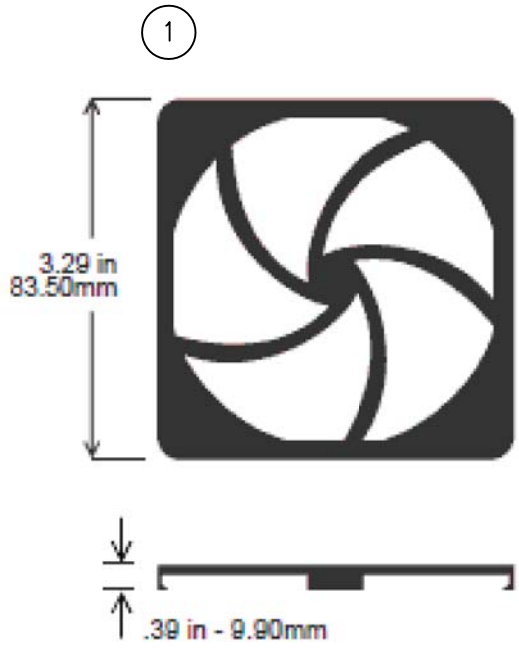

<small>UNLESS NOTED: TOLERANCES SHALL BE X = ±.300 .XX = ±.150 .XXX = ±.075 ANGULAR = ±.2°</small> <small>THIS DRAWING IS THE PROPERTY OF SANYO DENKI AMERICA, INC. AND SHALL BE DEEMED AS PROPRIETARY INFORMATION. USE OF ANY INFORMATION CONTAINED HEREIN SHALL BE PROHIBITED WITHOUT WRITTEN PERMISSION OF SANYO DENKI AMERICA, INC.</small>	REMARKS			SHOWN Q'TY	OPPOSITE Q'TY
	THIRD ANGLE	SCALE	MATERIAL	APPROVED BY: <i>NJK</i>	DRAWN BY: <i>BEV</i>
	METRIC			DATE: 09-JUN-09	DATE: 09-JUN-09
	MODEL			NAME FAN GUARD	
SANYO DENKI AMERICA, INC. <small>TORRANCE, CALIFORNIA, U.S.A.</small>			DRAWING NO. FK80-30	REVISED A	