

LUF 10.00/04/90V 5.0SN BK BX

Weidmüller Interface GmbH & Co. KG
 Klingenbergstraße 26
 D-32758 Detmold
 Germany

www.weidmueller.com

Product image

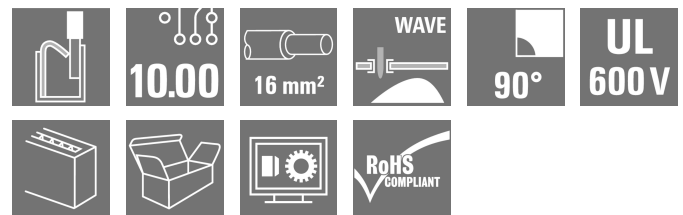

High-performance PCB terminal with a PUSH IN connection system for conductor cross-sections up to 16 mm².

- Fast connection without tools thanks to pushers to open the contact point, or direct plug-in method
- Securely closed contact point, with the "Connection Safety Concept" the conductor is always clamped securely
- Integrated test point for PS 2.0 test plug
- Central tip test point for test probes on the upper side of the terminal
- Increased derating reserves because WEMID insulating material is used.
- Conductor outlet direction of 180°

General ordering data

| | |
|--------------|--|
| Version | Printed circuit board terminals, 10.00 mm, Number of poles: 4, 90°, Solder pin length (l): 5 mm, tinned, black, PUSH IN with lever, Clamping range, max.: 25 mm ² , Box |
| Order No. | 2453710000 |
| Type | LUF 10.00/04/90V 5.0SN BK BX |
| GTIN (EAN) | 4050118483734 |
| Qty. | 30 items |
| Product data | IEC: 1000 V / 92 A / 0.5 - 25 mm ² UL: 600 V / 58 A / AWG 18 - AWG 6 |
| Packaging | Box |

LUF 10.00/04/90V 5.0SN BK BX

Weidmüller Interface GmbH & Co. KG
Klingenbergstraße 26
D-32758 Detmold
Germany

www.weidmueller.com

Technical data

Approvals

Approvals



ROHS Conform
UL File Number Search [UL Website](#)
Certificate No. (cURus) E60693

Dimensions and weights

| | | | |
|--------------------------|------------|-----------------|-------------|
| Depth | 26.45 mm | Depth (inches) | 1.0413 inch |
| Height | 47.03 mm | Height (inches) | 1.8516 inch |
| Height of lowest version | 42.03 mm | Width | 41.58 mm |
| Width (inches) | 1.637 inch | Net weight | 36.93 g |

Environmental Product Compliance

RoHS Compliance Status Compliant without exemption
REACH SVHC No SVHC above 0.1 wt%

System parameters

| | | | |
|--|---|--|------------------------------|
| Product family | OMNIMATE Power - series LU | Wire connection method | PUSH IN with lever |
| Mounting onto the PCB | THT solder connection | Conductor outlet direction | 90° |
| Pitch in mm (P) | 10.00 mm | Pitch in inches (P) | 0.394 " |
| Number of poles | 4 | Pin series quantity | 1 |
| Fitted by customer | No | Number of rows | 1 |
| Solder pin length (l) | 5 mm | Solder pin dimensions | d = 1.2 mm, Octagonal |
| Solder eyelet hole diameter (D) | 1.6 mm | Solder eyelet hole diameter tolerance (D)+ | 0,1 mm |
| Number of solder pins per pole | 2 | Screwdriver blade | 0.8 x 4.0 |
| Stripping length | 18 mm | L1 in mm | 30.00 mm |
| L1 in inches | 1.181 " | Touch-safe protection acc. to DIN VDE 0470 | IP20 plugged/ IP10 unplugged |
| Touch-safe protection acc. to DIN VDE 57 106 | touch-safe with connected connectors from 6 mm ² | Protection degree | IP20 |

Material data

| | | | |
|----------------------------------|------------|-----------------------------|--------|
| Insulating material | Wemid (PA) | Colour | black |
| Colour chart (similar) | RAL 9011 | Insulating material group | I |
| Comparative Tracking Index (CTI) | ≥ 600 | Moisture Level (MSL) | |
| UL 94 flammability rating | V-0 | Contact base material | E-Cu |
| Contact material | Cu-alloy | Contact surface | tinned |
| Storage temperature, min. | -40 °C | Storage temperature, max. | 70 °C |
| Operating temperature, min. | -40 °C | Operating temperature, max. | 120 °C |

Conductors suitable for connection

| | |
|---|---------------------|
| Clamping range, min. | 0.5 mm ² |
| Clamping range, max. | 25 mm ² |
| Wire connection cross section AWG, min. | AWG 20 |
| Wire connection cross section AWG, max. | AWG 4 |
| Solid, min. H05(07) V-U | 0.5 mm ² |
| Solid, max. H05(07) V-U | 16 mm ² |

Creation date 06.11.2025 08:32:57 MEZ

Catalogue status / Drawings

LUF 10.00/04/90V 5.0SN BK BX

Weidmüller Interface GmbH & Co. KG

Klingenbergstraße 26
D-32758 Detmold
Germany

www.weidmueller.com

Technical data

| | | | | |
|---|--|------------------------------|-----------------------------|-------|
| Stranded, min. H07V-R | 6 mm ² | | | |
| Stranded, max. H07V-R | 25 mm ² | | | |
| Flexible, min. H05(07) V-K | 0.5 mm ² | | | |
| Flexible, max. H05(07) V-K | 25 mm ² | | | |
| w. plastic collar ferrule, DIN 46228 pt 4, 0.5 mm ² min. | | | | |
| w. plastic collar ferrule, DIN 46228 pt 4, 16 mm ² max. | | | | |
| w. wire end ferrule, DIN 46228 pt 1, 0.5 mm ² min. | | | | |
| w. wire end ferrule, DIN 46228 pt 1, 16 mm ² max. | | | | |
| Plug gauge in accordance with EN 60999 a x b; ø | 5.3mm (B6) | | | |
| Clampable conductor | Cross-section for conductor connection | Type | fine-wired | |
| | | nominal | 2.5 mm ² | |
| | wire end ferrule | Stripping length | nominal | 20 mm |
| | | Recommended wire-end ferrule | H2,5/25D BL | |
| | | Stripping length | nominal | 18 mm |
| | | Recommended wire-end ferrule | H2,5/18 | |
| | Cross-section for conductor connection | Type | fine-wired | |
| | | nominal | 4 mm ² | |
| | wire end ferrule | Stripping length | nominal | 20 mm |
| | | Recommended wire-end ferrule | H4,0/26D GR | |
| | | Stripping length | nominal | 18 mm |
| | | Recommended wire-end ferrule | H4,0/18 | |
| | Cross-section for conductor connection | Type | fine-wired | |
| | | nominal | 6 mm ² | |
| | wire end ferrule | Stripping length | nominal | 20 mm |
| | | Recommended wire-end ferrule | H6,0/26 SW | |
| | | Stripping length | nominal | 18 mm |
| | | Recommended wire-end ferrule | H6,0/18 | |
| | Cross-section for conductor connection | Type | fine-wired | |
| | | nominal | 10 mm ² | |
| | wire end ferrule | Stripping length | nominal | 21 mm |
| | | Recommended wire-end ferrule | H10,0/28 EB | |
| | | Stripping length | nominal | 18 mm |
| | | Recommended wire-end ferrule | H10,0/18 | |
| Cross-section for conductor connection | Type | fine-wired | | |
| | nominal | 16 mm ² | | |
| wire end ferrule | Stripping length | nominal | 21 mm | |
| | Recommended wire-end ferrule | H16,0/28 GN | | |
| | Stripping length | nominal | 18 mm | |
| | Recommended wire-end ferrule | H16,0/18 | | |
| Cross-section for conductor connection | Type | fine-wired | | |
| | nominal | 1.5 mm ² | | |
| wire end ferrule | Stripping length | nominal | 20 mm | |
| | Recommended wire-end ferrule | H1,5/24 R | | |
| | Stripping length | nominal | 18 mm | |

LUF 10.00/04/90V 5.0SN BK BX

Weidmüller Interface GmbH & Co. KG
 Klingenbergstraße 26
 D-32758 Detmold
 Germany

www.weidmueller.com

Technical data

Recommended wire-end ferrule [H1.5/18](#)

Reference text Length of ferrules is to be chosen depending on the product and the rated voltage., The outside diameter of the plastic collar should not be larger than the pitch (P)

Rated data acc. to IEC

| | | | |
|---|---------------|---|--------|
| tested acc. to standard | IEC 60947-7-4 | Rated current, min. number of poles (Tu=20°C) | 92 A |
| Rated current, max. number of poles (Tu=20°C) | 80 A | Rated current, min. number of poles (Tu=40°C) | 82 A |
| Rated current, max. number of poles (Tu=40°C) | 76 A | Rated voltage for surge voltage class / pollution degree II/2 | 1000 V |
| Rated voltage for surge voltage class / pollution degree III/2 | 690 V | Rated voltage for surge voltage class / pollution degree III/3 | 1000 V |
| Rated impulse voltage for surge voltage class/ pollution degree II/2 | 6 kV | Rated impulse voltage for surge voltage class/ pollution degree III/2 | 6 kV |
| Rated impulse voltage for surge voltage class/ contamination degree III/3 | 8 kV | | |

Rated data acc. to CSA

| | | | |
|-----------------------------------|--------|-----------------------------------|-------|
| Rated voltage (Use group B / CSA) | 600 V | Rated voltage (Use group C / CSA) | 600 V |
| Rated voltage (Use group D / CSA) | 600 V | Rated current (Use group B / CSA) | 58 A |
| Rated current (Use group C / CSA) | 58 A | Rated current (Use group D / CSA) | 5 A |
| Wire cross-section, AWG, min. | AWG 18 | Wire cross-section, AWG, max. | AWG 6 |

Rated data acc. to UL 1059

| | | | |
|---------------------------------------|--|---------------------------------------|--------|
| Institute (cURus) | CURUS | Certificate No. (cURus) | E60693 |
| Rated voltage (Use group B / UL 1059) | 600 V | Rated voltage (Use group C / UL 1059) | 600 V |
| Rated voltage (Use group D / UL 1059) | 600 V | Rated current (Use group B / UL 1059) | 58 A |
| Rated current (Use group C / UL 1059) | 58 A | Rated current (Use group D / UL 1059) | 5 A |
| Wire cross-section, AWG, min. | AWG 18 | Wire cross-section, AWG, max. | AWG 6 |
| Reference to approval values | Specifications are maximum values, details - see approval certificate. | | |

Packing

| | | | |
|-----------|-----------|------------|-----------|
| Packaging | Box | VPE length | 276.00 mm |
| VPE width | 170.00 mm | VPE height | 47.00 mm |

Type tests

| | | | |
|-------------------------------|----------------|--|------------------------------|
| Test: Durability of markings | Standard | IEC 60947-1 section 8.2.4.5.1 / 06.07, IEC 60512-1-1:2002-02 | |
| | Test | mark of origin, type identification, pitch, durability, stripping length | |
| | Evaluation | available | |
| Test: Clampable cross section | Standard | IEC 60999-1 section 7 and 9.1 / 11.99, IEC 60947-1 section 8.2.4.5.1 / 03.11 | |
| | Conductor type | Type of conductor and conductor cross-section | solid 0.5 mm ² |
| | | Type of conductor and conductor cross-section | stranded 0.5 mm ² |
| | | Type of conductor and conductor cross-section | solid 16 mm ² |

LUF 10.00/04/90V 5.0SN BK BX

Weidmüller Interface GmbH & Co. KG
 Klingenbergstraße 26
 D-32758 Detmold
 Germany

www.weidmueller.com

Technical data

| | | | | |
|---|---|---|-----------------------------|--|
| | | Type of conductor and conductor cross-section | stranded 16 mm ² | |
| | | Type of conductor and conductor cross-section | H07V-U16 | |
| | | Type of conductor and conductor cross-section | H07V-U6 | |
| | | Type of conductor and conductor cross-section | H07V-K16 | |
| | | Type of conductor and conductor cross-section | AWG 4 | |
| | Evaluation | passed | | |
| Test for damage to and accidental loosening of conductors | Standard | IEC 60999-1 section 9.4 / 11.99 | | |
| | Requirement | 0.3 kg | | |
| | Conductor type | Type of conductor and conductor cross-section | AWG 20/1 | |
| | | Type of conductor and conductor cross-section | AWG 20/19 | |
| | | Type of conductor and conductor cross-section | H05V-U0.5 | |
| | | Type of conductor and conductor cross-section | H05V-K0.5 | |
| | Evaluation | passed | | |
| | Requirement | 2.9 kg | | |
| | Conductor type | Type of conductor and conductor cross-section | H07V-U16 | |
| | | Type of conductor and conductor cross-section | H07V-K16 | |
| Evaluation | passed | | | |
| Requirement | 4,5 kg | | | |
| Conductor type | Type of conductor and conductor cross-section | AWG 4/7 | | |
| | Type of conductor and conductor cross-section | AWG 4/19 | | |
| Evaluation | passed | | | |
| Pull-out test | Standard | IEC 60999-1 section 9.5 / 11.99 | | |
| | Requirement | ≥20 N | | |
| | Conductor type | Type of conductor and conductor cross-section | AWG 20/1 | |
| | | Type of conductor and conductor cross-section | AWG 20/19 | |
| | | Type of conductor and conductor cross-section | H05V-U0.5 | |
| | | Type of conductor and conductor cross-section | H05V-K0.5 | |
| | Evaluation | passed | | |
| | Requirement | ≥100 N | | |

LUF 10.00/04/90V 5.0SN BK BX

Weidmüller Interface GmbH & Co. KG
 Klingenbergstraße 26
 D-32758 Detmold
 Germany

www.weidmueller.com

Technical data

| | | |
|----------------|---|----------|
| Conductor type | Type of conductor and conductor cross-section | H07V-U16 |
| | Type of conductor and conductor cross-section | H07V-K16 |
| Evaluation | passed | |
| Requirement | ≥ 135 N | |
| Conductor type | Type of conductor and conductor cross-section | AWG 4/7 |
| | Type of conductor and conductor cross-section | AWG 4/19 |
| Evaluation | passed | |

Important note

IPC conformity Conformity: The products are developed, manufactured and delivered according international recognized standards and norms and comply with the assured properties in the data sheet resp. fulfill decorative properties in accordance with IPC-A-610 "Class 2". Further claims on the products can be evaluated on request.

- Notes**
- Additional variants on request
 - Rated current related to rated cross-section & min. No. of poles.
 - Wire end ferrule without plastic collar to DIN 46228/1
 - Wire end ferrule with plastic collar to DIN 46228/4
 - P on drawing = pitch
 - Rated data refer only to the component itself. Clearance and creepage distances to other components are to be designed in accordance with the relevant application standards.
 - The test point can only be used as potential-pickup point.
 - The single-position PCB terminal block can be used for voltages up to 1500 V (DC) and 1000 V (AC). The relevant device standard and the appropriate required clearances and creepage distances should be observed in the application
 - Long term storage of the product with average temperature of 50 °C and maximum humidity 70%, 36 months

Classifications

| | | | |
|-------------|-------------|-------------|-------------|
| ETIM 6.0 | EC002643 | ETIM 7.0 | EC002643 |
| ETIM 8.0 | EC002643 | ETIM 9.0 | EC002643 |
| ETIM 10.0 | EC002643 | ECLASS 9.0 | 27-44-04-01 |
| ECLASS 9.1 | 27-44-04-01 | ECLASS 10.0 | 27-44-04-01 |
| ECLASS 11.0 | 27-46-01-01 | ECLASS 12.0 | 27-46-01-01 |
| ECLASS 13.0 | 27-46-01-01 | ECLASS 14.0 | 27-46-01-01 |
| ECLASS 15.0 | 27-46-01-01 | | |

LUF 10.00/04/90V 5.0SN BK BX

Weidmüller Interface GmbH & Co. KG
 Klingenbergstraße 26
 D-32758 Detmold
 Germany

www.weidmueller.com

Drawings

Product image

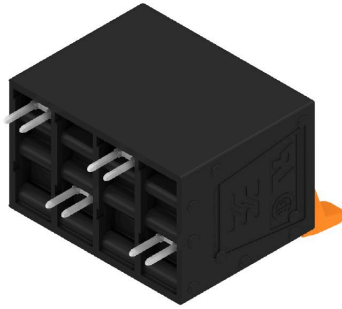

Dimensional drawing

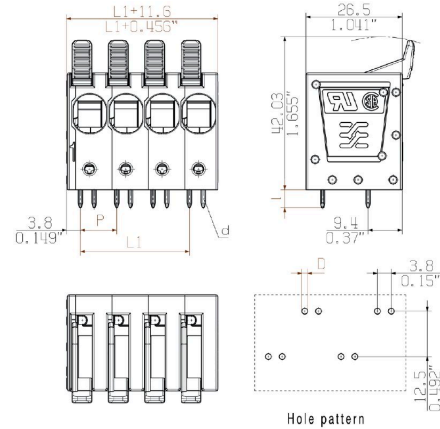

Derating curve

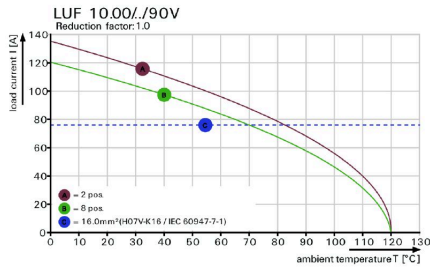

Derating curve

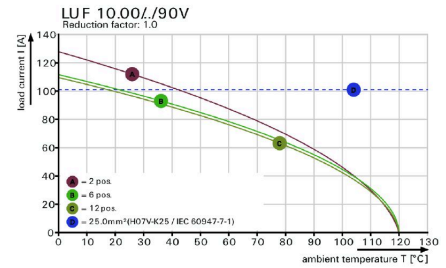

Product benefits

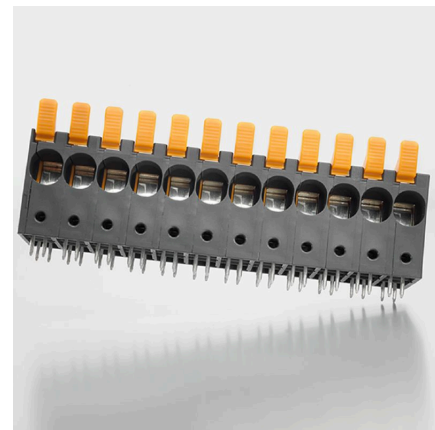

High stability through pin design

Product benefits

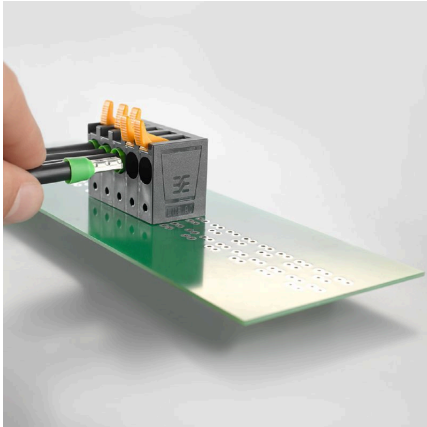

PUSH IN connection up to 16 mm²