

WDU 35 SW

Weidmüller Interface GmbH & Co. KG

Klingenbergstraße 26

D-32758 Detmold

Germany

www.weidmueller.com

Product image

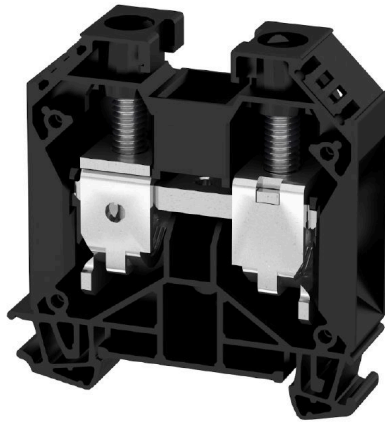

To feed through power, signal, and data is the classical requirement in electrical engineering and panel building. The insulating material, the connection system and the design of the terminal blocks are the differentiating features. A feed-through terminal block is suitable for joining and/or connecting one or more conductors. They could have one or more connection levels that are on the same potential or insulated against one another.

General ordering data

Version	Feed-through terminal block, Screw connection, black, 35 mm ² , 125 A, 1000 V, Number of connections: 2
Order No.	1020510000
Type	WDU 35 SW
GTIN (EAN)	4032248534326
Qty.	40 items

Technical data

Approvals

Approvals



ROHS	Conform
UL File Number Search	UL Website
Certificate No. (UR)	E60693
Certificate No. (cURusEX)	E184763

Dimensions and weights

Depth	62.5 mm	Depth (inches)	2.4606 inch
Depth including DIN rail	63 mm	Height	60 mm
Height (inches)	2.3622 inch	Width	16 mm
Width (inches)	0.6299 inch	Net weight	51.78 g

Temperatures

Storage temperature	-25 °C...55 °C	Ambient temperature	-5 °C...40 °C
Continuous operating temp., min.	-60 °C	Continuous operating temp., max.	130 °C

Environmental Product Compliance

RoHS Compliance Status	Compliant without exemption		
REACH SVHC	No SVHC above 0.1 wt%		
Product Carbon Footprint	Cradle to gate	0.437 kg CO2eq.	

Material data

Basic material	Wemid	Colour	black
UL 94 flammability rating	V-0		

Rating data IECEX/ATEX

Certificate No. (ATEX)	DEMKO14ATEX1338U	Certificate No. (IECEX)	IECEXULD14.0005U
Max. voltage (ATEX)	690 V	Current (ATEX)	115 A
Wire cross section max. (ATEX)	35 mm ²	Max. voltage (IECEX)	690 V
Current (IECEX)	115 A	Wire cross section max. (IECEX)	35 mm ²
Marking EN 60079-7	Ex eb II C Gb	Ex 2014/34/EU label	II 2 G D

System specifications

Version	Screw connection, for screwable cross-connection, One end without connector	End cover plate required	Yes
Number of potentials	1	Number of levels	1

WDU 35 SW

Weidmüller Interface GmbH & Co. KG

Klingenbergstraße 26
D-32758 Detmold
Germany

www.weidmueller.com

Technical data

Number of clamping points per level	2	Number of potentials per tier	1
Levels cross-connected internally	No	PE connection	No
Mounting rail	TS 35	N-function	No
PE function	No	PEN function	Yes

2 clampable conductors (H05V/H07V) with equal cross-section (rated connection)

Wire connection cross section, finely stranded with wire-end ferrules DIN 46228/1, 2 clampable wires, max.	16 mm ²	Wire connection cross section, finely stranded with wire-end ferrules DIN 46228/1, 2 clampable wires, min.	2.5 mm ²
Wire cross-section, finely stranded, two clampable wires, max.	16 mm ²	Wire connection cross section, finely stranded, two clampable wires, min.	2.5 mm ²
Cross-section for connected wire, stranded, two clampable wires, max.	16 mm ²	Cross-section for connected wire, stranded, two clampable wires, min.	16 mm ²

Additional technical data

Open sides	right	Number of similar terminals	1
Explosion-tested version	Yes	Type of mounting	Snap-on

CSA rating data

Voltage size C (CSA)	600 V	Current size C (CSA)	150 A
Certificate No. (CSA)	200039-1057876	Wire cross section min. (CSA)	12 AWG

Conductors for clamping (additional connection)

Connection type, additional connection Screw connection

Conductors for clamping (rated connection)

Gauge to IEC 60947-1	B8, B9	Wire connection cross section AWG, max.	AWG 2
Connection direction	on side	Tightening torque, max.	5 Nm
Tightening torque, min.	4 Nm	Stripping length	18 mm
Type of connection	Screw connection	Number of connections	2
Clamping range, max.	50 mm ²	Clamping range, min.	2.5 mm ²
Clamping screw	M 6	Blade size	6.5 x 1.2 mm
Wire connection cross section AWG, min.	AWG 12	Wire connection cross-section, finely stranded with wire-end ferrules DIN 46228/4, max.	35 mm ²
Wire connection cross-section, finely stranded with wire-end ferrules DIN 46228/4, min.	2.5 mm ²	Wire connection cross-section, finely stranded with wire-end ferrules DIN 46228/1, max.	35 mm ²
Wire connection cross-section, finely stranded with wire-end ferrules DIN 46228/1, min.	2.5 mm ²	Wire connection cross section, finely stranded, max.	35 mm ²
Wire connection cross section, finely stranded, min.	2.5 mm ²	Connection cross-section, stranded, max.	50 mm ²
Connection cross-section, stranded, min.	2.5 mm ²	Twin wire-end ferrules, max.	16 mm ²
Twin wire-end ferrules, min.	1.5 mm ²	Wire connection cross-section, solid core, max.	16 mm ²
Wire connection cross-section, solid core, min.	2.5 mm ²	Connection cross-section, finely stranded, min.	2.5 mm ²

General

Wire connection cross section AWG, max.	AWG 2	Wire connection cross section AWG, min.	AWG 12
Standards	IEC 60947-7-1	Mounting rail	TS 35

WDU 35 SW

Weidmüller Interface GmbH & Co. KG

Klingenbergstraße 26
D-32758 Detmold
Germany

www.weidmueller.com

Technical data

Rating data

Rated cross-section	35 mm ²	Rated voltage	1000 V
Rated DC voltage	1000 V	Nominal current	125 A
Current at maximum wires	150 A	Standards	IEC 60947-7-1
Volume resistance according to IEC 60947-7-x	0.26 mΩ	Rated impulse withstand voltage	8 kV
Power loss in accordance with IEC 60947-7-x	4.00 W	Surge voltage category	III
Pollution severity	3		

UL rating data

Conductor size Factory wiring max. (UR)	0 AWG	Current size C (UR)	150 A
Voltage size C (UR)	1000 V	Conductor size Factory wiring min. (UR)	12 AWG
Certificate No. (UR)	E60693	Conductor size Field wiring min. (UR)	12 AWG
Conductor size Field wiring max. (UR)	0 AWG		

Classifications

ETIM 6.0	EC000897	ETIM 7.0	EC000897
ETIM 8.0	EC000897	ETIM 9.0	EC000897
ETIM 10.0	EC000897	ECLASS 9.0	27-14-11-20
ECLASS 9.1	27-14-11-20	ECLASS 10.0	27-14-11-20
ECLASS 11.0	27-14-11-20	ECLASS 12.0	27-14-11-20
ECLASS 13.0	27-25-01-01	ECLASS 14.0	27-25-01-01
ECLASS 15.0	27-25-01-01		

Drawings

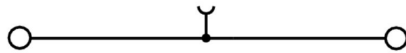

WDU 35 SW

Weidmüller Interface GmbH & Co. KG
 Klingenbergstraße 26
 D-32758 Detmold
 Germany

www.weidmueller.com

Accessories

35 mm²



Power feed-in

Our wide range of W-Series terminal blocks with our WPD main line branch terminals, which are optimised to guarantee both convenience and space gains, ensures a secure and convenient connection at the power feed-in.

General ordering data

Type	WQV 35/2	Version
Order No.	1053060000	Cross-connector (terminal), when screwed in, yellow, 138 A, Number
GTIN (EAN)	4008190097349	of poles: 2, Pitch in mm (P): 16.00, Insulated: Yes, Width: 9.85 mm
Qty.	50 ST	
Type	WQV 35/3	Version
Order No.	1055360000	Cross-connector (terminal), when screwed in, yellow, 112 A, Number
GTIN (EAN)	4008190007249	of poles: 3, Pitch in mm (P): 16.00, Insulated: Yes, Width: 9.85 mm
Qty.	50 ST	
Type	WQV 35/4	Version
Order No.	1055460000	Cross-connector (terminal), when screwed in, yellow, 112 A, Number
GTIN (EAN)	4008190130275	of poles: 4, Pitch in mm (P): 16.00, Insulated: Yes, Width: 9.85 mm
Qty.	50 ST	
Type	WQV 35/10	Version
Order No.	1053160000	Cross-connector (terminal), when screwed in, yellow, 112 A, Number
GTIN (EAN)	4008190026028	of poles: 10, Pitch in mm (P): 16.00, Insulated: Yes, Width: 9.85 mm
Qty.	10 ST	

2.5-10 mm²

2.5-10
mm²

End plates are fitted to the open side of the last modular terminal before the end bracket. The use of an end plate ensures the function of the modular terminal and the specified rated voltage. It guarantees protection against contact with live parts and makes the final terminal finger-proof.

General ordering data

Type	WAP 16+35 WTW 2.5-10	Version
Order No.	1050100000	End and partition plate for terminals, dark beige, Height: 56 mm,
GTIN (EAN)	4008190079901	Width: 1.5 mm, V-0, Wemid
Qty.	20 ST	
Type	WAP 16+35 WTW 2.5-10 BL	Version
Order No.	1050180000	End and partition plate for terminals, blue, Height: 56 mm, Width: 1.5
GTIN (EAN)	4008190013899	mm, V-0, Wemid
Qty.	20 ST	

WDU 35 SW

Weidmüller Interface GmbH & Co. KG

Klingenbergstraße 26

D-32758 Detmold

Germany

www.weidmueller.com

Accessories

W-Series



Series

Weidmüller's range of products includes end brackets that guarantee a permanent, reliable mounting on the terminal rail and prevent sliding. Versions with and without screws are available. The end brackets include marking options, also for group markers, and also a test plug holder.

General ordering data

Type	WEW 35/1	Version	
Order No.	1059000000	End bracket, dark beige, TS 35, V-2, Wemid, Width: 12 mm, 100 °C	
GTIN (EAN)	4008190172282		
Qty.	50 ST		

Blank



The Dekafix (DEK) marker is the universal marker for all conductor and plug-in connectors as well as for electronic sub-assemblies. The system is ideal for short number sequences and covers a wide range of ready-printed markers.

Strips for fast installation in only one work step. The printing is easy to read, rich in contrast and available in various widths.

- Large range of ready-to-use markers
 - Strips for fast installation
 - Terminal markers, suitable for all Weidmüller cable connectors
 - Available as blank MultiCard or with standard printing
- For custom printing: Please send us a file of our labeling software M-Print PRO or M-Print PRO Online (without installation) for your labeling specifications.

General ordering data

Type	DEK 5/5 MC NE WS	Version	
Order No.	1609801044	Dekafix, Terminal marker, 5 x 5 mm, Pitch in mm (P): 5.00	
GTIN (EAN)	4008190397111	Weidmueller, white	
Qty.	1000 ST		
Type	WS 12/5 MC NE WS	Version	
Order No.	1609860000	WS, Terminal marker, 12 x 5 mm, Pitch in mm (P): 5.00 Weidmueller,	
GTIN (EAN)	4008190203481	Allen-Bradley, white	
Qty.	720 ST		

WDU 35 SW

Weidmüller Interface GmbH & Co. KG

Klingenbergstraße 26
D-32758 Detmold
Germany

www.weidmueller.com

Accessories

SchT group marker carrier

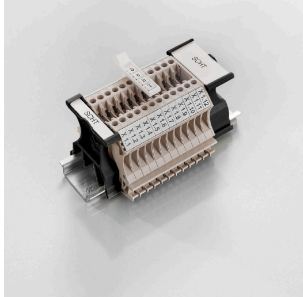

The SchT 5 S group tag carriers are clipped directly onto the TS 32 mounting rail (G-rail) or the TS 35 mounting rail (top-hat rail). It is therefore possible to label the terminal strip irrespective of the terminal and the type of terminal. SchT 5 and SchT 5 S are fitted with ESO 5, STR 5 protective strips.

The SchT 7 is a hinged group tag carrier for inlay tags which enables easy access to the clamping screw. The SchT 7 is fitted with ESO 7, STR 7 protective strips or DEK 5.

Inlay tags and protective strips can be found under "Accessories".

General ordering data

Type	SCHT 7	Version	
Order No.	0517960000	SCHT, Terminal marker, 39.3 x 8 mm, Pitch in mm (P): 7.00	
GTIN (EAN)	4008190001742	Weidmueller, white	
Qty.	20 ST		

ZGB pivotable group tag holder

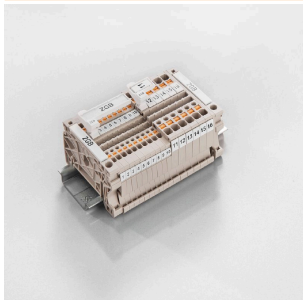

The ZGB 15 is a hinged group tag carrier. The tag carrier can hold the dekafix 5, WS 12/5 terminal markers or the inlay tag ESO 15.

The ZGB 30 is a hinged group tag carrier. The tag carrier can hold the dekafix 5, WS 12/5 terminal markers or the inlay tag ESO 7.

Inlay tags and protective strips can be found under "Accessories".

General ordering data

Type	ZGB 15	Version	
Order No.	1636530000	Terminal markers, Terminal marker, 15 x 7 mm, Pitch in mm (P): 5.00	
GTIN (EAN)	4008190297053	Weidmueller, white	
Qty.	20 ST		
Type	ZGB 30	Version	
Order No.	1611930000	Terminal markers, Terminal marker, 32 x 7 mm, Pitch in mm (P): 5.00	
GTIN (EAN)	4008190002251	Weidmueller, white	
Qty.	20 ST		

WDU 35 SW

Weidmüller Interface GmbH & Co. KG
 Klingenbergstraße 26
 D-32758 Detmold
 Germany

www.weidmueller.com

Accessories

W-Series



A partition plate is used for the optical separation of circuits or used for electrical isolation from neighbouring cross-connectors. In contrast to the end plate, the contour can be larger than the adjacent terminal blocks. However, it should not be smaller, as otherwise the required clearance and creepage distances within the application can no longer be maintained.

General ordering data

Type	WTW EN	Version	
Order No.	1058800000	Partition plate (terminal), dark beige, Height: 86 mm, Width: 3 mm,	
GTIN (EAN)	4008190140175	V-0, Wemid	
Qty.	20 ST		

Blank

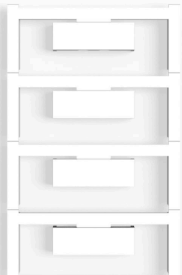

The WAD connector marker is suitable for W-series terminals and for the WEW 35/2 and ZEW 35/2 end brackets. The markers are available as blank markers, with custom printing or standard print with lightning symbol. The WAD MultiCard markers are suitable for labelling with PrintJet CONNECT printers. For custom printing: Please send us a file of our labeling software M-Print PRO or M-Print PRO Online (without installation) for your labeling specifications.

General ordering data

Type	WAD 12 MC NE GE	Version	
Order No.	2445080000	Group markers, Cover, 36.2 x 11.9 mm, WDU 16, WDU 35, yellow	
GTIN (EAN)	4050118458213		
Qty.	32 ST		
Type	WAD 12 MC NE WS	Version	
Order No.	2445070000	Group markers, Cover, 36.2 x 11.9 mm, WDU 16, WDU 35, white	
GTIN (EAN)	4050118458220		
Qty.	32 ST		

With lightning flash

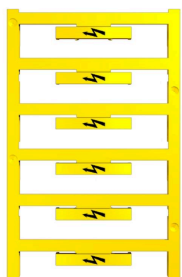

The WAD connector marker is suitable for W-series terminals and for the WEW 35/2 and ZEW 35/2 end brackets. The markers are available as blank markers, with custom printing or standard print with lightning symbol. The WAD MultiCard markers are suitable for labelling with PrintJet CONNECT printers. For custom printing: Please send us a file of our labeling software M-Print PRO or M-Print PRO Online (without installation) for your labeling specifications.

WDU 35 SW

Weidmüller Interface GmbH & Co. KG
 Klingenbergstraße 26
 D-32758 Detmold
 Germany

www.weidmueller.com

Accessories

General ordering data

Type	WAD 12 MC B GE/SW	Version	
Order No.	2445090000	Group markers, Cover, 36.2 x 11.9 mm, WDU 16, WDU 35, yellow	
GTIN (EAN)	4050118457896		
Qty.	32 ST		

Testsockets

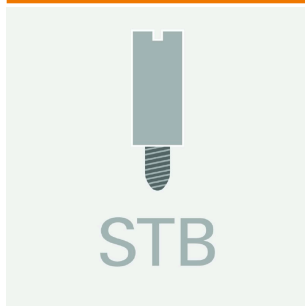

Test adapters and test plugs are used for the electrical connection between terminal blocks and the test equipment. In this way, an electrical contact can be established in the wired state and measurements can be done easily.

General ordering data

Type	STB 14/D6/4/M3 SAK10	Version	
Order No.	0169900000	Accessories, Socket	
GTIN (EAN)	4008190076665		
Qty.	50 ST		
Type	STB 16/D7/4/M4 SAK35	Version	
Order No.	0140200000	SAK Series, Socket	
GTIN (EAN)	4008190134884		
Qty.	50 ST		

Marker holder

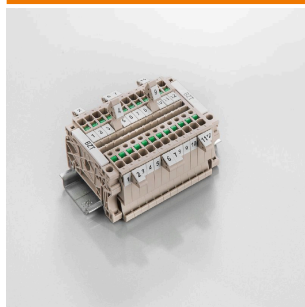

The marker holder offer the possibility of additional mounting of standard markers with a pitch of 5 or 5.1 mm. The angled holders can be optionally snapped together and could be mounted in all standard marking channels of the Klippon® Connect modular terminal blocks. Fitting marker types could be found under the respective accessories of the designation marking holder.

General ordering data

Type	BZT 1 WS 10/5	Version	
Order No.	1805490000	Accessories, Marker holder	
GTIN (EAN)	4032248270231		
Qty.	100 ST		
Type	BZT 1 ZA WS 10/5	Version	
Order No.	1805520000	Accessories, Marker holder	
GTIN (EAN)	4032248270248		
Qty.	100 ST		

WDU 35 SW

Weidmüller Interface GmbH & Co. KG
 Klingenbergstraße 26
 D-32758 Detmold
 Germany

www.weidmueller.com

Accessories

Step-down bridges

General ordering data

Type	WQV 35-10/6/4	Version	
Order No.	1068000000	Cross-connector (terminal), when screwed in, yellow, 57 A, Number of poles: 2, Pitch in mm (P): 16.00, Insulated: Yes, Width: 13 mm	
GTIN (EAN)	4008190141011		
Qty.	10 ST		
Type	WQV 35-2.5	Version	
Order No.	1064100000	Cross-connector (terminal), when screwed in, yellow, 41 A, Number of poles: 3, Pitch in mm (P): 16.00, Insulated: Yes, Width: 13 mm	
GTIN (EAN)	4008190142285		
Qty.	10 ST		

WS 12/5



WS/ DEK

MultiMark terminal markers use an innovative composite material made from two components. The hard base contour of the marker snaps securely into the connector. The elastic surface finish makes the marker easy to mount. This specially punched material enables the strips to be stretched to accommodate the slight variations in spacing that tend to add up, especially with long terminal blocks. Another advantage: the excellent printability of the surface material guarantees durable and wear-resistant labelling. A print resolution of 300 dpi also produces a very legible script.

Your benefits with MultiMark

- Firm hold and durable printing
- Continuous strips save installation time
- Easy mounting thanks to an innovative composite material
- Large label field for optimal legibility
- High flexibility thanks to manufacturer independence

General ordering data

Type	WS 12/5 MM WS	Version	
Order No.	2007190000	WS, Terminal marker, 12 x 5 mm, Weidmueller, white	
GTIN (EAN)	4050118392036		
Qty.	800 ST		

WDU 35 SW

Weidmüller Interface GmbH & Co. KG
Klingenbergstraße 26
D-32758 Detmold
Germany

www.weidmueller.com

Accessories

PEN bridges



Power feed-in

Our wide range of W-Series terminal blocks with our WPD main line branch terminals, which are optimised to guarantee both convenience and space gains, ensures a secure and convenient connection at the power feed-in.

General ordering data

Type	WQB-PEN 35	Version	
Order No.	1060100000	Cross-connector (terminal), when screwed in, Silver grey, 135 A,	
GTIN (EAN)	4008190089870	Number of poles: 2, Pitch in mm (P): 16.00, Insulated: No, Width:	
Qty.	10 ST	24.6 mm	