

**OMNIMATE Signal - series BL/SL 5.08
SLD 5.08V/22/90B 3.2 SN OR BX**

Weidmüller Interface GmbH & Co. KG
Klingenbergstraße 16
D-32758 Detmold
Germany
Fon: +49 5231 1429-0
Fax: +49 5231 14292083
www.weidmueller.com

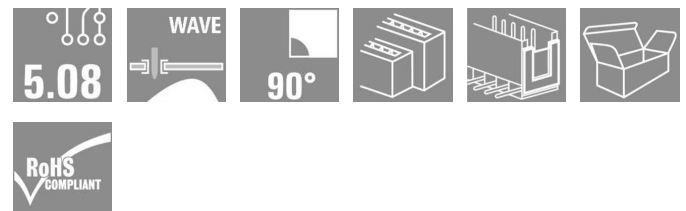

Pin headers with solder pin length optimised for wave flow soldering. The male connectors provide space for labelling and can be coded. HC = High Current.

General ordering data

Available until	2010-05-31
Type	SLD 5.08V/22/90B 3.2 SN OR BX
Order No.	1726370000
Version	PCB plug-in connector, male header, Dovetails for fixing blocks, THT solder connection, 5.08 mm, No. of poles: 22, 90°, Solder pin length (l): 3.2 mm, tinned, Orange, Box
GTIN (EAN)	4032248061341
Qty.	10 pc(s).
Product data	IEC: 400 V / 17 A UL: 300 V / 10 A
Packaging	Box

**OMNIMATE Signal - series BL/SL 5.08
SLD 5.08V/22/90B 3.2 SN OR BX**

Weidmüller Interface GmbH & Co. KG
Klingenbergstraße 16
D-32758 Detmold
Germany
Fon: +49 5231 1429-0
Fax: +49 5231 14292083
www.weidmueller.com

Technical data**Dimensions and weights**

Net weight 18.395 g

System specifications

Product family		Mounting onto the PCB	
OMNIMATE Signal - series BL/SL 5.08		THT solder connection	
Pitch in mm (P)	5.08 mm	Pitch in inches (P)	0.2 inch
Outgoing elbow	90°	No. of poles	22
Number of solder pins per pole	1	Solder pin length (l)	3.2 mm
Solder pin length tolerance	+0.1 / -0.3 mm	Tolerance of solder pin position	± 0.15 mm
Solder pin dimensions	d = 1.2 mm, Octagonal	Solder pin dimensions = d tolerance	0 / -0,03 mm
Solder eyelet hole diameter (D)	1.3 mm	Solder eyelet hole diameter tolerance (D)	+ 0,1 mm
L1 in mm	106.68 mm	L1 in inches	4.2 inch
Number of rows	2	Pin series quantity	2
Can be coded	Yes	Plugging cycles	25
Packaging	Box		

Material data

Insulating material	PBT	Colour	Orange
Colour chart (similar)	RAL 2000	Insulating material group	IIIa
CTI	≥ 200	Insulation resistance	≥ 10 ⁸ Ω
UL 94 flammability rating	V-0	Contact material	CuSn
Contact surface	tinned	Layer structure of solder connection	1-3 µm Ni / 2-4 µm Sn matt
Layer structure of plug contact	1-3 µm Ni / 2-4 µm Sn matt	Storage temperature, min.	-25 °C
Storage temperature, max.	55 °C	Max. relative humidity during storage	80 %
Operating temperature, min.	-50 °C	Operating temperature, max.	100 °C
Temperature range, installation, min.	-25 °C	Temperature range, installation, max.	100 °C

Rated data acc. to IEC

tested acc. to standard	IEC 60664-1, IEC 61984	Rated current, min. no. of poles (Ta = 20°C)	17 A
Rated current, min. no. of poles (Ta = 40°C)	15 A	Rated voltage for surge voltage class / pollution degree II/2	400 V
Rated voltage for surge voltage class / pollution degree III/2	320 V	Rated voltage for surge voltage class / pollution degree III/3	250 V
Rated impulse voltage for surge voltage class/ pollution degree II/2	4 kV	Rated impulse voltage for surge voltage class/ pollution degree III/2	4 kV
Rated impulse voltage for surge voltage class/ contamination degree III/3	4 kV		

Rated data acc. to CSA

Institute (CSA)		Certificate No. (CSA)	200039-1121690
Rated voltage (Use group B)	300 V	Rated voltage (use group D)	300 V
Rated current (use group B)	10 A	Rated current (use group D)	10 A
Reference to approval values	Specifications are maximum values, details - see approval certificate.		

Creation date October 12, 2016 10:08:59 AM CEST

Catalogue status 07.10.2016 / We reserve the right to make technical changes.

**OMNIMATE Signal - series BL/SL 5.08
SLD 5.08V/22/90B 3.2 SN OR BX**

Weidmüller Interface GmbH & Co. KG
 Klingenbergstraße 16
 D-32758 Detmold
 Germany
 Fon: +49 5231 1429-0
 Fax: +49 5231 14292083
 www.weidmueller.com

Technical data**Rated data acc. to UL 1059**

Institute (UR)



Certificate No. (UR)

E60693

Rated voltage (use group B)	300 V
Rated current (use group B)	10 A
Reference to approval values	Specifications are maximum values, details - see approval certificate.

Rated voltage (use group D)	300 V
Rated current (use group D)	10 A

Classifications

ETIM 3.0	EC001284	ETIM 4.0	EC002637
ETIM 5.0	EC002637	ETIM 6.0	EC002637
UNSPSC	30-21-18-10	eClass 5.1	27-26-07-04
eClass 6.2	27-26-07-04	eClass 7.1	27-44-04-02
eClass 8.1	27-44-04-02	eClass 9.0	27-44-04-02

Notes

Notes

- Additional colours on request
- Rated current related to rated cross-section & min. No. of poles.
- Spacing between rows: see hole layout
- P on drawing = pitch
- Rated data refer only to the component itself. Clearance and creepage distances to other components are to be designed in accordance with the relevant application standards.

IPC conformity

The products are developed, manufactured and delivered according to the internationally recognised IPC-A-610 standard, category "permissible". More extensive demands on the products can be evaluated on request.

Approvals

Approvals



ROHS

Conform

Downloads

EDA Layout Library (Mentor Graphics Expedition, Mentor Graphics Pads, Altium Designer)

[Select your download](#)

Safety notice

[Safety indication](#)

Data sheet

**OMNIMATE Signal - series BL/SL 5.08
SLD 5.08V/22/90B 3.2 SN OR BX**

Weidmüller Interface GmbH & Co. KG
 Klingenbergstraße 16
 D-32758 Detmold
 Germany
 Fon: +49 5231 1429-0
 Fax: +49 5231 14292083
 www.weidmueller.com

Drawings

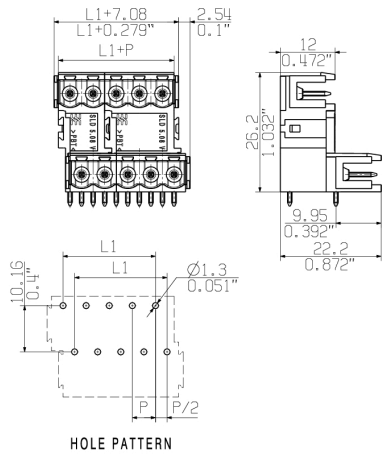

**OMNIMATE Signal - series BL/SL 5.08
SLD 5.08V/22/90B 3.2 SN OR BX**

Weidmüller Interface GmbH & Co. KG
Klingenbergstraße 16
D-32758 Detmold
Germany
Fon: +49 5231 1429-0
Fax: +49 5231 14292083
www.weidmueller.com

Mating connector (fully pluggable)
BLDT 5.08B

Female plugs with two clamping-yoke screw connections per pole for wire connections with 90° and 270° outlet directions. The female plugs provide space for labelling and can be coded.

General ordering data

Type	Order No.	Version	GTIN (EAN)	Qty.	Product data	Packaging
BLDT 5.08/11/-B SN OR BX	1651830000	PCB plug-in connector, female plug, 5.08 mm, No. of poles: 11, 180°, Clamping yoke connection, Clamping range, rated connection, max.: 3.31 mm ² , Box	4008190400514	25 pc(s).	IEC: 400 V / 14 A / 0.2 - 2.5 mm ² UL: 300 V / 10 A / AWG 26 - AWG 12	Box
Discontinued	2014-05-20T00:00:00+02:00	BLDT 5.08/11/-B SN BK BX	1673870000	PCB plug-in connector, female plug, 5.08 mm, No. of poles: 11, 180°, Clamping yoke connection, Clamping range, rated connection, max.: 3.31 mm ² , Box	4008190435608	25 pc(s).

BLZP 5.08HC/225 SN

Clamping-yoke connection with right-angled (90° or 270°) or angled (225°) outlet direction. The female connectors provide space for labelling and can be coded. Fastened by means of a flange or release latch. They also provide an integrated plus/minus screw, protection against faulty insertion of the wire, and they are delivered with open clamping yokes. HC = High Current.

General ordering data

Delivery status	Available until	Type	Order No.	Version	GTIN (EAN)	Qty.
Discontinued	2016-04-08T00:00:00+02:00	BLZP 5.08HC/11/225 SN BK BX	1946650000	PCB plug-in connector, female plug, 5.08 mm, No. of poles: 11, 225°, Clamping yoke connection, Clamping range,	4032248622429	30 pc(s).

**OMNIMATE Signal - series BL/SL 5.08
SLD 5.08V/22/90B 3.2 SN OR BX**

Weidmüller Interface GmbH & Co. KG
Klingenbergstraße 16
D-32758 Detmold
Germany
Fon: +49 5231 1429-0
Fax: +49 5231 14292083
www.weidmueller.com

Mating connector (fully pluggable)

rated connection,
max.: 4 mm², Box

BLZP 5.08HC/11/225 SN OR BX	1946340000	PCB plug-in connector, female plug, 5.08 mm, No. of poles: 11, 225°, Clamping yoke connection, Clamping range, rated connection, max.: 4 mm ² , Box	4032248622115 30 pc(s).	IEC: 400 V / 17.5 A / 0.2 - 4 mm ² UL: 300 V / 15 A / AWG 30 - AWG 12	Box
-----------------------------------	----------------------------	--	-------------------------	---	-----

BLZP 5.08HC/225B SN



Clamping-yoke connection with right-angled (90° or 270°) or angled (225°) outlet direction. The female connectors provide space for labelling and can be coded. Fastened by means of a flange or release latch. They also provide an integrated plus/minus screw, protection against faulty insertion of the wire, and they are delivered with open clamping yokes. HC = High Current.

General ordering data

Delivery status	Available until	Type	Order No.	Version	GTIN (EAN)	Qty.
Discontinued	2016-04-08T00:00:00+02:00	BLZP 5.08HC/11/225B SN BK BX	1946070000	PCB plug-in connector, female plug, 5.08 mm, No. of poles: 11, 225°, Clamping yoke connection, Clamping range, rated connection, max.: 4 mm ² , Box	4032248621606	30 pc(s)
BLZP	1945840000	PCB plug-in connector, female plug, 5.08 mm, No. of poles: 11, 225°, Clamping yoke connection, Clamping range, rated connection, max.: 4 mm ² , Box	4032248621316 30 pc(s).	IEC: 400 V / 17.5 A / 0.2 - 4 mm ² UL: 300 V / 15 A / AWG 30 - AWG 12	Box	

OMNIMATE Signal - series BL/SL 5.08 SLD 5.08V/22/90B 3.2 SN OR BX

Weidmüller Interface GmbH & Co. KG
Klingenbergstraße 16
D-32758 Detmold
Germany
Fon: +49 5231 1429-0
Fax: +49 5231 14292083
www.weidmueller.com

Mating connector (fully pluggable)

BLZP 5.08HC/270 SN



Female plugs with clamping-yoke connection for connecting wires with a right-angle (90° or 270°) outlet direction. The female connectors provide space for labelling and can be coded. Fastened by means of a flange or release latch. They also provide an integrated plus/minus screw, protection against faulty insertion of the wire, and they are delivered with open clamping yokes. HC = High Current.

General ordering data

Type	Order No.	Version	GTIN (EAN)	Qty.	Product data	Packaging
BLZP 5.08HC/11/270 SN BK BX	1949110000	PCB plug-in connector, female plug, 5.08 mm, No. of poles: 11, 270°, Clamping yoke connection, Clamping range, rated connection, max.: 4 mm², Box	4032248626564	30 pc(s).	IEC: 400 V / 23 A / 0.2 - 4 mm² UL: 300 V / 20 A / AWG 30 - AWG 12	Box
BLZP 5.08HC/11/270 SN OR BX	1948880000	PCB plug-in connector, female plug, 5.08 mm, No. of poles: 11, 270°, Clamping yoke connection, Clamping range, rated connection, max.: 4 mm², Box	4032248626335	30 pc(s).	IEC: 400 V / 23 A / 0.2 - 4 mm² UL: 300 V / 20 A / AWG 30 - AWG 12	Box

BLF 5.08HC/90 SN



Just as reliable as the millionfold proven original and featuring innovative details:

The BLF 5.08HC PUSH IN version of the BLZP 5.08HC female connector is not only different in terms of connection system; it also has a more compact design. Weidmüller's innovative PUSH IN spring connection system stands for the future of easy and tool-free wire connection. HC = High Current.

In terms of versatility, the BLF 5.08HC offers just as much as the version which served as a model:

- 3 tested-and-proven wire outlet directions provide the usual flexibility for application-specific design
- 4 flange variations and the patented release latch allow the locking concept to be based on the requirements of the user
- Use the BLF 5.08HC and SL 5.08HC plug combination to reach the max. rated specifications

General ordering data

Type	Order No.	Version	GTIN (EAN)	Qty.	Product data	Packaging
BLF 5.08HC/11/90 SN BK BX	1000120001	PCB plug-in connector, female plug, 5.08 mm, No. of poles: 11, 90°, PUSH	4032248690060	30 pc(s).	IEC: 400 V / 24 A / 0.2 - 2.5 mm² UL: 300 V / 18.5 A / AWG 26 - AWG 12	Box

OMNIMATE Signal - series BL/SL 5.08 SLD 5.08V/22/90B 3.2 SN OR BX

Weidmüller Interface GmbH & Co. KG
 Klingenbergstraße 16
 D-32758 Detmold
 Germany
 Fon: +49 5231 1429-0
 Fax: +49 5231 14292083
 www.weidmueller.com

Mating connector (fully pluggable)

		IN, Clamping range, rated connection, max.: 3.31 mm ² , Box		
BLF	1001620000	PCB plug-in connector, female plug, 5.08 mm, No. of poles: 11, 90°, PUSH	4032248693429 30 pc(s).	IEC: 400 V / 24 A / 0.2 - 2.5 mm ² UL: 300 V / 18.5 A / AWG 26 - AWG 12
5.08HC/11/90 SN OR BX		IN, Clamping range, rated connection, max.: 3.31 mm ² , Box		

BLZP 5.08HC/90 SN



Female plugs with clamping-yoke connection for connecting wires with a right-angle (90° or 270°) outlet direction. The female connectors provide space for labelling and can be coded. Fastened by means of a flange or release latch. They also provide an integrated plus/minus screw, protection against faulty insertion of the wire, and they are delivered with open clamping yokes. HC = High Current.

General ordering data

Type	Order No.	Version	GTIN (EAN)	Qty.	Product data	Packaging
BLZP	1948100000	PCB plug-in connector, female plug, 5.08 mm, No. of poles: 11, 90°, Clamping yoke connection, Clamping range, rated connection, max.: 4 mm ² , Box	4032248624522 30 pc(s).		IEC: 400 V / 23 A / 0.2 - 4 mm ² UL: 300 V / 20 A / AWG 30 - AWG 12	Box
5.08HC/11/90 SN OR BX						
Discontinued	2016-04-08T00:00:00+02:00	BLZP 5.08HC/11/90 SN BK BX	1948330000	PCB plug-in connector, female plug, 5.08 mm, No. of poles: 11, 90°, Clamping yoke connection, Clamping range, rated connection, max.: 4 mm ² , Box	4032248624850	30 pc(s).

**OMNIMATE Signal - series BL/SL 5.08
SLD 5.08V/22/90B 3.2 SN OR BX**

Weidmüller Interface GmbH & Co. KG
Klingenbergstraße 16
D-32758 Detmold
Germany
Fon: +49 5231 1429-0
Fax: +49 5231 14292083
www.weidmueller.com

Mating connector (fully pluggable)
BLZP 5.08HC/180 SN

Female plug with clamping-yoke screw system for connecting wires with straight (180°) outlet direction. The female connectors provide space for labelling and can be coded. Fastened by means of a flange or release latch. They also provide an integrated plus/minus screw, protection against faulty insertion of the wire, and they are delivered with open clamping yokes. HC = High Current.

General ordering data

Type	Order No.	Version	GTIN (EAN)	Qty.	Product data	Packaging
BLZP 5.08HC/11/180 SN OR BX	1943670000	PCB plug-in connector, female plug, 5.08 mm, No. of poles: 11, 180°, Clamping yoke connection, Clamping range, rated connection, max.: 4 mm², Box	4032248617685	30 pc(s).	IEC: 400 V / 23 A / 0.2 - 4 mm² UL: 300 V / 20 A / AWG 30 - AWG 12	Box
BLZP 5.08HC/11/180 SN BK BX	1943900000	PCB plug-in connector, female plug, 5.08 mm, No. of poles: 11, 180°, Clamping yoke connection, Clamping range, rated connection, max.: 4 mm², Box	4032248618026	30 pc(s).	IEC: 400 V / 23 A / 0.2 - 4 mm² UL: 300 V / 20 A / AWG 30 - AWG 12	Box

BLF 5.08HC/270 SN

Just as reliable as the millionfold proven original and featuring innovative details:
The BLF 5.08HC PUSH IN version of the BLZP 5.08HC female connector is not only different in terms of connection system; it also has a more compact design. Weidmüller's innovative PUSH IN spring connection system stands for the future of easy and tool-free wire connection. HC = High Current.
In terms of versatility, the BLF 5.08HC offers just as much as the version which served as a model:

- 3 tested-and-proven wire outlet directions provide the usual flexibility for application-specific design
- 4 flange variations and the patented release latch allow the locking concept to be based on the requirements of the user
- Use the BLF 5.08HC and SL 5.08HC plug combination to reach the max. rated specifications

General ordering data

Delivery status	Available until	Type	Order No.	Version	GTIN (EAN)	Qty.
Discontinued	2016-04-08T00:00:00+02:00	BLF 5.08HC/11/270 SN BK BX	1982020000	PCB plug-in connector, female plug, 5.08 mm,	4032248685714	30 pc(s).

**OMNIMATE Signal - series BL/SL 5.08
SLD 5.08V/22/90B 3.2 SN OR BX**

Weidmüller Interface GmbH & Co. KG
Klingenbergstraße 16
D-32758 Detmold
Germany
Fon: +49 5231 1429-0
Fax: +49 5231 14292083
www.weidmueller.com

Mating connector (fully pluggable)

No. of poles: 11,
270°, PUSH IN,
Clamping range,
rated connection,
max.: 3.31 mm²,
Box

BLF 5.08HC/11/270 SN OR BX	1982790000	PCB plug-in connector, female plug, 5.08 mm, No. of poles: 11, 270°, PUSH IN, Clamping range, rated connection, max.: 3.31 mm ² , Box	4032248686889 30 pc(s).	IEC: 400 V / 24 A / 0.2 - 2.5 mm ² UL: 300 V / 18.5 A / AWG 26 - AWG 12	Box
----------------------------------	----------------------------	---	-------------------------	--	-----

BLDT 5.08



Female plugs with two clamping-yoke screw connections per pole for wire connections with 90° and 270° outlet directions. The female plugs provide space for labelling and can be coded.

General ordering data

Type	Order No.	Version	GTIN (EAN)	Qty.	Product data	Packaging
BLDT 5.08/11/- SN OR BX	1644820000	PCB plug-in connector, female plug, 5.08 mm, No. of poles: 11, 180°, Clamping yoke connection, Clamping range, rated connection, max.: 3.31 mm ² , Box	4008190284039	25 pc(s).	IEC: 400 V / 14 A / 0.2 - 2.5 mm ² UL: 300 V / 10 A / AWG 26 - AWG 12	Box
Discontinued	2014-05-20T00:00:00+02:00	BLDT 5.08/11/- SN BK BX	1660800000	PCB plug-in connector, female plug, 5.08 mm, No. of poles: 11, 180°, Clamping yoke connection, Clamping range, rated connection, max.: 3.31 mm ² , Box	4008190417253	25 pc(s).

**OMNIMATE Signal - series BL/SL 5.08
SLD 5.08V/22/90B 3.2 SN OR BX**

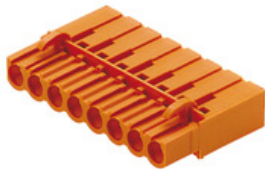
Weidmüller Interface GmbH & Co. KG
Klingenbergstraße 16
D-32758 Detmold
Germany
Fon: +49 5231 1429-0
Fax: +49 5231 14292083
www.weidmueller.com

Mating connector (fully pluggable)
BLC 5.08R

Female plugs with crimp wire connection system. The female plugs provide space for labelling and can be coded.

General ordering data

Type	Order No.	Version	GTIN (EAN)	Qty.	Product data	Packaging
BLC 5.08/11/180R OR BX	1610580000	PCB plug-in connector, female plug, 5.08 mm, No. of poles: 11, 180°, Crimp connection, Clamping range, rated connection, max.: 2.5 mm ² , Box	4008190059903	50 pc(s).	IEC: 400 V / 21 A UL: 300 V / 10 A / AWG 26 - AWG 14	Box
Discontinued	2014-05-20T00:00:00+02:00	BLC 5.08/11/180R BK BX	1712050000	PCB plug-in connector, female plug, 5.08 mm, No. of poles: 11, 180°, Crimp connection, Clamping range, rated connection, max.: 2.5 mm ² , Box	4008190935061	50 pc(s).

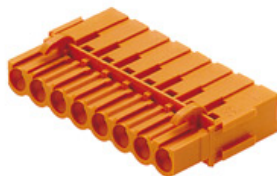
BLC 5.08BR

Female plugs with crimp wire connection system. The female plugs provide space for labelling and can be coded.

General ordering data

Delivery status	Available until	Type	Order No.	Version	GTIN (EAN)	Qty.
This article will no longer be available in the future.	2016-09-01T00:00:00+02:00	BLC 5.08/11/180BR BK BX	1712200000	PCB plug-in connector, female plug, 5.08 mm, No. of poles: 11, 180°, Crimp connection, Clamping range, rated connection,	4008190935214	50 pc(s).

**OMNIMATE Signal - series BL/SL 5.08
SLD 5.08V/22/90B 3.2 SN OR BX**

Weidmüller Interface GmbH & Co. KG
Klingenbergstraße 16
D-32758 Detmold
Germany
Fon: +49 5231 1429-0
Fax: +49 5231 14292083
www.weidmueller.com

Mating connector (fully pluggable)

max.: 2.5 mm²,
Box

BLC 5.08/11/180BR OR BX	1649460000	PCB plug-in connector, female plug, 5.08 mm, No. of poles: 11, 180°, Crimp connection, Clamping range, rated connection, max.: 2.5 mm ² , Box	4008190294571 50 pc(s).	IEC: 400 V / 21 A UL: 300 V / 10 A / AWG 26 - AWG 14	Box
-------------------------------	----------------------------	---	-------------------------	---	-----

BLF 5.08HC/180 SN

Just as reliable as the millionfold proven original and featuring innovative details:

The BLF 5.08HC PUSH IN version of the BLZP 5.08HC female connector is not only different in terms of connection system; it also has a more compact design. Weidmüller's innovative PUSH IN spring connection system stands for the future of easy and tool-free wire connection. HC = High Current.

In terms of versatility, the BLF 5.08HC offers just as much as the version which served as a model:

- 3 tested-and-proven wire outlet directions provide the usual flexibility for application-specific design
- 4 flange variations and the patented release latch allow the locking concept to be based on the requirements of the user
- Use the BLF 5.08HC and SL 5.08HC plug combination to reach the max. rated specifications

General ordering data

Type	Order No.	Version	GTIN (EAN)	Qty.	Product data	Packaging
BLF 5.08HC/11/180 SN BK BX	1013530000	PCB plug-in connector, female plug, 5.08 mm, No. of poles: 11, 180°, PUSH IN, Clamping range, rated connection, max.: 3.31 mm ² , Box	4032248721672 30 pc(s).		IEC: 400 V / 24 A / 0.2 - 2.5 mm ² UL: 300 V / 18.5 A / AWG 26 - AWG 12	Box
BLF 5.08HC/11/180 SN OR BX	1013780000	PCB plug-in connector, female plug, 5.08 mm, No. of poles: 11, 180°, PUSH IN, Clamping range, rated connection, max.: 3.31 mm ² , Box	4032248721894 30 pc(s).		IEC: 400 V / 24 A / 0.2 - 2.5 mm ² UL: 300 V / 18.5 A / AWG 26 - AWG 12	Box

**OMNIMATE Signal - series BL/SL 5.08
SLD 5.08V/22/90B 3.2 SN OR BX**

Weidmüller Interface GmbH & Co. KG
Klingenbergstraße 16
D-32758 Detmold
Germany
Fon: +49 5231 1429-0
Fax: +49 5231 14292083
www.weidmueller.com

Mating connector (fully pluggable)
BLL 5.08/180

Female header for PCB mounting. The solder pin length is optimised for wave flow soldering.

General ordering data

Type	Order No.	Version	GTIN (EAN)	Qty.	Product data	Packaging
BLL 5.08/11/180 3.2 SN OR BX	1630800000	PCB plug-in connector, female header, closed side, THT solder connection, 5.08 mm, No. of poles: 11, 180°, Solder pin length (l): 3.2 mm, tinned, Orange, Box	4008190204235	30 pc(s).	IEC: 400 V / 23 A UL: 300 V / 15 A	Box

BLL 5.08/180B

Female header for PCB mounting. The solder pin length is optimised for wave flow soldering.

General ordering data

Type	Order No.	Version	GTIN (EAN)	Qty.	Product data	Packaging
BLL 5.08/11/180B 3.2SN OR BX	1682820000	PCB plug-in connector, female header, Dovetails for fixing blocks, THT solder connection, 5.08 mm, No. of poles: 11, 180°, Solder pin length (l): 3.2 mm, tinned, Orange, Box	4008190474584	30 pc(s).	IEC: 400 V / 23 A UL: 300 V / 15 A	Box

**OMNIMATE Signal - series BL/SL 5.08
SLD 5.08V/22/90B 3.2 SN OR BX**

Weidmüller Interface GmbH & Co. KG
 Klingenbergstraße 16
 D-32758 Detmold
 Germany
 Fon: +49 5231 1429-0
 Fax: +49 5231 14292083
 www.weidmueller.com

Mating connector (fully pluggable)
BLL 5.08/90

Female header for PCB mounting. The solder pin length is optimised for wave flow soldering.

General ordering data

Type	Order No.	Version	GTIN (EAN)	Qty.	Product data	Packaging
BLL	1623030000	PCB plug-in connector, female header, closed side, THT solder connection, 5.08 mm, No. of poles: 11, 90°, Solder pin length (l): 3.2 mm, tinned, Orange, Box	4008190194086	30 pc(s).	IEC: 400 V / 23 A UL: 300 V / 15 A	Box

**OMNIMATE Signal - series BL/SL 5.08
SLD 5.08V/22/90B 3.2 SN OR BX**

Weidmüller Interface GmbH & Co. KG
 Klingenbergstraße 16
 D-32758 Detmold
 Germany
 Fon: +49 5231 1429-0
 Fax: +49 5231 14292083
 www.weidmueller.com

Accessories**Blocks for PCB mounting****Minor component, major effect:**

Clip-on attachment elements increase the mechanical resilience of the whole plug connection by

- securing the male connectors to the circuit board
- providing a vibration-proof connection between the sockets and the male connectors

Clip-on or pre-assembled - always the right solution:

- Hard-wearing, precise fitting dovetail joint
- Hard-wearing metal threaded inserts
- Suitable for all outlet directions

Maximum stability, minimum effort:

- Extremely resilient for frequent fastening operations
- Complete set for easy selection

The result: soldering points, contacts and overall module are more resilient against mechanical stress such as vibrations and tensile loads.

General ordering data

Type	Order No.	Version	GTIN (EAN)	Qty.	Product data
SLA BB6R SW	1723520000	PCB plug-in connector, Accessories, Mounting block, Black, No. of poles: 1	4008190366070	20 pc(s).	
SLA BB6R OR	1723470000	PCB plug-in connector, Accessories, Mounting block, Orange, No. of poles: 1	4008190366025	20 pc(s).	
SLA BB11R OR	1604120000	PCB plug-in connector, Accessories, Mounting block, Orange, No. of poles: 1	4008190182977	20 pc(s).	
SLA BB11R SW	1692340000	PCB plug-in connector, Accessories, Mounting block, Black, No. of poles: 1	4008190864965	20 pc(s).	
SLA BB12R SW	1626880000	PCB plug-in connector, Accessories, Mounting block, Black, No. of poles: 1	4008190198213	100 pc(s).	
SLA BB1R OR	1723430000	PCB plug-in connector, Accessories, Mounting block, Orange, No. of poles: 1	4008190365981	20 pc(s).	
SLA BB5R OR	1723460000	PCB plug-in connector, Accessories, Mounting block, Orange, No. of poles: 1	4008190366018	20 pc(s).	
SLA BB1R SW	1723480000	PCB plug-in connector, Accessories, Mounting block, Black, No. of poles: 1	4008190366032	20 pc(s).	
SLA BB2R OR	1723440000	PCB plug-in connector, Accessories, Mounting	4008190365998	20 pc(s).	

Creation date October 12, 2016 10:09:00 AM CEST

OMNIMATE Signal - series BL/SL 5.08 SLD 5.08V/22/90B 3.2 SN OR BX

Weidmüller Interface GmbH & Co. KG
 Klingenbergstraße 16
 D-32758 Detmold
 Germany
 Fon: +49 5231 1429-0
 Fax: +49 5231 14292083
 www.weidmueller.com

Accessories

	block, Orange, No. of poles: 1	
SLA BB2R SW 1723490000	PCB plug-in connector, Accessories, Mounting block, Black, No. of poles: 1	4008190366049 20 pc(s).
SLA BB5R SW 1723510000	PCB plug-in connector, Accessories, Mounting block, Black, No. of poles: 1	4008190366063 20 pc(s).
SLA BB12R 1593450000 OR	PCB plug-in connector, Accessories, Mounting block, Orange, No. of poles: 1	4008190122164 100 pc(s).

Coding elements



Only connects what is supposed to be connected: the right connection at the right place.

Coding elements and locking devices clearly assign connecting elements during the manufacturing process and operation

The coding elements and locking devices are inserted prior to assembly or during the cable assembly phase. The Weidmüller alternative: configure online using the variant configurator to precode prior to delivery.

Incorrect assembly on the circuit board and incorrect plugging of connecting elements is no longer possible. The advantage: no troubleshooting during manufacture and no operational errors by the user.

General ordering data

Type	Order No.	Version	GTIN (EAN)	Qty.	Product data
BLZ/SL KO BK BX	1545710000	PCB plug-in connector, Accessories, Coding element, Black, No. of poles: 1	4008190087142 50 pc(s).		
BLZ/SL KO OR BX	1573010000	PCB plug-in connector, Accessories, Coding element, Orange, No. of poles: 1	4008190048396 100 pc(s).		

OMNIMATE Signal - series BL/SL 5.08 SLD 5.08V/22/90B 3.2 SN OR BX

Weidmüller Interface GmbH & Co. KG
 Klingenbergstraße 16
 D-32758 Detmold
 Germany
 Fon: +49 5231 1429-0
 Fax: +49 5231 14292083
 www.weidmueller.com

Accessories

Additional accessories



No task is too small when creating the perfect solution.

Connections form just one part of the overall process. Small details are often the key to the perfect solution in applications where potentials are tested, grouped or even isolated.

A system is not a system without small but useful details:

- Test plugs - ensure reliable pick-up from diagnostic sockets
- Cross-connectors - ensure a stable electrical distribution contact directly at the connection
- Compartment partition elements - divide a large number of male connectors into several separate socket connector channels
- Locks and clips - optional vibration-resistant clip-on connection or mounting for male and female connectors

In tandem with the manufacturing process and application - more accessories = smaller workload

General ordering data

Type	Order No.	Version	GTIN (EAN)	Qty.	Product data
SL AT SW	1770240000	PCB plug-in connector, Accessories, Partition element, Black, No. of poles: 1	4032248117710	100 pc(s).	
SL AT OR	1598300000	PCB plug-in connector, Accessories, Partition element, Orange, No. of poles: 1	4008190189266	100 pc(s).	

Recommended wave soldering profiles

Weidmüller Interface GmbH & Co. KG
 Klingenbergstraße 16
 D-32758 Detmold
 Germany
 Fon: +49 5231 14-0
 Fax: +49 5231 14-292083
 www.weidmueller.com

Single Wave:

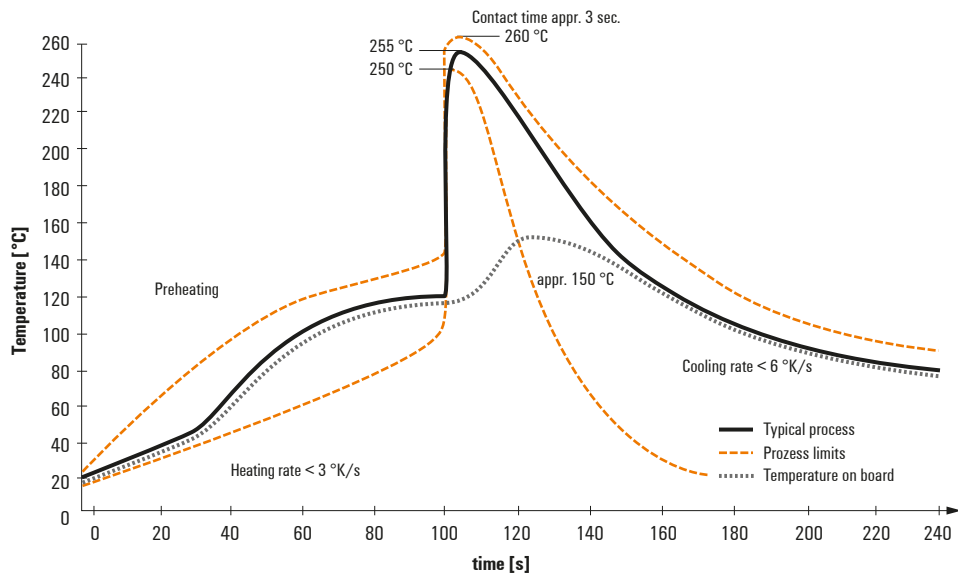

Double Wave:

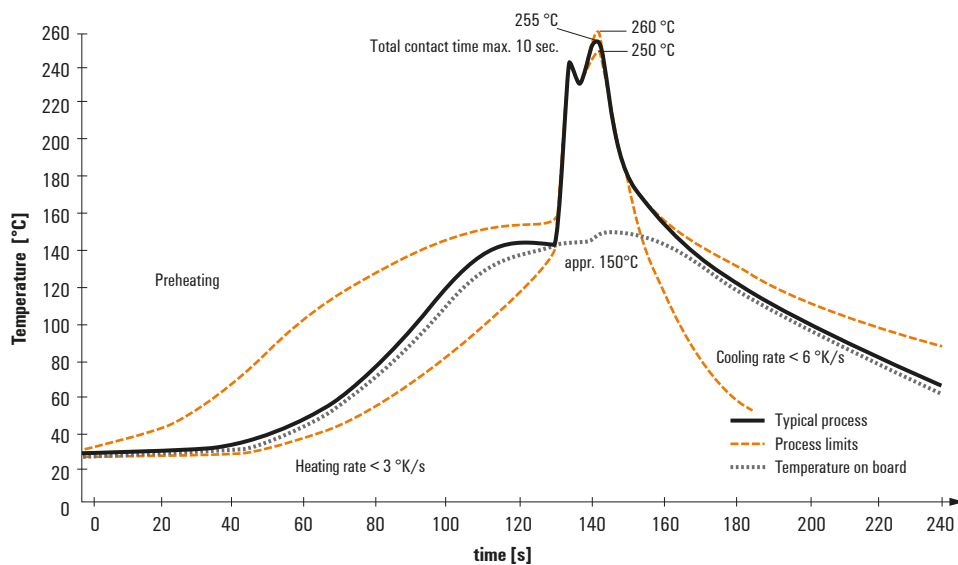

Wave soldering profiles

Wired connection elements should be processed in accordance with the DIN EN 61760-1 standard. We have included two recommendations for practical wave soldering profiles, with which Weidmüller PCB terminals and connectors are qualified.

When choosing a suitable profile for your application, the following factors also need to be considered:

- PCB thickness
- Proportion of Cu in the layers
- Single/double-sided assembly
- Product range
- Heating and cooling rates

The single and double wave profiles each indicate the recommended operating range, including the maximum soldering temperature of 260°C. In practice, the maximum soldering temperature is quite often well below the above maximum profile.

Addresses worldwide

Let's connect.

- AE United Arab Emirates**
Weidmüller Middle East FZE
Warehouse Q3-79
SAIF-Zone
P.O. BOX 8591
Sharjah
Telephone number +971 65572723
Fax number +971 65572724
wme.info@weidmueller.com
- AO Angola**
Please contact
Phambili Interface
South Africa
- AR Argentina**
CPI SA
Bauness 2660
C1431DOF Buenos Aires
Telephone number +54 11 4523 8008
Fax number +54 11 4522 0546
info@cpi.com.ar
www.cpi.com.ar
- AT Austria**
Weidmüller GmbH
IZ NOE Süd, Str 2b, Obj M59,
2355 Wiener Neudorf
Telephone number +43 2236 67080
Fax number +43 2236 6708-899
office.at@weidmueller.com
www.weidmueller.com
- AU Australia**
Weidmüller Pty. Ltd.
PO BOX 6944
Huntingwood 2148
Huntingwood Drive 43
Huntingwood NSW 2148
Telephone number +61 2 9671 9999
Fax number +61 2 9671 9911
info@weidmuller.com.au
www.weidmuller.com.au
- AZ Azerbaijan**
Representative Office
Weidmüller Interface
Demirchi Tower, 4th floor
37, Khojali ave.
AZ 1025 Baku
Telephone number +994 12 488 80 36
Fax number +994 12 488 80 37
aliyar.hashimli@weidmueller
- BA Bosnia and Herzegovina**
Please contact
our Representative Office
Weidmüller Interface GmbH
& Co. KG
Serbia
or
BIG electric d.o.o
Mladena Stojanovića 117A
78000 Banja Luka
Telephone number +387 51926277
Fax number +387 51926277
bigelectric@blic.net
www.bigelectric.ba
- BE Belgium**
Weidmüller Benelux B. V.
Mechelsesteenweg 519 bus
6 en 7
1930 Nossegem
Telephone number +32 2 752 40 70
Fax number +32 2 751 36 06
info@weidmueller.be
www.weidmueller.be
- BG Bulgaria**
Weid-Bul EOOD
Bul. "Kliment Ohridski" 13
1756 Sofia
Telephone number +359 2 963 2560
Fax number +359 2 963 1098
sofia@weidbul.com
www.weidbul.com
- BH Bahrain**
Khayber Trading Company
P.O Box 1976
Manama
Telephone number +973 720747
Fax number +973 720331
khayber@batelco.com.bh
- BR Brazil**
Weidmüller Conexel do Brasil
Conexões Elétricas Ltda.
Av. Presidente Juscelino, 642
- Piraporinha
Diadema, São Paulo
09950-370
Telephone number +55 (11) 4366-9600
Fax number +55 (11) 4362-1677
vendas@weidmueller.com.br
www.weidmueller.com.br
- BW Botswana**
Please contact
Phambili Interface
South Africa
- BY Belarus**
TECHNIKON Ltd.
Nezavisimosti pr. 177-9
220125 Minsk
Telephone number +375 17 393-11-77
Fax number +375 17 3930080
wm@technikon.by
- CA Canada**
W Interconnections Canada
Inc.
10 Spy Court
Markham Ontario L3R 5H6
Telephone number +1 (905) 475-1507 Ext. 9836
Fax number +1 (905) 475-2798
support@weidmuller.ca
www.weidmuller.ca
- CG Congo**
Please contact
Phambili Interface
South Africa
- CH Switzerland**
Weidmüller Schweiz AG
Rundbuckstraße 2
8212 Neuhausen am
Rheinfall SH
Telephone number +41 52 674 07 07
Fax number +41 52 674 07 08
info@weidmueller.ch
www.weidmueller.ch
- CL Chile**
ATS - INTECH
María Luisa Santander 0475
Santiago
Providencia 7500859
Telephone number +56 2 341 1271
Fax number +56 2 341 1275
felipe@atsintech.com
www.atsintech.com
CPI CHILE LTDA
Av. Presidente Frei Montalva
6001, 47 complejo el cortijo
Santiago - Conchalí
Telephone number +562 963 8440
Fax number +562 963 8440
cpi@cpichile.cl
www.cpicchile.cl
- CN China**
Weidmüller Interface
(Shanghai) Co. Ltd.
100 Yutong Road
25 F, BM Intercontinental
Business Center
200070 Shanghai
Telephone number +86 21-22195008
Fax number +86 21-22195009
customer.hotline@weidmueller.com.cn
www.weidmueller.com.cn
- CO Colombia**
Automatización Avanzada
S. A.
Carrera 97 No., 24 c - 23
Bodega 4
110911 Bogotá-D.C.
Telephone number +57 (1) 547-8510
Fax number +57 (1) 422-3044
comercial@automatizacionavanzada.com
www.automatizacionavanzada.com
- CR Costa Rica**
ELVATRON S. A.
la Uruca 400 Norte Banco
Costa Rica
San Jose Costa Rica
Telephone number +506 2961-060
Fax number +506 5200-609
dirk.haase@elvatron.com
www.elvatron.com
- CZ Czech Republic**
Weidmüller s.r.o.
Lomnického 5/1705
140 00 Praha 4
Telephone number +420 244 001 400
Fax number +420 244 001 499
office@weidmueller.cz
www.weidmueller.cz
- DE Germany**
Weidmüller GmbH & Co. KG
Ohmstraße 9
32758 Detmold
Postfach 30 54
32720 Detmold
Telephone number +49 5231 1428-0
Fax number +49 5231 14-292083
weidmuller@weidmueller.de
www.weidmueller.de
- DK Denmark**
Weidmüller Danmark
Vallensbækvej 18A
2605 Brøndby
Telephone number +45 27747800
kundeservice@weidmuller.dk
www.weidmuller.dk
- DZ Algeria**
SARL INTER ELECTRIC
1a Angles des Rues Okba Ibn
Nafaa et Hassi Beida
2300 Annaba
Telephone number
Fax number
contact@inter-electric.com
- EC Ecuador**
Elsystec S. A., Electricidad
Sistemas y Tecnología
Vasco de Contreras N35-251
y Manosca
Quito - Pichincha
Telephone number +593 22456510
Fax number +593 22456755
Elsystec@uio.satnet.net
- EE Estonia**
Please contact
our Representative Office
Weidmüller Interface GmbH
& Co. KG
Latvia
or
Soots Interface OÜ
Pärnu mnt 142
11317 Tallinn
Telephone number +372 609 6933
Fax number
info@sootsinterface.ee
www.sootsinterface.ee
- EG Egypt**
Standard Electric (OMEGA)
1, Abdelhamid Badawy Street
Heliopolis
Cairo
Telephone number +202 21805600
Fax number +202 21805600
stdelec@rite.com
- ES Spain**
Weidmüller, S. A.
Narcís Monturiol 11-13, Pol.
Ind. Sudoeste
8960 Sant Just
Desvern - Barcelona
Telephone number +34 934 803 386
Fax number +34 933 718 055
weidmuller@weidmuller.es
www.weidmuller.es
- FI Finland**
Weidmüller Suomi,
Weidmüller Aktiebolagetin
siivuliike
Koy Plaza Vivace
Äyritie 8C
FI 15100 Vantaa
Telephone number +358 20 7351300
Fax number +358 800 114 667
asiakaspalvelu@weidmuller.fi
www.weidmuller.fi
- FR France**
Weidmüller E. U. R. L.
12, Chaussée Jules César
BP 263 Osny
95523 Cergy-Pontoise Cedex
Telephone number +33 1 34 24 55 00
Fax number +33 1 34 24 55 01
mail@weidmuller.fr
- GB Great Britain**
Weidmüller Ltd.
Klippon House
Centurion Court Office Park,
Meridian East, Meridian
Business Park
Leicester
LE19 1TP
Telephone number +44 116 282 3470
Fax number +44 116 289 3582
marketing@weidmuller.co.uk
www.weidmuller.co.uk
- GE Georgia**
Please contact
our Representative Office
Weidmüller Interface
Azerbaijan.
- GH Ghana**
Please contact
our Representative Office
Weidmüller Interface GmbH
& Co. KG
South Africa.
- GR Greece**
G.A. Solutions
Ippokratous 11 Metamorfosi
144 52 Athen
Telephone number +30 210 2823233
Fax number +30 210 2823233
info@weidmuller.gr
www.weidmuller.gr
- GT Guatemala**
Prestelectro, Prestegard
Electro, S.A.
Avenida Petapa 44-22,
Zona 12
Guatemala City
Telephone number +502 2442-3346
Fax number +502 2476-8945
ventas@prestelectro.com
- HK Hong Kong**
Weidmüller (Hong Kong)
Limited Co. Ltd.
Unit 1617, Metropolis Tower
No. 10 Metropolis Drive,
Hunghom, Kowloon
Telephone number +852 3154 8088
Fax number +852 31548099
Info-hk@weidmueller.com.hk
- HR Croatia**
ElektroPARTNER d.o.o.
Slavonska avenija 24/6
HR-10000 Zagreb
Telephone number +385 (1) 6184 793
Fax number +385 (1) 6184 795
elektropartner@zg.t-com.hr
www.elektropartner.hr
- HU Hungary**
Weidmüller Kereskedelmi Kft.
Budapest
Gubacsi út 6.
1097
Telephone number +36 1 382 7700
Fax number +36 1 382 7701
info@weidmueller.hu
www.weidmueller.hu
- ID Indonesia**
PT. Nego Electrindo
Ruko Mega Grosir Cempaka
Mas Blok I No. 20 – 22
Jakarta 10640
Telephone number +62 21 42882255
Fax number +62 21 42882266
sales@negoelectrindo.co.id
- IE Ireland**
Please contact
Weidmüller Ltd.
Great Britain
- IL Israel**
A. U. Shay Ltd.
23/25, Embarr Street
49222 Petach-Tikva
P.O. Box 1 00 49
49222 Petach-Tikva
Telephone number +972 3-923-3601
Fax number +972 3-923-4601
shay@uriel-shay.com
www.uriel-shay.com
ATEKA Ltd.
4, Ha Tavor lane Industrial
area Segula
49691 Petach-Tikva
P.O. Box 4710
Petach-Tikva
Telephone number +972 73-200-1311
Fax number +972 3-924 4245
marketing@ateka.co.il
www.ateka.co.il
- IN India**
Representative Office
Weidmüller Electronics India
Pvt. Ltd.
No. 9, Union Street, Off.
Infantry Road
BANGALORE
560 001
Telephone number +91-80-22860028
wmi@weidmueller.in
www.weidmueller.com
- IR Iran**
Representative Office
Tamin Ehtiajat Fanni Tehran
(TAF Co.)
Unit #. 5, No. 62 Iranshahr
Ave.
Tehran - 15816-53717, Iran
Telephone number +9821 8831 7851
info@taf-co.com
http://www.taf-co.com
- IS Iceland**
Samey Automation Center
Lyngas 13
210 Garoabaer
Telephone number +354 510 5200
Fax number +354 5 10 5201
Samey@samey.is
www.samey.is
- IT Italy**
Weidmüller S. r.l.
Via Albert Einstein 4
20092 Cinisello
Balsamo Milano
Telephone number +39 02 660681
Fax number +39 02 6124945
weidmuller@weidmuller.it
www.weidmuller.it
- JM Jamaica**
Please contact
W Interconnections Inc.
United States



You can find all Weidmüller addresses and your local contact on the internet at: www.weidmuller.com/countries

Let's connect.

Sales company 

Representation abroad 

without representation abroad 

- JO Jordan**
Trans Jordan for Electro
PO Box 33 06 07
Amman
Telephone number +962 6 533 2020
Fax number +962 6 533 5800
transjordan@batelco.jo
- JP Japan**
Nihon Weidmüller Co. Ltd.
Sphere Tower Tennoz 2-2-8
Higashi-Shinagawa,
Shinagawa-ku
Tokyo
140-0002
Telephone number +81 3 6711 5300
Fax number +81 3 6711 5333
weidmullerjapan@weidmuller.co.jp
www.weidmuller.co.jp
- KE Kenya**
Please contact our Representative Office Weidmüller Interface GmbH & Co. KG South Africa.
- KG Kyrgyzstan**
Please contact our Representative Office Weidmüller Interface Azerbaijan.
- KR Korea**
Weidmuller Korea Co. Ltd.
9th floor
429, Teheran-ro, Gangnam-Gu
Seoul 135-721
Telephone number +82 2-516-0003
Fax number +82 2-516-0090
info@weidmuller.co.kr
www.weidmuller.co.kr
- KW Kuwait**
Kana Controls General Trading & Contracting Co. W. L. L.
Al Rai Industrial Area, Plot 28-30, St. 31
13016 Safat
B.P. 25593
Telephone number +965 4741373
Fax number +965 4741537
info@kanacontrols.com
- KZ Kazakhstan**
Please contact Weidmüller Group Russia
- LB Lebanon**
Progress Engineering & Trading Enterprises
Al Nahr Street
Beirut 11-1111
Telephone number +961 1 444 664
Fax number +961 1 561 880
progress@inco.com.lb
- LT Lithuania**
Please contact our Representative Office Weidmüller Interface GmbH & Co. KG Latvia
or
ELEKTROS IRANGA
Tinklu g. 29 a
LT-5319 Panevezys
Telephone number +370 (45) 582 828
Fax number
info@eliranga.lt
- LU Luxembourg**
Please contact Weidmüller Benelux B. V. Netherlands
- LV Latvia**
SIA Abi4
Daugavgrivas 31b
Riga, LV-1007
Telephone number +371 674 70999
Fax number +371 676 24562
abi_4@tvnet.lv
Representative Office Weidmüller Interface GmbH & Co. KG
Udens str. 12-118
Riga, LV-1007
Telephone number +371 29254766
Fax number +371 674 65637
Ilgonis.rudaks@weidmuller.com
www.weidmuller.com
- MA Morocco**
Sofimed
137, Bd Moulay Ismail Roches Noires
20290 Casablanca
Telephone number
Fax number
contact@sofimedmaroc.com
- MD Moldova**
BERHORD A & D srl
79/1, str. Milescu Spartaru
MD-2075 Chisinau
Moldova
Telephone number +373 (22) 815002
Fax number +373 (22) 815007
atiuleanu@berhord.com
www.ad.berhord.com
- ME Montenegro**
Please contact our Representative Office Weidmüller Interface GmbH & Co. KG Serbia.
- MG Madagascar**
Please contact Phambili Interface South Africa
- MK Macedonia**
Please contact our Representative Office Weidmüller Interface GmbH & Co. KG Serbia
or
ELEKTRO - SMK doool
UL. III Makedonska brigada
b.b.
1000 Skopje
Telephone number +389 22460295
Fax number
Elektro-smk@telelab.net.mk
- MN Mongolia**
Please contact our Representative Office Weidmüller Interface Azerbaijan.
- MT Malta**
E. S. S., Electrical Supplies & Services Ltd.
San Gwakklin Road
Mriehel
Telephone number +356 21255777
Fax number +356 21255999
robert.agius@ess.com.mt
- MU Mauritius**
Mubelo Electrical Ltd.
Office 26, Gateway building,
St Jean Road
Quatre Bornes
Mauritius
Telephone number +230 4670989
Fax number +230 4654051
richard.mubelo@orange.mu
- MW Malawi**
Please contact our Representative Office Weidmüller Interface GmbH & Co. KG South Africa.
- MX Mexico**
W Interconnections S. A.
DE C. V.
Blvd. Hermanos Sardan 698,
Col. San Rafael Oriente
72029 Puebla
Telephone number +52 (222) 268 6227
Fax number +52 (222) 286 6242
clientes@weidmuller.com.mx
- MY Malaysia**
Connect Plus Technology
Sdn Bhd
No. 43, Jalan PJS 11/22,
Bandar Sunway
46150 Petaling Jaya
Selangor Darul Ehsan
Telephone number +60 3 5633 7363
Fax number +60 3 5633 6562
paul@cpstech.com.my
www.cpstech.com.my
- MZ Mozambique**
Please contact Phambili Interface South Africa
- NA Namibia**
Please contact Phambili Interface South Africa
- NG Nigeria**
Please contact Weidmüller Interface GmbH & Co. KG South Africa
- NL Netherlands**
Weidmüller Benelux B. V.
Franciscusweg 221
1216 SE Hilversum
P.O. Box 1505
1200 BM Hilversum
Telephone number +31 35 623 20 44
Fax number +31 35 623 20 44
info@weidmuller.nl
www.weidmuller.nl
- NO Norway**
Sivilingeniør J.F. Knudtzen AS
Billingstadsletta 97
1396 Billingstad
PO Box 160
1378 Nesbru
Telephone number +47 66 98 33 50
Fax number +47 66 98 09 55
firmapost@jfkknudtzen.no
www.jfkknudtzen.no
- NZ New Zealand**
Cuthbert S. Steward Ltd.
27 Te Puni Street
Petone
PO Box 38496
Wellington Mail Centre 5054
Telephone number (04) 568 6156
Fax number (09) 489 1752
csl@cuthbertsteward.co.nz
Cuthbert S. Steward Ltd
4 Fred Thomas Drive
Aon Building, Ground Floor,
South Entry
Takapuna
PO Box 100 338
North Shore City 745
Telephone number (09) 489 1751
Fax number (04) 568 6056
cslak@cuthbertsteward.co.nz
- OM Oman**
DAN INTERNATIONAL LLC.
Ghala St. 111
BP 2901
Seeb
Telephone number +968 5036 77
Fax number +968 5037 55
yedu@danintl.com
- PE Peru**
IMPEXINCA S.A.C.
Calle Ortiz de Zevallos No.
105, Urb. San Antonio
18
Lima, Miraflores
Telephone number +51 1 447 5608
info@impexinca.pe
www.impexinca.pe
J & W CIA, S. A.
Calle 6 Mz. D Lte. 23, Urb.
Ind. Grimanesa
01
Callao
Telephone number +51 1 572 2539
Fax number +51 1 572 0152
contacto@jwcia.com
www.jwcia.com
- PH Philippines**
Enclosure Systems Specialists Inc.
2276 Don Chino Roces
Avenue Extension
Room 103/105 Narra Building
1231 Makati City
Telephone number +63 2 813 8580
Fax number +63 2 813 8596
sales_encsys@pldtdsl.net
www.enclosuresystemsph.com
- PK Pakistan**
Automation Controls (Pak)
Apartment No. 33 C III,
Chenab Block, Allama Iqbal
Town
Lahore
Telephone number +92 42 37809948
Fax number +92 42 37809950
nadeem@acpak.com.pk
www.acpak.com.pk
- PL Poland**
Weidmüller Sp. z. o. o.
ul. Ogrodowa 58
00-876 Warszawa
Telephone number +48 22 510 09 40
Fax number +48 22 510 09 41
biuro@weidmuller.com.pl
www.weidmuller.pl
- PR Puerto Rico**
Please contact W Interconnections Inc. United States
- PT Portugal**
Weidmüller Sistemas de Interface S. A.
Estrada Outeiro Polima, R.
Augusto Dias da Silva, Lote B - Esc. 2
São Domingos de Rana
2785-515 Abóboda
Telephone number +351 214 459 191
Fax number +351 214 455 871
weidmuller@weidmuller.pt
www.weidmuller.pt
- PY Paraguay**
Please contact CPI SA Argentina
- QA Qatar**
Doha Motors
PO Box 145
Telephone number +974 4651441
Fax number +974 4654579
dmtctech@qatar.net.qa
<http://www.dohamotorsgroup.com/td.html>
Petroleum Technology Co. W.L.L.
PO Box 16069
5th Floor Toyota tower
Telephone number +974 44419603
Fax number +974 44419604
petrotec@qatar.net.qa
www.petrotec.com.qa
- RO Romania**
Representative Office Weidmüller Interface GmbH & Co. KG
Ionescu Crum Street, No. 1, 1st Tower, 1st Floor,
Office 4
500446 Brasov - Brasov
Business Park
Telephone number +40 (268) 446 222
Fax number +40 (268) 446 224
claudiu.totea@weidmuller.com
www.weidmuller.ro
- RS Serbia**
Representative Office Weidmüller Interface GmbH & Co. KG
Ustanicka 189, III sprat lokal 7a
11050 Beograd
Telephone number +381 112885274
Fax number +381 112885274
zoran.rabrenovic@weidmuller.com
Tela Elektrik d.o.o.
UI,Dr Drage Ljocić 6
Beograd
Telephone number +381 11 2772 415
Fax number +381 11 2772 850
office@tela.rs
www.tela.rs
- RU Russia**
Weidmüller Group
7/10 Khlebozavodskiy
Passage,
Moskau
115230
Telephone number +7 495 280 72 71
Fax number +7 495 280 72 71
Info@weidmuller.ru
www.weidmuller.ru
- SA Saudi Arabia**
Al Abdulkarim Holding Co.
P.O. Box 4
Dammam 31411
Telephone number +966 3 8337110
Fax number +966 3 8829547
E-mail salehsk@akh.com.sa
www.weidmuller.ae
Saudi Electric Supply Company (SESCO)
P.O. Box 32 98
Al Khobar 31952
Telephone number +966 3 6829546 Ext. 3030
Fax number
E-mail Safdar.Malik@sescogex.com
www.sescogex.com
- SE Sweden**
Weidmüller AB
Axel Danielssons väg 271
BOX 31025
SE-200 49 Malmö
Telephone number +46 77-143 00 44
Fax number +46 40-37 48 60
info@weidmuller.se
www.weidmuller.se
- SG Singapore**
Weidmüller Pte. Ltd.
70 Bendemeer Road
04-03 Luzerne Building
Singapore 339940
Telephone number +65 6841 5311
Fax number +65 6841 5377
info@weidmuller.com.sg
www.weidmuller.com.sg
- SI Slovenia**
Elektrospoji d. o. o.
Stegne 27
SI- 1000 Ljubljana
Osrednjeslovenska
Telephone number +386 1 511 3810
Fax number +386 1 511 1604
info@elektrospoji.si
www.elektrospoji.si

Addresses worldwide

Let's connect.

SK Slovakia
ELEKTRIS s.r.o.
Elektrárenská 1
831 04 Bratislava
Telephone number +421
2/4920 0113
Fax number +421 2/4920
0119
bratislava@elektris.sk

SV El Salvador
Prestegard Electro
11 Avenida Norte No. 240
Edificio Salazar No. 2
San Salvador
Telephone number +503
2271 1690
Fax number +503 2221
3851
prestegard@navegante.com.sv

SY Syria
Please contact
Weidmüller Middle East FZE
United Arab Emirates

SZ Swaziland
Please contact
Phambili Interface
South Africa

TH Thailand
Pisanu Engineering Co. Ltd.
Kwang Dingaeng, Khet
Dingaeng
800/2 Soi Trakulsuk, Asoke-
dindaeng Road
Dindaeng, Bangkok
10400
Telephone number +66 2
248 2896
Fax number +662 105 6301
ecsales@pisanu.co.th
www.pisanu.co.th

Representative Office
Weidmüller Pte. Ltd.
37/F, Sathorn Square Building
98 North Sathorn Road
Bangkok, Silom Bangrak
10500
Telephone number +66 2
105 6300
Fax number +66 2 642 9220
info@weidmuller.com.sg

TJ Tajikistan
Please contact
our Representative Office
Weidmüller Interface
Azerbaijan.

TM Turkmenistan
Please contact
our Representative Office
Weidmüller Interface
Azerbaijan.

TN Tunisia
Please contact
Weidmüller E. U. R. L.
France

TR Turkey
Weidmüller Elektronik Ticaret
Ltd. Sirketi
Kavacik Mah. Orhan Veli Kanik
Caddesi 9/1
34810 Beykoz / Istanbul
Telephone number +90 (216)
537 10 70
Fax number +90 (216) 537
10 77
info@weidmuller.com.tr
www.weidmuller.com.tr

TW Taiwan
Please contact
Weidmüller (Hong Kong)
Limited Co. Ltd.
Hong Kong

TZ Tanzania
Please contact
our Representative Office
Weidmüller Interface GmbH
& Co. KG
South Africa.

UA Ukraine
LLC WM UKRAINE
Levanevskogo str. 6
Kiev
3058
Telephone number +38 044
490 32 48
Fax number
info@wm-ua.com.ua
wm-ua.com.ua/

Representative Office
Weidmüller Interface GmbH
& Co. KG
Z. office 303
7-D, Zdolbunivska str.
Kiev, 2081
Telephone number
(mobile) +38 050 440 25 24
info.ua@weidmueller.com

US United States
W Interconnections Inc.
821 Southlake Boulevard
Richmond Virginia 23236
Telephone number +1 (804)
794-2877
Fax number +1 (804) 379-
2593
info@weidmuller.com
www.weidmuller.com

UY Uruguay
REWU Uruguay S. A.
AV. Bolivia 2001Esq
Rocafuerte
11300 Carrasco Montevideo
Telephone number +598
2604 8439
Fax number +598 2604
8439
rewo@rewoouruguay.com.uy

UZ Republic of Uzbekistan
Please contact
our Representative Office
Weidmüller Interface
Azerbaijan.

VE Venezuela
Somerinca C. A.
Corazon de Jesus - 3ra
Transversal con calle el
Carmen- Los Dos Caminos
Caracas 1070-A
Telephone number +58
2122352748
Fax number +58
2122399341
klocmoeller@cantv.net
www.somerinca.com

VN Vietnam
ALUMI Industrial Equipment &
Automation Company Limited
E1, La Thanh Hotel
218 Doi Can Street
Lieu Giai Ward, Ba Dinh
District
Hanoi City
Telephone number +84 4
37628601
Fax number +84 4
62661391
aumi@aumi.com.vn
www.aumi.com.vn

Representative Office
Weidmüller Pte. Ltd.
Level 16 Saigon Tower
Building
29 Le Duan Street
District 1
Ho Chi Minh
Telephone number +848
3520 7717
Fax number +848 3520
7604
info@weidmuller.com.sg

ZA South Africa
Phambili Interface
PO Box 193
1609 Johannesburg, Edenvale
5 Bundo Road, Sebenza
1610 Johannesburg
Telephone number +27 (11)
4521930
Fax number
info@weidmuller.co.za
www.weidmuller.co.za

Representative Office
Weidmüller Interface GmbH
& Co. KG
210 Amarand
Avenue, Pegasus Building
181 Pretoria, waterkloof Glen
ext 2 -
Telephone number +27 12
003 2906
Fax number +27 (11)
4526455
Jacques.Vosloo@weidmueller.
com
www.weidmueller.com

ZM Zambia
Please contact
Phambili Interface
South Africa

ZW Zimbabwe
Please contact
Phambili Interface
South Africa