

**FC/FFP ZE/12 B BX****Weidmüller Interface GmbH & Co. KG**

Klingenbergstraße 26

D-32758 Detmold

Germany

www.weidmueller.com

**OMNIMATE® - Board-to-Board connectors**

Flexible engineering of compact devices

The use of future-proof contact systems, as well as the optimisation of manufacturing processes, are increasingly important in the development of efficient industrial devices, especially in the field of Industry 4.0.

OMNIMATE® board-to-board connectors feature a 1.27 mm pitch and offer maximum flexibility due to different designs.

- **Flexible device design** - Industrial suitable density combined with high flexible connection combinations (Mezzanine, Mother-to-Daughter, Extender-card, Cable-to-Board)
- **Automation-Ready** - Developed for automatic assembly with high precise pin coplanarity and SMT-fixation
- **Reliable contact** - Up to 500 mating cycles due to industry suitable gold-surface (PdNi-Au)
- **Process-Ready** - High performance LCP material for reflow soldering
- **Scalability** - Different heights with high contact overlapping ensure various solutions from 12 – 80 poles.
- **Robust miniaturisation** - simple and safe connection even possible under unfavorable mating conditions – e.g. inclination or offset.

**General ordering data**

Version	PCB plug-in connector, Accessories, Pitch in mm (P): 1.27 mm, Number of poles: 12, Box
Order No.	<a href="#">2852980000</a>
Type	FC/FFP ZE/12 B BX
GTIN (EAN)	4064675475316
Qty.	100 pc(s).
Product data	UL:
Packaging	Box

## FC/FFP ZE/12 B BX

**Weidmüller Interface GmbH & Co. KG**

Klingenbergstraße 26

D-32758 Detmold

Germany

www.weidmueller.com

## Technical data

### Dimensions and weights

Depth	6.3 mm	Depth (inches)	0.248 inch
Height	9.9 mm	Height (inches)	0.39 inch
Width	11.12 mm	Width (inches)	0.438 inch
Net weight	0.22 g		

### Material data

Insulating material	LCP	Colour	black
Colour chart (similar)	RAL 9011	Moisture Level (MSL)	1
UL 94 flammability rating	V-0	Storage temperature, min.	-40 °C
Storage temperature, max.	70 °C	Operating temperature, min.	-55 °C
Operating temperature, max.	125 °C		

### Packing

Packaging	Box	VPE length	173 mm
VPE width	102 mm	VPE height	43 mm

### Classifications

ETIM 6.0	EC002943	ETIM 7.0	EC002943
ETIM 8.0	EC002943	ETIM 9.0	EC002943
ECLASS 9.0	27-44-04-92	ECLASS 9.1	27-44-04-92
ECLASS 10.0	27-44-04-92	ECLASS 11.0	27-46-04-02
ECLASS 12.0	27-46-04-02	ECLASS 13.0	27460402

### Important note

IPC conformity	Conformity: The products are developed, manufactured and delivered according international recognized standards and norms and comply with the assured properties in the data sheet resp. fulfill decorative properties in accordance with IPC-A-610 "Class 2". Further claims on the products can be evaluated on request.
----------------	--

### Approvals

ROHS	Conform
------	---------

### Downloads

Engineering Data	<a href="#">CAD data – STEP</a>
Catalogues	<a href="#">Catalogues in PDF-format</a>

**FC/FFP ZE/12 B BX**

**Weidmüller Interface GmbH & Co. KG**  
Klingenbergstraße 26  
D-32758 Detmold  
Germany

[www.weidmueller.com](http://www.weidmueller.com)

**Drawings**

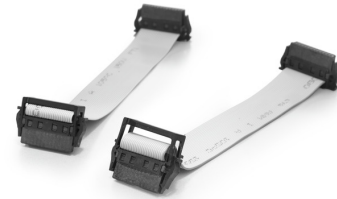
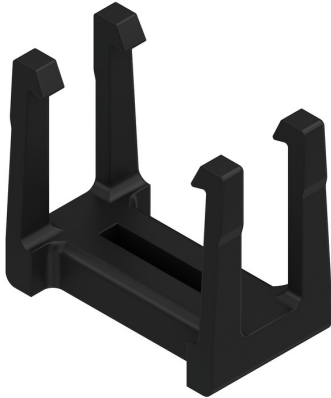

With optional strain relief

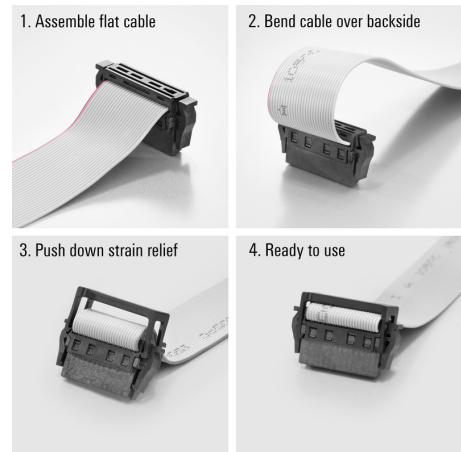
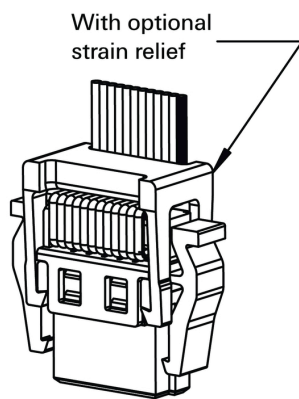

Assembly of strain relief

## FC/FFP ZE/.. B BX

### Female plug (FFP) with strain relief

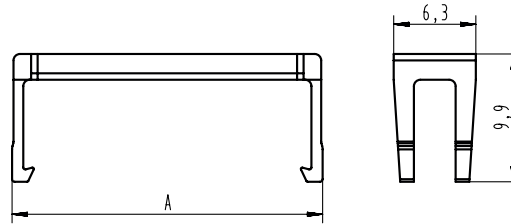
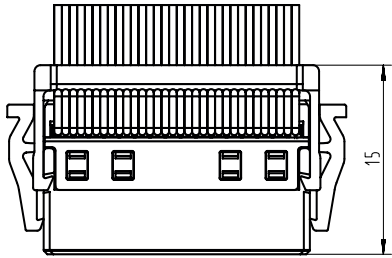

Type	Order no.	No. of poles	A
FC/FFP ZE/12 B BX	2852980000	12	11.12
FC/FFP ZE/16 B BX	2852990000	16	13.66
FC/FFP ZE/20 B BX	2853000000	20	16.20
FC/FFP ZE/26 B BX	2853120000	26	20.01
FC/FFP ZE/32 B BX	2853130000	32	23.82
FC/FFP ZE/40 B BX	2853140000	40	28.90
FC/FFP ZE/50 B BX	2853150000	50	35.25

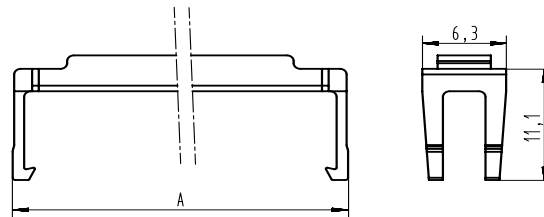
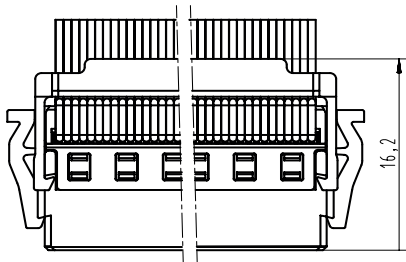

Type	Order no.	No. of poles	A
FC/FFP ZE/68 B BX	2853160000	68	46.68
FC/FFP ZE/80 B BX	2853190000	80	54.30

### Before harnessing

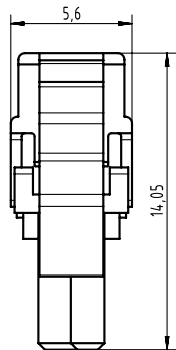

### After harnessing

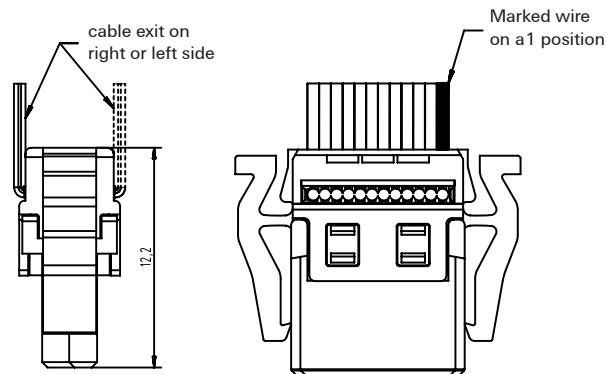

### With and without strain relief

