

BUF 10.16IT/03/180MF2 AG BK BX

Weidmüller Interface GmbH & Co. KG
 Klingenbergstraße 26
 D-32758 Detmold
 Germany

www.weidmueller.com

Product image

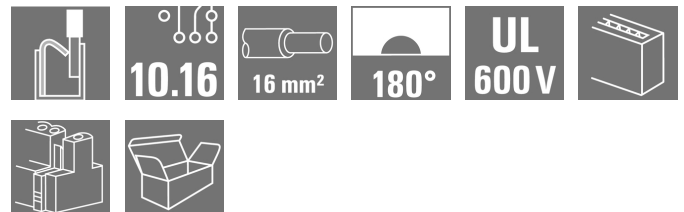

Device connectivity | OMNIMATE® Power BUF 10.16
 PUSH IN PCB connector, 16mm², with wire-ready
 function

- PUSH IN technology with settable wire-ready contact point simplifies the connection of stranded wires without wire-end ferrules and wires with particularly rigid insulation
- Direct and tool-free connection of solid wires and wires with crimped wire-end ferrules for fast and safe wiring
- Single-hand operation of the plug-in connector and automatic connection thanks to the middle flange with snap-on mechanism and optionally with additional screw fastening

General ordering data

Version	PCB plug-in connector, female plug, 10.16 mm, Number of poles: 3, 180°, PUSH IN with actuator, Clamping range, max. : 16 mm ² , Box
Order No.	2493 180000
Type	BUF 10.16IT/03/180MF2 AG BK BX
GTIN (EAN)	4050118502763
Qty.	28 pc(s).
Product data	IEC: 1000 V / 76 A / 2.5 - 16 mm ² UL: 600 V / 51 A / AWG 12 - AWG 6
Packaging	Box

Creation date December 4, 2023 1:37:46 PM CET

BUF 10.16IT/03/180MF2 AG BK BX**Weidmüller Interface GmbH & Co. KG**

Klingenbergstraße 26

D-32758 Detmold

Germany

www.weidmueller.com

Technical data**Dimensions and weights**

Depth	39.5 mm	Depth (inches)	1.555 inch
Height	33.3 mm	Height (inches)	1.311 inch
Width	40.64 mm	Width (inches)	1.6 inch
Net weight	42.62 g		

System Parameters

Product family	OMNIMATE Power - series BU/SU 10.16	Type of connection	Field connection
Wire connection method	PUSH IN with actuator	Pitch in mm (P)	10.16 mm
Pitch in inches (P)	0.4 inch	Conductor outlet direction	180°
Number of poles	3	L1 in mm	30.48 mm
L1 in inches	1.2 inch	Number of rows	1
Pin series quantity	1	Rated cross-section	16 mm ²
Touch-safe protection acc. to DIN VDE 57 106	Safe from finger touch	Touch-safe protection acc. to DIN VDE 0470	IP 20
Protection degree	IP20	Can be coded	Yes
Stripping length	18 mm	Screwdriver blade	0.8 x 4.0
Screwdriver blade standard	DIN 5264	Plugging cycles	25
Plugging force/pole, max.	15 N	Pulling force/pole, max.	15 N

Material data

Insulating material	PA GF	Colour	black
Colour chart (similar)	RAL 9011	Insulating material group	II
Comparative Tracking Index (CTI)	≥ 400	Insulation strength	≥ 10 ⁸ Ω
UL 94 flammability rating	V-0	Contact material	Cu-alloy
Contact surface	silver-plated	Layer structure of plug contact	≥ 3 μm Ag
Storage temperature, min.	-40 °C	Storage temperature, max.	70 °C
Operating temperature, min.	-50 °C	Operating temperature, max.	120 °C

Conductors suitable for connection

Clamping range, min.	2.5 mm ²
Clamping range, max.	16 mm ²
Wire connection cross section AWG, min.	AWG 12
Wire connection cross section AWG, max.	AWG 4
Solid, min. H05(07) V-U	2.5 mm ²
Solid, max. H05(07) V-U	10 mm ²
Stranded, min. H07V-R	10 mm ²
Stranded, max. H07V-R	16 mm ²
Flexible, min. H05(07) V-K	2.5 mm ²
Flexible, max. H05(07) V-K	16 mm ²
w. plastic collar ferrule, DIN 46228 pt 4, 2.5 mm ² min.	
w. plastic collar ferrule, DIN 46228 pt 4, 16 mm ² max.	
w. wire end ferrule, DIN 46228 pt 1, 2.5 mm ² min.	
w. wire end ferrule, DIN 46228 pt 1, 16 mm ² max.	

Creation date December 4, 2023 1:37:46 PM CET

Catalogue status 24.11.2023 / We reserve the right to make technical changes.

2

BUF 10.16IT/03/180MF2 AG BK BX

Weidmüller Interface GmbH & Co. KG
 Klingenbergstraße 26
 D-32758 Detmold
 Germany

www.weidmueller.com

Technical data

Clampable conductor	Cross-section for conductor connection	Type	fine-wired	
		nominal	2.5 mm ²	
	wire end ferrule	Stripping length	nominal	20 mm
		Recommended wire-end ferrule	H2.5/25D BL	
		Stripping length	nominal	18 mm
		Recommended wire-end ferrule	H2.5/18	
	Cross-section for conductor connection	Type	fine-wired	
		nominal	4 mm ²	
	wire end ferrule	Stripping length	nominal	20 mm
		Recommended wire-end ferrule	H4.0/26D GR	
		Stripping length	nominal	18 mm
		Recommended wire-end ferrule	H4.0/18	
	Cross-section for conductor connection	Type	fine-wired	
		nominal	6 mm ²	
	wire end ferrule	Stripping length	nominal	20 mm
		Recommended wire-end ferrule	H6.0/26 SW	
		Stripping length	nominal	18 mm
		Recommended wire-end ferrule	H6.0/18	
	Cross-section for conductor connection	Type	fine-wired	
		nominal	10 mm ²	
	wire end ferrule	Stripping length	nominal	21 mm
		Recommended wire-end ferrule	H10.0/28 EB	
		Stripping length	nominal	18 mm
		Recommended wire-end ferrule	H10.0/18	
Cross-section for conductor connection	Type	fine-wired		
	nominal	16 mm ²		
wire end ferrule	Stripping length	nominal	21 mm	
	Recommended wire-end ferrule	H16.0/28 GN		
	Stripping length	nominal	18 mm	
	Recommended wire-end ferrule	H16.0/18		

Reference text Length of ferrules is to be chosen depending on the product and the rated voltage.

Rated data acc. to IEC

Rated current, min. number of poles (Tu=20°C)	76 A	Rated current, max. number of poles (Tu=20°C)	71 A
Rated current, min. number of poles (Tu=40°C)	70 A	Rated current, max. number of poles (Tu=40°C)	62 A
Rated voltage for surge voltage class / pollution degree II/2	1,000 V	Rated voltage for surge voltage class / pollution degree III/2	1,000 V
Rated voltage for surge voltage class / pollution degree III/3	1,000 V	Rated impulse voltage for surge voltage class/ pollution degree II/2	8 kV
Rated impulse voltage for surge voltage class/ pollution degree III/2	8 kV	Rated impulse voltage for surge voltage class/ contamination degree III/3	8 kV
Short-time withstand current resistance	3 x 1s with 800A		

BUF 10.16IT/03/180MF2 AG BK BX

Weidmüller Interface GmbH & Co. KG
 Klingenbergstraße 26
 D-32758 Detmold
 Germany

www.weidmueller.com

Technical data

Rated data acc. to UL 1059

Institute (cURus)



Certificate No. (cURus)

E60693

Rated voltage (Use group B / UL 1059)	600 V	Rated voltage (Use group C / UL 1059)	600 V
Rated current (Use group B / UL 1059)	51 A	Rated current (Use group C / UL 1059)	51 A
Wire cross-section, AWG, min.	AWG 12	Wire cross-section, AWG, max.	AWG 6
Reference to approval values	Specifications are maximum values, details - see approval certificate.		

Packing

Packaging	Box	VPE length	356 mm
VPE width	186 mm	VPE height	76 mm

Type tests

Test: Durability of markings	Standard	IEC 60068-2-70 / 12.95		
	Test	mark of origin, type identification, pitch, durability		
	Evaluation	available		
Test: Clampable cross section	Standard	IEC 60999-1:1999-11 section 9.1, IEC 60947-1:2011-03 section 8.2.4.5.1		
	Conductor type	Type of conductor and conductor cross-section	stranded 2.5 mm ²	
		Type of conductor and conductor cross-section	solid 2.5 mm ²	
		Type of conductor and conductor cross-section	stranded 16 mm ²	
		Type of conductor and conductor cross-section	solid 10 mm ²	
		Type of conductor and conductor cross-section	AWG 12/1	
		Type of conductor and conductor cross-section	AWG 12/19	
	Evaluation	passed		

BUF 10.16IT/03/180MF2 AG BK BX

Weidmüller Interface GmbH & Co. KG
 Klingenbergstraße 26
 D-32758 Detmold
 Germany

www.weidmueller.com

Technical data

Test for damage to and accidental loosening of conductors	Standard	IEC 60999-1:1999-11 section 9.4 bzw. section 8.10		
	Requirement	0.7 kg		
	Conductor type	Type of conductor and conductor cross-section	H07V-K2.5	
		Type of conductor and conductor cross-section	H07V-U2.5	
		Type of conductor and conductor cross-section	AWG 14/1	
		Type of conductor and conductor cross-section	AWG 14/19	
	Evaluation	passed		
	Requirement	2.9 kg		
	Conductor type	Type of conductor and conductor cross-section	H07V-K16	
		Type of conductor and conductor cross-section	H07V-U16	
Evaluation	passed			
Pull-out test	Standard	IEC 60999-1:1999-11 section 9.5		
	Requirement	≥50 N		
	Conductor type	Type of conductor and conductor cross-section	AWG 14/1	
		Type of conductor and conductor cross-section	AWG 14/19	
		Type of conductor and conductor cross-section	H07V-K2.5	
		Type of conductor and conductor cross-section	H07V-U2.5	
	Evaluation	passed		
	Requirement	≥100 N		
	Conductor type	Type of conductor and conductor cross-section	H07V-K16	
		Type of conductor and conductor cross-section	H07V-U16	
Evaluation	passed			

Classifications

ETIM 6.0	EC002638	ETIM 7.0	EC002638
ETIM 8.0	EC002638	ETIM 9.0	EC002638
ECLASS 9.0	27-44-03-09	ECLASS 9.1	27-44-03-09
ECLASS 10.0	27-44-03-09	ECLASS 11.0	27-46-02-02
ECLASS 12.0	27-46-02-02	ECLASS 13.0	27460202

BUF 10.16IT/03/180MF2 AG BK BX

Weidmüller Interface GmbH & Co. KG
 Klingenbergstraße 26
 D-32758 Detmold
 Germany

www.weidmueller.com

Technical data
Important note

IPC conformity	Conformity: The products are developed, manufactured and delivered according international recognized standards and norms and comply with the assured properties in the data sheet resp. fulfill decorative properties in accordance with IPC-A-610 "Class 2". Further claims on the products can be evaluated on request.
Notes	<ul style="list-style-type: none"> • Additional variants on request • Rated current related to rated cross-section & min. No. of poles. • Wire end ferrule with plastic collar to DIN 46228/4 • Wire end ferrule without plastic collar to DIN 46228/1 • P on drawing = pitch • Rated data refer only to the component itself. Clearance and creepage distances to other components are to be designed in accordance with the relevant application standards. • For all applications with flange we recommend to fix the pin header with the help of the soldering flange or a self-tapping screw on the board. • In accordance with IEC 61984, OMNIMATE-connectors are connectors without breaking capacity (COC). During designated use, connectors are not allowed to be engaged or disengaged when live or under load • Long term storage of the product with average temperature of 50 °C and maximum humidity 70%, 36 months

Approvals

Approvals



UL File Number Search	UL Website
Certificate No. (cURus)	E60693

Downloads

Approval/Certificate/Document of Conformity	Declaration of the Manufacturer
Engineering Data	CAD data – STEP
Product Change Notification	20220208 Visual change Temporarily different color for connectors and accessories 20220208 Visuelle Änderung Vorübergehend anderer Farbton für Steckverbinder und Zubehör
User Documentation	Assembly instructions PUSH IN connector with actuator – BUF 10.16 IT QR-Code product handling video
Catalogues	Catalogues in PDF-format

BUF 10.16IT/03/180MF2 AG BK BX

Weidmüller Interface GmbH & Co. KG
 Klängenbergstraße 26
 D-32758 Detmold
 Germany

www.weidmueller.com

Drawings

Product image

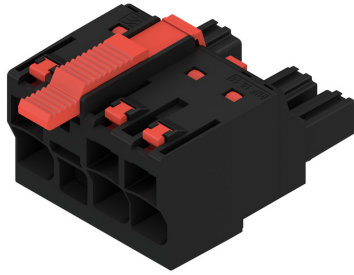

Dimensional drawing

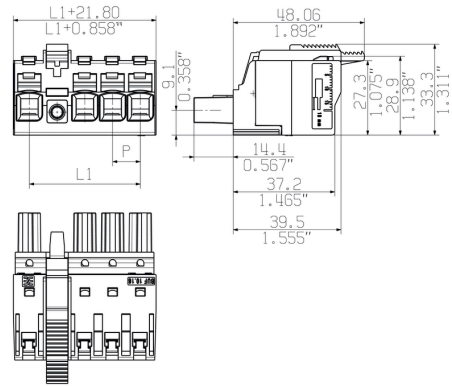

Similar to illustration

Connection diagram

4	M(S)F4	o	o	o	X	o
4	M(S)F3	o	o	X	o	o
4	M(S)F2	o	X	o	o	o
3	M(S)F3	o	o	X	o	
3	M(S)F2	o	X	o	o	
2	M(S)F2	o	X	o		
NO OF POLES	X = MIDDLE FLANGE POSITION	POS. 1 2 3 4 5				

Graph

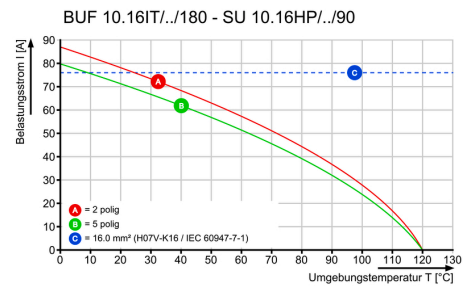

Graph

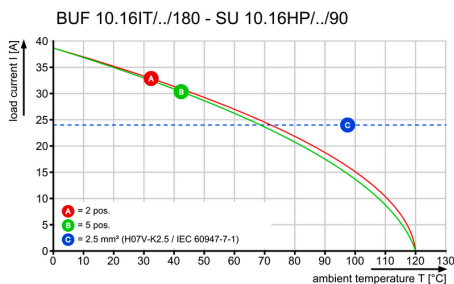

Product benefits

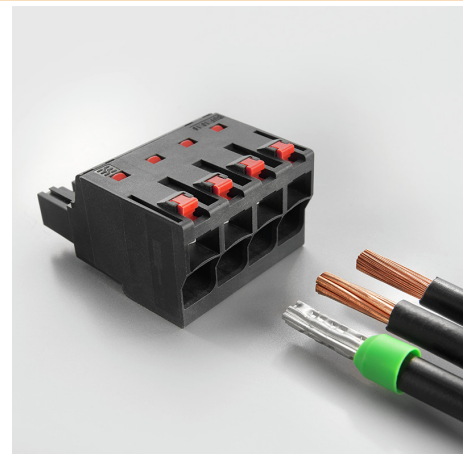

Easy connection of conductors
WIRE READY

Easy connection of conductors
WIRE READY

BUF 10.16IT/03/180MF2 AG BK BX

Weidmüller Interface GmbH & Co. KG
Klingenbergstraße 26
D-32758 Detmold
Germany

www.weidmueller.com

Drawings

Product benefits



Quick wiring

Product benefits

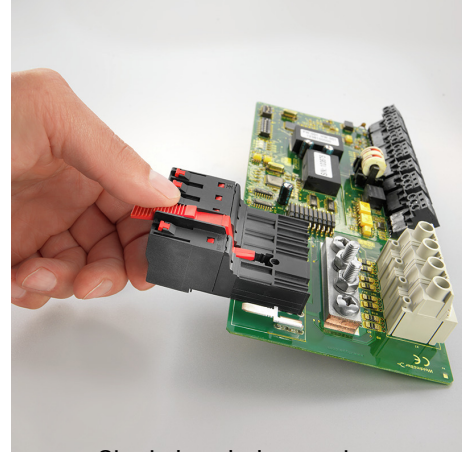

Single-handed operation
Automatic latching