

## LUF 10.00/09/90V 5.0SN BK BX

**Weidmüller Interface GmbH & Co. KG**  
 Klingenbergstraße 26  
 D-32758 Detmold  
 Germany

www.weidmueller.com

### Product image

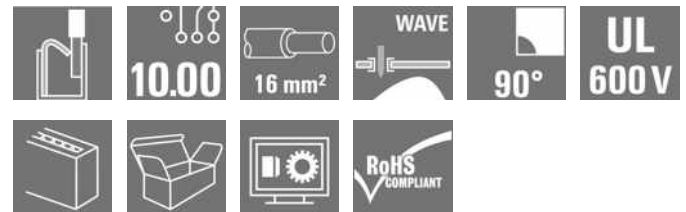

Similar to illustration

High-performance PCB terminal with a PUSH IN connection system for conductor cross-sections up to 16 mm<sup>2</sup>.

- Fast connection without tools thanks to pushers to open the contact point, or direct plug-in method
- Securely closed contact point, with the "Connection Safety Concept" the conductor is always clamped securely
- Integrated test point for PS 2.0 test plug
- Central tip test point for test probes on the upper side of the terminal
- Increased derating reserves because WEMID insulating material is used.
- Conductor outlet direction of 180°

### General ordering data

Version	Printed circuit board terminals, 10.00 mm, Number of poles: 9, 90°, Solder pin length (l): 5 mm, black, PUSH IN with actuator, Clamping range, max. : 16 mm <sup>2</sup> , Box
Order No.	<a href="#">2453760000</a>
Type	LUF 10.00/09/90V 5.0SN BK BX
GTIN (EAN)	4050118493665
Qty.	10 pc(s).
Product data	IEC: 1000 V / 92 A / 0.5 - 25 mm <sup>2</sup> UL: 600 V / 58 A / AWG 18 - AWG 6
Packaging	Box

Creation date February 9, 2023 8:19:32 AM CET

## LUF 10.00/09/90V 5.0SN BK BX

Weidmüller Interface GmbH &amp; Co. KG

Klingenbergstraße 26

D-32758 Detmold

Germany

www.weidmueller.com

## Technical data

## Dimensions and weights

Depth	26.45 mm	Depth (inches)	1.041 inch
Height	47.03 mm	Height (inches)	1.852 inch
Height of lowest version	42.03 mm	Width	91.58 mm
Width (inches)	3.606 inch	Net weight	93.3 g

## Temperatures

Operating temperature, min.	-40 °C	Operating temperature, max.	120 °C
-----------------------------	--------	-----------------------------	--------

## System parameters

Product family	OMNIMATE Power - series LU	Wire connection method	PUSH IN with actuator
Mounting onto the PCB	THT solder connection	Conductor outlet direction	90°
Pitch in mm (P)	10 mm	Pitch in inches (P)	0.394 inch
Number of poles	9	Pin series quantity	1
Fitted by customer	No	Number of rows	1
Solder pin length (l)	5 mm	Solder pin dimensions	d = 1.2 mm, Octagonal
Solder eyelet hole diameter (D)	1.6 mm	Solder eyelet hole diameter tolerance (D)	+ 0, 1 mm
Number of solder pins per pole	2	Screwdriver blade	0.8 x 4.0
Stripping length	18 mm	L1 in mm	80 mm
L1 in inches	3.15 inch	Touch-safe protection acc. to DIN VDE 0470	IP20 plugged/ IP10 unplugged
Touch-safe protection acc. to DIN VDE 57 106	touch-safe with connected connectors from 6 mm <sup>2</sup>	Protection degree	IP20

## Material data

Insulating material	Wemid (PA)	Colour	black
Colour chart (similar)	RAL 9011	Insulating material group	I
Comparative Tracking Index (CTI)	≥ 600	UL 94 flammability rating	V-0
Contact base material	E-Cu	Storage temperature, min.	-40 °C
Storage temperature, max.	70 °C	Operating temperature, min.	-40 °C
Operating temperature, max.	120 °C		

## Conductors suitable for connection

Clamping range, min.	0.5 mm <sup>2</sup>
Clamping range, max.	16 mm <sup>2</sup>
Solid, min. H05(07) V-U	0.5 mm <sup>2</sup>
Solid, max. H05(07) V-U	16 mm <sup>2</sup>
Stranded, min. H07V-R	6 mm <sup>2</sup>
Stranded, max. H07V-R	25 mm <sup>2</sup>
Flexible, min. H05(07) V-K	0.5 mm <sup>2</sup>
Flexible, max. H05(07) V-K	25 mm <sup>2</sup>
w. plastic collar ferrule, DIN 46228 pt 4, min.	0.5 mm <sup>2</sup>
w. plastic collar ferrule, DIN 46228 pt 4, max.	16 mm <sup>2</sup>
w. wire end ferrule, DIN 46228 pt 1, min.	0.5 mm <sup>2</sup>
w. wire end ferrule, DIN 46228 pt 1, max.	16 mm <sup>2</sup>
Plug gauge in accordance with EN 60999 a x b; ø	5.3mm (B6)

Creation date February 9, 2023 8:19:32 AM CET

Catalogue status 03.02.2023 / We reserve the right to make technical changes.

2

**LUF 10.00/09/90V 5.0SN BK BX**

**Weidmüller Interface GmbH & Co. KG**  
 Klingenbergstraße 26  
 D-32758 Detmold  
 Germany

www.weidmueller.com

**Technical data**

Clampable conductor	Cross-section for conductor connection	Type	fine-wired
		nominal	2.5 mm <sup>2</sup>
wire end ferrule		Stripping length	nominal 20 mm
		Recommended wire-end ferrule	<a href="#">H2.5/25D BL</a>
		Stripping length	nominal 18 mm
		Recommended wire-end ferrule	<a href="#">H2.5/18</a>
Cross-section for conductor connection	Type	fine-wired	
	nominal	4 mm <sup>2</sup>	
wire end ferrule		Stripping length	nominal 20 mm
		Recommended wire-end ferrule	<a href="#">H4.0/26D GR</a>
		Stripping length	nominal 18 mm
		Recommended wire-end ferrule	<a href="#">H4.0/18</a>
Cross-section for conductor connection	Type	fine-wired	
	nominal	6 mm <sup>2</sup>	
wire end ferrule		Stripping length	nominal 20 mm
		Recommended wire-end ferrule	<a href="#">H6.0/26 SW</a>
		Stripping length	nominal 18 mm
		Recommended wire-end ferrule	<a href="#">H6.0/18</a>
Cross-section for conductor connection	Type	fine-wired	
	nominal	10 mm <sup>2</sup>	
wire end ferrule		Stripping length	nominal 21 mm
		Recommended wire-end ferrule	<a href="#">H10.0/28 EB</a>
		Stripping length	nominal 18 mm
		Recommended wire-end ferrule	<a href="#">H10.0/18</a>
Cross-section for conductor connection	Type	fine-wired	
	nominal	16 mm <sup>2</sup>	
wire end ferrule		Stripping length	nominal 21 mm
		Recommended wire-end ferrule	<a href="#">H16.0/28 GN</a>
		Stripping length	nominal 18 mm
		Recommended wire-end ferrule	<a href="#">H16.0/18</a>
Cross-section for conductor connection	Type	fine-wired	
	nominal	1.5 mm <sup>2</sup>	
wire end ferrule		Stripping length	nominal 20 mm
		Recommended wire-end ferrule	<a href="#">H1.5/24 R</a>
		Stripping length	nominal 18 mm
		Recommended wire-end ferrule	<a href="#">H1.5/18</a>

Reference text Length of ferrules is to be chosen depending on the product and the rated voltage., The outside diameter of the plastic collar should not be larger than the pitch (P)

## LUF 10.00/09/90V 5.0SN BK BX

Weidmüller Interface GmbH &amp; Co. KG

Klingenbergstraße 26

D-32758 Detmold

Germany

www.weidmueller.com

## Technical data

## Rated data acc. to IEC

tested acc. to standard	IEC 60947-7-4	Rated current, min. number of poles (Tu=20°C)	92 A
Rated current, max. number of poles (Tu=20°C)	80 A	Rated current, min. number of poles (Tu=40°C)	82 A
Rated current, max. number of poles (Tu=40°C)	76 A	Rated voltage for surge voltage class / pollution degree II/2	1,000 V
Rated voltage for surge voltage class / pollution degree III/2	690 V	Rated voltage for surge voltage class / pollution degree III/3	1,000 V
Rated impulse voltage for surge voltage class/ pollution degree II/2	6 kV	Rated impulse voltage for surge voltage class/ pollution degree III/2	6 kV
Rated impulse voltage for surge voltage class/ contamination degree III/3	8 kV		

## Rated data acc. to CSA

Rated voltage (Use group B / CSA)	600 V	Rated voltage (Use group C / CSA)	600 V
Rated voltage (Use group D / CSA)	600 V	Rated current (Use group B / CSA)	58 A
Rated current (Use group C / CSA)	58 A	Rated current (Use group D / CSA)	5 A
Wire cross-section, AWG, min.	AWG 18	Wire cross-section, AWG, max.	AWG 6

## Rated data acc. to UL 1059

Institute (cURus)		Certificate No. (cURus)	E60693
Rated voltage (Use group B / UL 1059)	600 V	Rated voltage (Use group C / UL 1059)	600 V
Rated voltage (Use group D / UL 1059)	600 V	Rated current (Use group B / UL 1059)	58 A
Rated current (Use group C / UL 1059)	58 A	Rated current (Use group D / UL 1059)	5 A
Wire cross-section, AWG, min.	AWG 18	Wire cross-section, AWG, max.	AWG 6
Reference to approval values	Specifications are maximum values, details - see approval certificate.		

## Packing

Packaging	Box	VPE length	330 mm
VPE width	96 mm	VPE height	54 mm

## Classifications

ETIM 6.0	EC002643	ETIM 7.0	EC002643
ETIM 8.0	EC002643	ECLASS 9.0	27-44-04-01
ECLASS 9.1	27-44-04-01	ECLASS 10.0	27-44-04-01
ECLASS 11.0	27-46-01-01	ECLASS 12.0	27-46-01-01

## LUF 10.00/09/90V 5.0SN BK BX

Weidmüller Interface GmbH &amp; Co. KG

Klingenbergstraße 26

D-32758 Detmold

Germany

www.weidmueller.com

## Technical data

## Important note

IPC conformity	Conformity: The products are developed, manufactured and delivered according international recognized standards and norms and comply with the assured properties in the data sheet resp. fulfill decorative properties in accordance with IPC-A-610 "Class 2". Further claims on the products can be evaluated on request.
Notes	<ul style="list-style-type: none"> <li>• Additional variants on request</li> <li>• Rated current related to rated cross-section &amp; min. No. of poles.</li> <li>• Wire end ferrule without plastic collar to DIN 46228/1</li> <li>• Wire end ferrule with plastic collar to DIN 46228/4</li> <li>• P on drawing = pitch</li> <li>• Rated data refer only to the component itself. Clearance and creepage distances to other components are to be designed in accordance with the relevant application standards.</li> <li>• The test point can only be used as potential-pickup point.</li> <li>• The single-position PCB terminal block can be used for voltages up to 1500 V (DC) and 1000 V (AC). The relevant device standard and the appropriate required clearances and creepage distances should be observed in the application</li> <li>• Long term storage of the product with average temperature of 50 °C and average humidity 70%, 36 months</li> </ul>

## Approvals

Approvals



ROHS	Conform
UL File Number Search	UL Website
Certificate No. (cURus)	E60693

## Downloads

Approval/Certificate/Document of Conformity	<a href="#">Declaration of the Manufacturer</a>
Engineering Data	<a href="#">CAD data – STEP</a>
Engineering Data	<a href="#">WSCAD</a>
Product Change Notification	<a href="#">20210909 Color Change of Actuator to LLF(S) and LUF(S) Family</a> <a href="#">20210909 LLF(S) und LUF(S) Familie - Farbänderung des Betätigungselementes</a>
User Documentation	<a href="#">QR-Code product handling video</a> <a href="#">Assembly instruction_Montageanleitung_LLFLUF_EN_DE</a>
Catalogues	<a href="#">Catalogues in PDF-format</a>
Brochures	<a href="#">FL DRIVES EN</a> <a href="#">MB DEVICE MANUF. EN</a> <a href="#">FL DRIVES DE</a> <a href="#">FL APPL_INVERTER EN</a> <a href="#">FL_BASE_STATION_EN</a> <a href="#">FL ELEVATOR EN</a> <a href="#">FL POWER SUPPLY EN</a> <a href="#">FL 72H SAMPLE SER EN</a> <a href="#">PO OMNIMATE EN</a>

Creation date February 9, 2023 8:19:32 AM CET

Catalogue status 03.02.2023 / We reserve the right to make technical changes.

5

**LUF 10.00/09/90V 5.0SN BK BX**

**Weidmüller Interface GmbH & Co. KG**  
 Klingenbergstraße 26  
 D-32758 Detmold  
 Germany

www.weidmueller.com

**Drawings**

**Dimensional drawing**

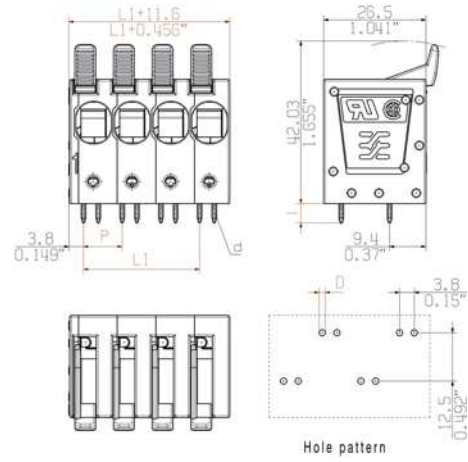

**Derating curve**

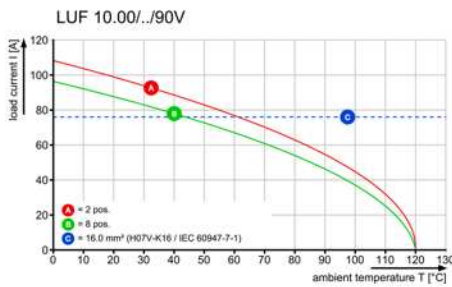

**Derating curve**

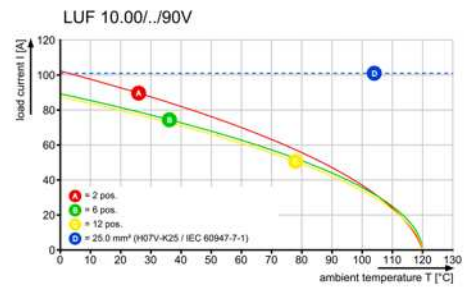

**Product benefits**

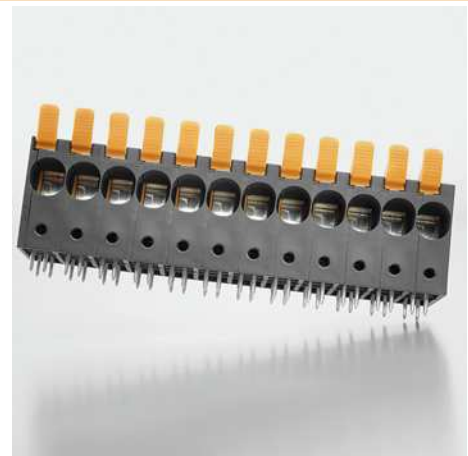

High stability through pin design

**LUF 10.00/09/90V 5.0SN BK BX**

**Weidmüller Interface GmbH & Co. KG**  
Klingenbergstraße 26  
D-32758 Detmold  
Germany

[www.weidmueller.com](http://www.weidmueller.com)

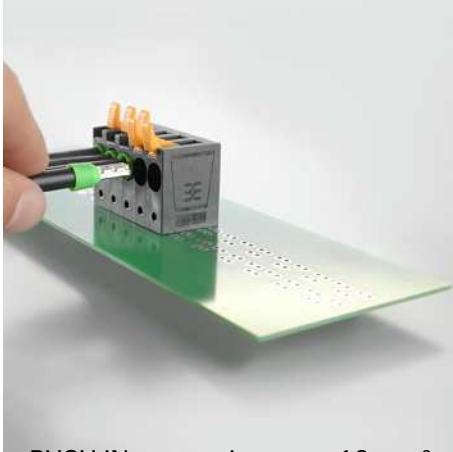
**Drawings****Product benefits**

PUSH IN connection up to 16 mm<sup>2</sup>

## Recommended wave soldering profiles

**Weidmüller Interface GmbH & Co. KG**  
 Klingenbergstraße 16  
 D-32758 Detmold  
 Germany  
 Fon: +49 5231 14-0  
 Fax: +49 5231 14-292083  
 www.weidmueller.com

### Single Wave:

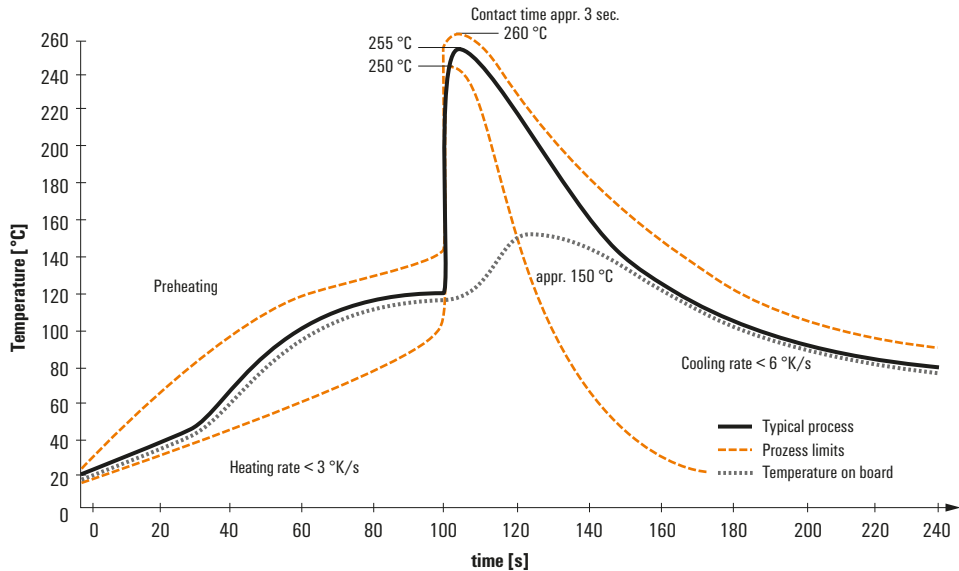

### Double Wave:

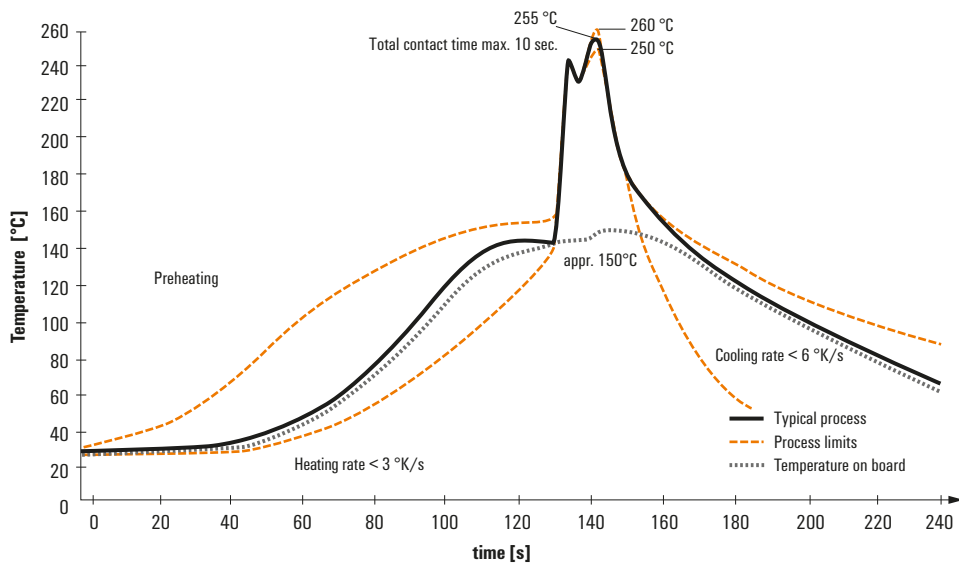

### Wave soldering profiles

Wired connection elements should be processed in accordance with the DIN EN 61760-1 standard. We have included two recommendations for practical wave soldering profiles, with which Weidmüller PCB terminals and connectors are qualified.

When choosing a suitable profile for your application, the following factors also need to be considered:

- PCB thickness
- Proportion of Cu in the layers
- Single/double-sided assembly
- Product range
- Heating and cooling rates

The single and double wave profiles each indicate the recommended operating range, including the maximum soldering temperature of 260°C. In practice, the maximum soldering temperature is quite often well below the above maximum profile.