

SL-SMT 5.08HC/20/180LF 3.2SN BK BX

Weidmüller Interface GmbH & Co. KG
 Klingenbergstraße 26
 D-32758 Detmold
 Germany

www.weidmueller.com

Product image



High-temperature-resistant pin header, packed in box or tape. On tape, with 1.5 mm solder pin, optimised for automatic assembly. 3.2 mm solder pin suitable for reflow and wave soldering. The pin headers provide space for labelling and can be coded. HC = High Current.

General ordering data

| | |
|--------------|---|
| Version | PCB plug-in connector, male header, Solder flange, THT/THR solder connection, 5.08 mm, Number of poles: 20, 180°, Solder pin length (l): 3.2 mm, tinned, black, Box |
| Order No. | 1838620000 |
| Type | SL-SMT 5.08HC/20/180LF 3.2SN BK BX |
| GTIN (EAN) | 4032248348688 |
| Qty. | 12 pc(s). |
| Product data | IEC: 400 V / 27.5 A UL: 300 V / 18.5 A |
| Packaging | Box |

Creation date May 5, 2023 4:16:46 PM CEST

SL-SMT 5.08HC/20/180LF 3.2SN BK BX

Weidmüller Interface GmbH & Co. KG

Klingenbergstraße 26

D-32758 Detmold

Germany

www.weidmueller.com

Technical data

Dimensions and weights

| | | | |
|--------------------------|------------|-----------------|------------|
| Depth | 8.5 mm | Depth (inches) | 0.335 inch |
| Height | 15.2 mm | Height (inches) | 0.598 inch |
| Height of lowest version | 12 mm | Width | 111.4 mm |
| Width (inches) | 4.386 inch | Net weight | 10 g |

Temperatures

| | | | |
|-----------------------------|--------|-----------------------------|--------|
| Operating temperature, min. | -50 °C | Operating temperature, max. | 100 °C |
|-----------------------------|--------|-----------------------------|--------|

System specifications

| | | | |
|--|-------------------------------------|--|---|
| Product family | OMNIMATE Signal - series BL/SL 5.08 | Type of connection | Board connection |
| Mounting onto the PCB | THT/THR solder connection | Pitch in mm (P) | 5.08 mm |
| Pitch in inches (P) | 0.2 inch | Outgoing elbow | 180° |
| Number of poles | 20 | Number of solder pins per pole | 1 |
| Solder pin length (l) | 3.2 mm | Solder pin length tolerance | 0 / -0.3 mm |
| Solder pin dimensions | d = 1.2 mm, Octagonal | Solder eyelet hole diameter (D) | 1.5 mm |
| Solder eyelet hole diameter tolerance (D) | + 0,1 mm | L1 in mm | 96.52 mm |
| L1 in inches | 3.8 inch | Number of rows | 1 |
| Pin series quantity | 1 | Touch-safe protection acc. to DIN VDE 57 106 | finger-safe unplugged/ back-of-hand-safe plugged |
| Touch-safe protection acc. to DIN VDE 0470 | IP20 plugged/ IP10 unplugged | Protection degree | IP20 |
| Volume resistance | ≤5 mΩ | Can be coded | Yes |
| Plugging force/pole, max. | 9 N | Pulling force/pole, max. | 7 N |

Material data

| | | | |
|---------------------------------------|--------------------------------|---------------------------------------|--------------------------------|
| Insulating material | LCP GF | Colour | black |
| Colour chart (similar) | RAL 9011 | Insulating material group | IIIa |
| Comparative Tracking Index (CTI) | ≥ 175 | Moisture Level (MSL) | 1 |
| UL 94 flammability rating | V-0 | Contact material | CuMg |
| Contact surface | tinned | Layer structure of solder connection | 1...3 µm Ni / 2...4 µm Sn matt |
| Layer structure of plug contact | 1...3 µm Ni / 2...4 µm Sn matt | Storage temperature, min. | -40 °C |
| Storage temperature, max. | 70 °C | Operating temperature, min. | -50 °C |
| Operating temperature, max. | 100 °C | Temperature range, installation, min. | -30 °C |
| Temperature range, installation, max. | 100 °C | | |

Rated data acc. to IEC

| | | | |
|---|------------------------|---|--------|
| tested acc. to standard | IEC 60664-1, IEC 61984 | Rated current, min. number of poles (Tu=20°C) | 27.5 A |
| Rated current, max. number of poles (Tu=20°C) | 19 A | Rated current, min. number of poles (Tu=40°C) | 24 A |
| Rated current, max. number of poles (Tu=40°C) | 16.5 A | Rated voltage for surge voltage class / pollution degree II/2 | 400 V |
| Rated voltage for surge voltage class / pollution degree III/2 | 320 V | Rated voltage for surge voltage class / pollution degree III/3 | 250 V |
| Rated impulse voltage for surge voltage class/ pollution degree II/2 | 4 kV | Rated impulse voltage for surge voltage class/ pollution degree III/2 | 4 kV |
| Rated impulse voltage for surge voltage class/ contamination degree III/3 | 4 kV | | |

Creation date May 5, 2023 4:16:46 PM CEST

Catalogue status 28.04.2023 / We reserve the right to make technical changes.

2

SL-SMT 5.08HC/20/180LF 3.2SN BK BX
Weidmüller Interface GmbH & Co. KG

Klingenbergstraße 26

D-32758 Detmold

Germany

www.weidmueller.com

Technical data
Rated data acc. to CSA

| | | | |
|-----------------------------------|---|-----------------------------------|--|
| Institute (CSA) |  | Certificate No. (CSA) | 200039-1176845 |
| Rated voltage (Use group B / CSA) | 300 V | Rated voltage (Use group D / CSA) | 300 V |
| Rated current (Use group D / CSA) | 18.5 A | Reference to approval values | Specifications are maximum values, details - see approval certificate. |

Rated data acc. to UL 1059

| | | | |
|---------------------------------------|---|---------------------------------------|--------|
| Institute (UR) |  | Certificate No. (UR) | E60693 |
| Rated voltage (Use group B / UL 1059) | 300 V | Rated voltage (Use group D / UL 1059) | 300 V |
| Rated current (Use group B / UL 1059) | 18.5 A | Rated current (Use group D / UL 1059) | 10 A |
| Reference to approval values | Specifications are maximum values, details - see approval certificate. | | |

Packing

| | | | |
|-----------|--------|------------|--------|
| Packaging | Box | VPE length | 342 mm |
| VPE width | 133 mm | VPE height | 23 mm |

Classifications

| | | | |
|-------------|-------------|-------------|-------------|
| ETIM 6.0 | EC002637 | ETIM 7.0 | EC002637 |
| ETIM 8.0 | EC002637 | ECLASS 9.0 | 27-44-04-02 |
| ECLASS 9.1 | 27-44-04-02 | ECLASS 10.0 | 27-44-04-02 |
| ECLASS 11.0 | 27-46-02-01 | ECLASS 12.0 | 27-46-02-01 |

Important note

| | |
|----------------|---|
| IPC conformity | Conformity: The products are developed, manufactured and delivered according international recognized standards and norms and comply with the assured properties in the data sheet resp. fulfill decorative properties in accordance with IPC-A-610 "Class 2". Further claims on the products can be evaluated on request. |
| Notes | <ul style="list-style-type: none"> • Gold-plated contact surfaces on request • Rated current related to rated cross-section & min. No. of poles. • Diameter of solder eyelet D = 1.4+0.1mm • Solder eyelet diameter D = 1.5 + 0.1 mm, from 9 poles • P on drawing = pitch • Rated data refer only to the component itself. Clearance and creepage distances to other components are to be designed in accordance with the relevant application standards. • Long term storage of the product with average temperature of 50 °C and average humidity 70%, 36 months |

Data sheet

SL-SMT 5.08HC/20/180LF 3.2SN BK BX

Weidmüller Interface GmbH & Co. KG
 Klingenbergstraße 26
 D-32758 Detmold
 Germany

www.weidmueller.com

Technical data

Approvals

Approvals



| | |
|-----------------------|------------|
| ROHS | Conform |
| UL File Number Search | UL Website |
| Certificate No. (UR) | E60693 |

Downloads

| | |
|---|--|
| Approval/Certificate/Document of Conformity | CB Certificate CB Testreport Declaration of the Manufacturer |
| Engineering Data | CAD data – STEP |
| Engineering Data | WSCAD |
| Product Change Notification | PCN_2017_164_PL30_Gerichtete_Verpackung_SL-SMT5.0x_DE PCN_2017_164_PL30_Sorted_Packaging_SL-SMT5.0x_EN |
| Catalogues | Catalogues in PDF-format |
| Brochures | FL DRIVES EN MB SMT EN FL DRIVES DE MB DEVICE MANUF. EN FL BUILDING SAFETY EN FL APPL LED LIGHTING EN FLIndustr.CONTROLS EN FL MACHINE SAFETY EN FL HEATING ELECTR EN FL APPL INVERTER EN FL_BASE_STATION_EN FL ELEVATOR EN FL POWER SUPPLY EN FL 72H SAMPLE SER EN PO OMNIMATE EN PO OMNIMATE EN |
| White paper surface mount technology | Download Whitepaper |

Data sheet

SL-SMT 5.08HC/20/180LF 3.2SN BK BX

Weidmüller Interface GmbH & Co. KG
 Klingenbergstraße 26
 D-32758 Detmold
 Germany

www.weidmueller.com

Drawings

Product image



Dimensional drawing

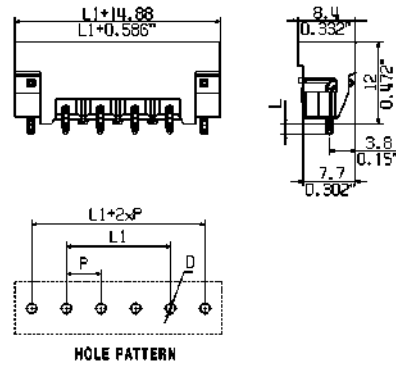

Product benefits



Safe power transmission
 Proven properties

The reproduction, distribution and utilization of this document as well as the communication of its contents to others without explicit authorization is prohibited. Offenders will be held liable for the payment of damages. Weidmüller exclusively reserves the right to file for patents, utility models or designs.

© Weidmüller Interface GmbH & Co. KG

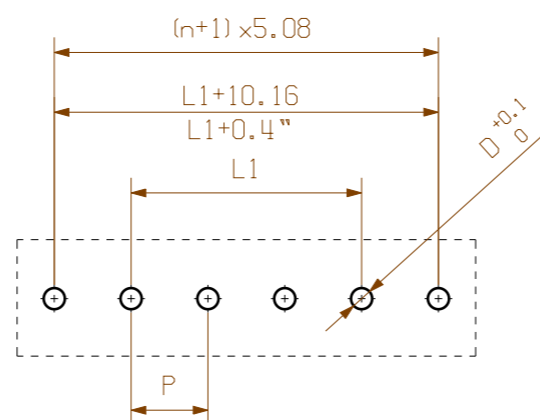
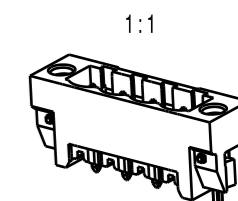
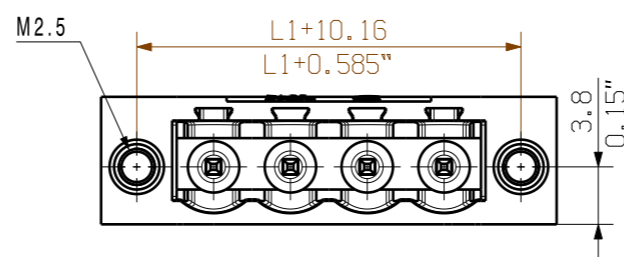
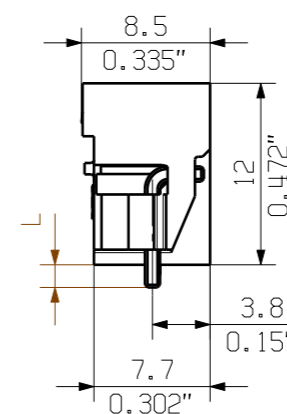
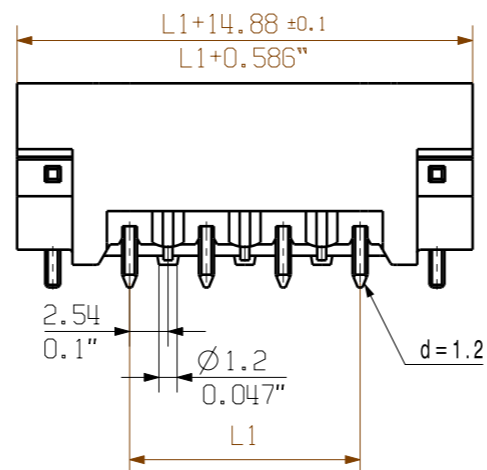

HOLE PATTERN

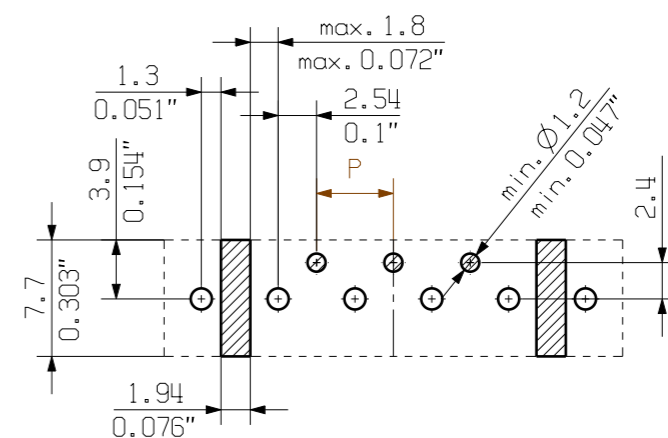

PASTE-FREE AREA

D = 1.5/0.059" (REFLOW SOLDERING)
RECOMMENDATION FOR AUTOMATIC ASSEMBLY

n = POLZAH/ NO OF POLES

P = RASTER/PITCH

SHOWN: SL-SMT 5.08HC/04/180 LF

| | | | | |
|-----|------|----|---------|-----------|
| 1,5 | 0,0 | n | L1 [mm] | L1 [Inch] |
| | -0,3 | | | |
| 3,2 | 0,1 | 24 | 116,84 | 4,600 |
| | -0,3 | 23 | 111,76 | 4,400 |
| 4,5 | 0,1 | 22 | 106,68 | 4,200 |
| | -0,3 | 21 | 101,60 | 4,000 |
| | | 20 | 96,52 | 3,800 |
| | | 19 | 91,44 | 3,600 |
| | | 18 | 86,36 | 3,400 |
| | | 17 | 81,28 | 3,200 |
| | | 16 | 76,20 | 3,000 |
| | | 15 | 71,12 | 2,800 |
| | | 14 | 66,04 | 2,600 |
| | | 13 | 60,96 | 2,400 |
| | | 12 | 55,88 | 2,200 |
| | | 11 | 50,80 | 2,000 |
| | | 10 | 45,72 | 1,800 |
| | | 9 | 40,64 | 1,600 |
| | | 8 | 35,56 | 1,400 |
| | | 7 | 30,48 | 1,200 |
| | | 6 | 25,40 | 1,000 |
| | | 5 | 20,32 | 0,800 |
| | | 4 | 15,24 | 0,600 |
| | | 3 | 10,16 | 0,400 |
| | | 2 | 5,08 | 0,200 |

For the mounting of PCBs, it should be noted that the rated data relates only to the PCB components alone. The necessary creepage and clearance paths must be observed in connection with the respective applicant in accordance to IEC 664 / VDE 0110. The current-carrying capacity and pitch tolerance is to be determined according to DIN IEC 326 part 3 very fine.

Weidmüller PCB components are tested to the DIN EN 61984 standard, and are valid for its field of application. Provided that the components are used to the intended purpose, all requirements with respect to the occurring of electrical, mechanical, thermic and corrosive stress will be satisfied.

| | | | | | |
|---------------|----------------|----------------------------------|----------|---|--|
| | DIN ISO 2768-m | 106339/4 30.07.18 HERTEL_S 01 | | Cat.no.: . | |
| | Modification | | | C 34148 23 | |
| | Drawn | 30.11.2007 | HELIS_MA | Drawing no. Issue no. | |
| | Responsible | | HERTEL_S | Sheet 03 of 04 sheets | |
| | Checked | 01.08.2018 | KOCH_JG | | |
| Supersedes: . | Approved | | LANG_T | Product file: SL-SMT 5.08HC 7280 | |

SL-SMT 5.08HC/.../180...
STIFTLAENGE
MALE HEADER

Recommended wave soldering profiles

Weidmüller Interface GmbH & Co. KG
 Klängenbergstraße 16
 D-32758 Detmold
 Germany
 Fon: +49 5231 14-0
 Fax: +49 5231 14-292083
 www.weidmueller.com

Single Wave:



Double Wave:



Wave soldering profiles

Wired connection elements should be processed in accordance with the DIN EN 61760-1 standard. We have included two recommendations for practical wave soldering profiles, with which Weidmüller PCB terminals and connectors are qualified.

When choosing a suitable profile for your application, the following factors also need to be considered:

- PCB thickness
- Proportion of Cu in the layers
- Single/double-sided assembly
- Product range
- Heating and cooling rates

The single and double wave profiles each indicate the recommended operating range, including the maximum soldering temperature of 260°C. In practice, the maximum soldering temperature is quite often well below the above maximum profile.

Recommended reflow soldering profile

Weidmüller Interface GmbH & Co. KG
 Klingenbergstraße 16
 D-32758 Detmold
 Germany
 Fon: +49 5231 14-0
 Fax: +49 5231 14-292083
 www.weidmueller.com



Reflow soldering profile

The perfect soldering profile for SMT Surface Mount Technology is one the most exiting question in SMT production. But there are more than one correct answer: The diagram of temperature-on-time is related to processing features of solder paste and to maximum load of components.

We have to consider the following parameters:

- Time for pre heating
- Maximum temperature
- Time above melting point
- Time for cooling
- Maximum heating rate
- Maximum cooling rate

We recommend a typical solder profile with associated process limits. With preheating components and board are prepared smoothly for the solder phase. Heating rate is typically $\leq +3\text{K/s}$. In parallel the solder paste is ‚activated‘. The time above melting point of 217°C the paste gets liquid and components and boards begin to connect. The maximum temperature of 245°C to 254°C should stay between 10 and 40 seconds. In the cooling phase at $\geq -6\text{K/s}$ solder is cured. Board and components cool down while avoiding cold cracks.