

OMNIMATE Signal - series LM
LM3R 5.08/09/90 3.5SN OR BX

Weidmüller Interface GmbH & Co. KG
 Klingenbergstraße 16
 D-32758 Detmold
 Germany
 Fon: +49 5231 14-0
 Fax: +49 5231 14-292083
 www.weidmueller.com

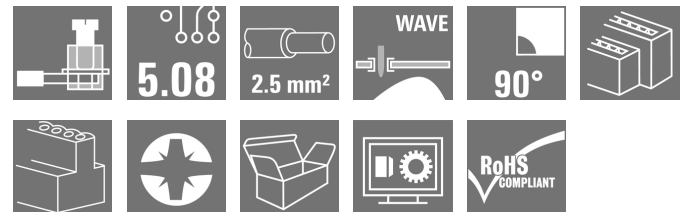

Single- and multi-row PCB terminal with proven clamping yoke connection at 5.08 mm pitch. Suitable for conductor cross-sections up to 2.5 mm².

General ordering data

Type	LM3R 5.08/09/90 3.5SN OR BX
Order No.	1769630000
Version	PCB terminal, 5.08 mm, No. of poles: 9, 90°, Solder pin length (l): 3.5 mm, tinned, Orange, Clamping yoke connection, Clamping range, max.: 2.5 mm ² , Box
GTIN (EAN)	4032248116997
Qty.	50 pc(s).
Product data	IEC: 630 V / 17.5 A / 0.2 - 2.5 mm ² UL: 300 V / 15 A / AWG 24 - AWG 14
Packaging	Box

OMNIMATE Signal - series LM
LM3R 5.08/09/90 3.5SN OR BX

Weidmüller Interface GmbH & Co. KG
 Klingenbergstraße 16
 D-32758 Detmold
 Germany
 Fon: +49 5231 14-0
 Fax: +49 5231 14-292083
 www.weidmueller.com

Technical data
Dimensions and weights

Width	18.78 mm	Width (inches)	0.739 inch
Height	40.1 mm	Height (inches)	1.579 inch
Height of lowest version	36.6 mm	Depth	31.8 mm
Depth (inches)	1.252 inch	Net weight	15.24 g

System parameters

Product family	OMNIMATE Signal - series LM	Wire connection method	Clamping yoke connection
Mounting onto the PCB	THT solder connection	Conductor outlet direction	90°
Pitch in mm (P)	5.08 mm	Pitch in inches (P)	0.2 inch
No. of poles	9	Fitted by customer	Yes
Max. adjacent poles per row	72	Solder pin length (l)	3.5 mm
Solder pin dimensions	0.95 x 0.8 mm	Solder eyelet hole diameter (D)	1.3 mm
Solder eyelet hole diameter tolerance (D)+ 0,1 mm		Number of solder pins per pole	1
Screwdriver blade	0.6 x 3.5	Screwdriver blade standard	DIN 5264
Tightening torque, min.	0.4 Nm	Tightening torque, max.	0.5 Nm
Clamping screw	M 2.5	Stripping length	6 mm
L1 in mm	10.16 mm	L1 in inches	0.4 inch
Touch-safe protection acc. to DIN VDE 0470	IP 20	Touch-safe protection acc. to DIN VDE 57 106	Safe from finger touch
Volume resistance	1.20 mΩ		

Material data

Insulating material	Wemid (PA)	Colour	Orange
Colour chart (similar)	RAL 2000	Insulating material group	I
CTI	≥ 600	Insulation resistance	≥ 10 ⁸ Ω
UL 94 flammability rating	V-0	Contact material	Copper alloy
Contact surface	tinned	Coating	1-3 μm Ni, 4-6 μm SN
Tinning type	matt	Layer structure of solder connection	1-3 μm Ni / 4-6 μm Sn matt
Storage temperature, min.	-25 °C	Storage temperature, max.	55 °C
Max. relative humidity during storage	80 %	Operating temperature, min.	-50 °C
Operating temperature, max.	120 °C	Temperature range, installation, min.	-25 °C
Temperature range, installation, max.	120 °C		

Conductors suitable for connection

Clamping range, min.	0.2 mm ²	Clamping range, max.	2.5 mm ²
Wire connection cross section AWG, min.	AWG 24	Wire connection cross section AWG, max.	AWG 14
Solid, min. H05(07) V-U	0.2 mm ²	Solid, max. H05(07) V-U	2.5 mm ²
Flexible, min. H05(07) V-K	0.2 mm ²	Flexible, max. H05(07) V-K	2.5 mm ²
w. plastic collar ferrule, DIN 46228 pt 4, min.	0.25 mm ²	w. plastic collar ferrule, DIN 46228 pt 4, max.	1.5 mm ²
w. wire end ferrule, DIN 46228 pt 1, min.	0.25 mm ²	w. wire end ferrule, DIN 46228 pt 1, max.	1.5 mm ²
Plug gauge in accordance with EN 60999 a x b; ø	2.4 mm x 1.5 mm; 1.9mm		

**OMNIMATE Signal - series LM
LM3R 5.08/09/90 3.5SN OR BX**

Weidmüller Interface GmbH & Co. KG
Klingenbergstraße 16
D-32758 Detmold
Germany
Fon: +49 5231 14-0
Fax: +49 5231 14-292083
www.weidmueller.com

Technical data
Rated data acc. to IEC

tested acc. to standard	IEC 60664-1, IEC 61984	Rated current, min. no. of poles (Tu=20°C)	17.5 A
Rated current, max. no. of poles (Tu=20°C)	16 A	Rated current, min. no. of poles (Tu=40°C)	17.5 A
Rated current, max. no. of poles (Tu=40°C)	14.2 A	Rated voltage for surge voltage class / pollution degree II/2	630 V
Rated voltage for surge voltage class / pollution degree III/2	320 V	Rated voltage for surge voltage class / pollution degree III/3	250 V
Rated impulse voltage for surge voltage class/ pollution degree II/2	4 kV	Rated impulse voltage for surge voltage class/ pollution degree III/2	4 kV
Rated impulse voltage for surge voltage class/ contamination degree III/3	4 kV	Short-time withstand current resistance	3 x 1s with 120 A

Rated data acc. to CSA

Institute (CSA)		Certificate No. (CSA)	200039-1815154
Rated voltage (Use group B / CSA)	300 V	Rated voltage (Use group D / CSA)	300 V
Rated current (Use group B / CSA)	18 A	Rated current (Use group D / CSA)	10 A
Wire cross-section, AWG, min.	AWG 24	Wire cross-section, AWG, max.	AWG 14
Reference to approval values	Specifications are maximum values, details - see approval certificate.		

Rated data acc. to UL 1059

Institute (cURus)		Certificate No. (cURus)	E60693
Rated voltage (Use group B / UL 1059)	300 V	Rated voltage (Use group D / UL 1059)	300 V
Rated current (Use group B / UL 1059)	15 A	Rated current (Use group D / UL 1059)	10 A
Wire cross-section, AWG, min.	AWG 24	Wire cross-section, AWG, max.	AWG 14
Reference to approval values	Specifications are maximum values, details - see approval certificate.		

Packaging

Packaging	Box	VPE length	54 mm
VPE width	170 mm	VPE height	220 mm

Classifications

ETIM 3.0	EC001284	ETIM 4.0	EC002643
ETIM 5.0	EC002643	ETIM 6.0	EC002643
UNSPSC	30-21-18-01	eClass 6.2	27-26-11-01
eClass 7.1	27-44-04-01	eClass 8.1	27-44-04-01
eClass 9.0	27-44-04-01	eClass 9.1	27-44-04-01

Data sheet

**OMNIMATE Signal - series LM
LM3R 5.08/09/90 3.5SN OR BX**

Weidmüller Interface GmbH & Co. KG
Klingenbergstraße 16
D-32758 Detmold
Germany
Fon: +49 5231 14-0
Fax: +49 5231 14-292083
www.weidmueller.com

Technical data

Notes

- | | |
|-------|---|
| Notes | <ul style="list-style-type: none"> • Rated current related to rated cross-section & min. No. of poles. • Wire end ferrule without plastic collar to DIN 46228/1 • Wire end ferrule with plastic collar to DIN 46228/4 • P on drawing = pitch • Rated data refer only to the component itself. Clearance and creepage distances to other components are to be designed in accordance with the relevant application standards. |
|-------|---|

IPC conformity	Conformity: The products are developed, manufactured and delivered according international recognized standards and norms and comply with the assured properties in the data sheet resp. fulfill decorative properties in accordance with IPC-A-610 "Class 2". Further claims on the products can be evaluated on request.
----------------	--

Approvals

Approvals



ROHS	Conform
------	---------

Downloads

Approval/Certificate/Document of Conformity	Declaration of the Manufacturer
Brochure/Catalogue	FL DRIVES EN FL ANALO.SIGN.CONV. EN MB DEVICE MANUF. EN FL DRIVES DE CAT 2 PORTFOLIOGUIDE EN FL BUILDING SAFETY EN FL APPL LED LIGHTING EN FLIndustr.CONTROLS EN FL MACHINE SAFETY EN FL HEATING ELECTR EN FL APPL INVERTER EN FL_BASE_STATION_EN FL ELEVATOR EN FL POWER SUPPLY EN FL 72H SAMPLE SER EN PO OMNIMATE EN
Engineering Data	EPLAN, WSCAD
Engineering Data	LM3R.zip

**OMNIMATE Signal - series LM
LM3R 5.08/09/90 3.5SN OR BX**

Weidmüller Interface GmbH & Co. KG
Klingenbergstraße 16
D-32758 Detmold
Germany
Fon: +49 5231 14-0
Fax: +49 5231 14-292083
www.weidmueller.com

Drawings

Dimensional drawing

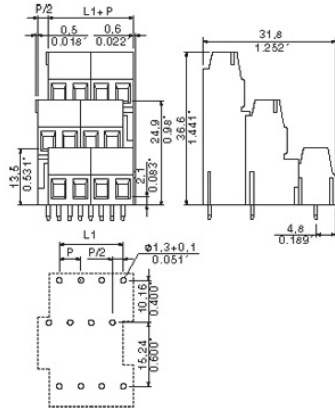

Graph

Technical Data 07

Rev.

Material data

Insulation material type	PA 66/6(WEMID)
Insulation material colours	orange,black,green,greys
Insulation material flammability class	UL94
Insulation resistance	MΩhm
Contact base material	Cu-alloy
Contact plating	Tin-plated

System characteristic values

Pitch P	mm/inch	5.08 / 0.200
Number of rows		3
Dielectric strength (r.m.s withstand voltage)	kV	>2.5
Through resistance (typical)	mΩhm	1.7
Operating temperature range	°C	-55°...+120° 1)
Degree of protection acc. to VDE 0106		finger safe
Degree of protection acc. to DIN EN 60529		IP20
Conductor connection method		clamping yoke
Screw size		M2.5
Screw torque max. acc. to EN 60999	Nm	0.4 - 0.5
Screwdriver type		SD 0.6 x 3.5 / SDK PZ0
Solder pin length L	mm/inch	3.5 / 0.138
PCB hole diameter D (wave soldering)	mm/inch	1.3+0.10/0.051+0.004 2)
PCB hole diameter D (reflow soldering)	mm/inch	n.a. 3)
Resistance to soldering heat acc. to DIN IEC 60512-6	°C/sec	260/10 4)
Resistance to soldering heat acc. to EN 61760-1	°C/sec	n.a. 5)
Solderability classification acc. to EN 61760-1		n.a.
Solder connection type		wave soldering
Solder pin diameter d (max.)	mm/inch	1.24/0.049

Application notes

Coding possibility	yes/no	no
Joinable without loss of pitch	yes/no	yes
Manual assembly of modules	yes/no	yes
Max. number of poles		72

Conductor

Clamping range	mm ²	0.20 - 2.5
"e" solid H05(07) V-U	mm ²	0.20 - 2.5
"f" flexible H05(07) V-K	mm ²	0.20 - 1.5
"f" with ferrule acc. to DIN 46228/1	mm ²	0.25 - 1.5
... with plastic collar acc. to DIN 46228/4	mm ²	0.25 - 1.5
Conductor insulation stripping length	mm/inch	6.0
Conductor insulation diameter max.	mm/inch	n.a.
Two wire clamping range	mm ²	n.a.
Gauge to EN 60999 (a x b ; Ø)	mm	2.4x1.5 (A1); Ø1.9 (B1)

IEC 664-1 / VDE0110 (4.97) rated data

Rated cross section acc. to EN 60999	mm ²	1.5
Rated current @ 20°C ambient (min. pole , max. wire)	A	17.5 6)
Rated current @ 40°C ambient (min. pole , max. wire)	A	17.5 6)

Overvoltage category / Pollution degree

Rated voltage	V	250	320	630
Rated impulse voltage	kV	4.0	4.0	4.0

UL 1059 rated data File No.: E60693

Rated voltage	V	300	n.a.	300
Rated current	A	15	n.a.	10
AWG wire range (field wiring / factory wiring)		24 - 14		

CSA C22.2 rated data File No.: LR12400

Rated voltage	V	300	n.a.	300
Rated current	A	18	n.a.	10
AWG wire range (field wiring / factory wiring)		24 - 14		

Packaging

cardboard box

Downloads

www.weidmueller.de

- 1) Sum of ambient temperature and temperature rise
- 2) Recommendation for manual assembly
- 3) Recommendation for automatic assembly
- 4) Recommendation for wave soldering
- 5) Recommendation for reflow soldering
- 6) Referred to rated cross section and minimum pole number

n.a. = not applicable

Subject to technical changes

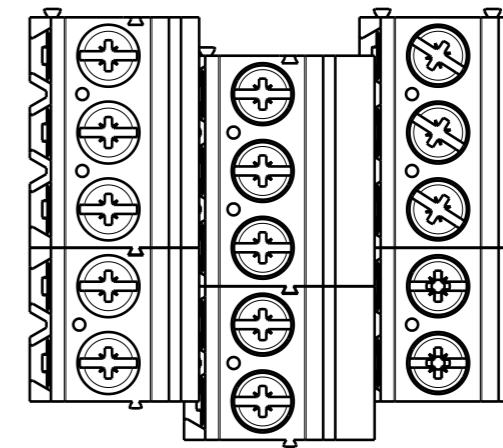
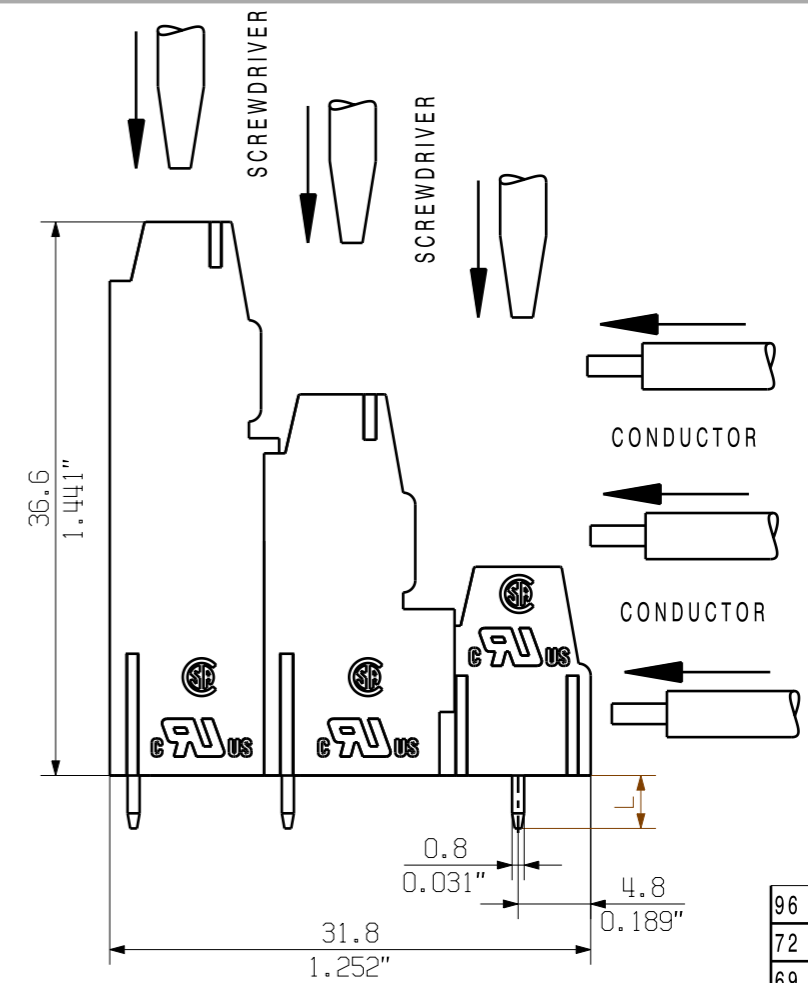
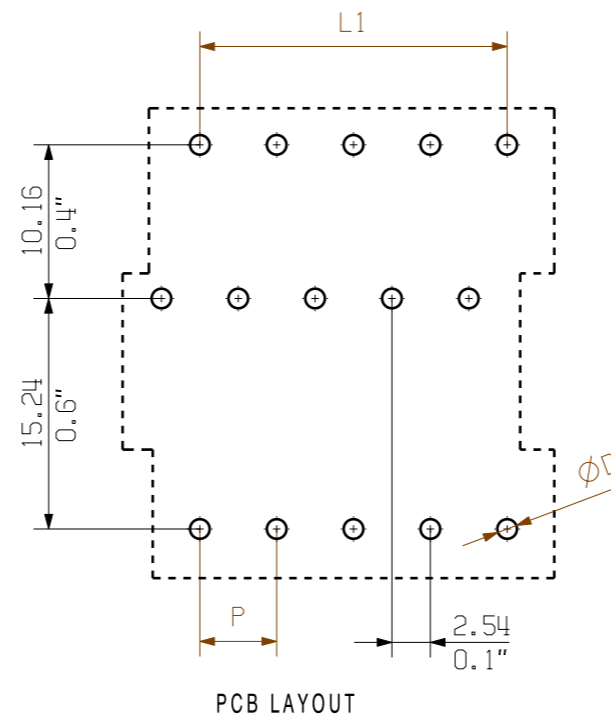
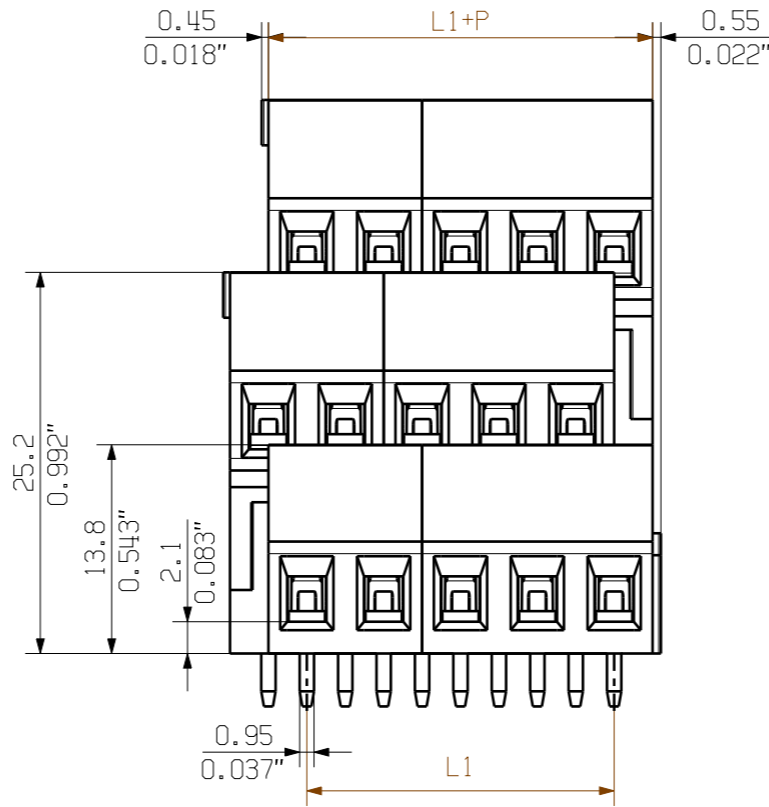

KUNDENZEICHNUNG
CUSTOMER DRAWING

96	157.48	6.200
72	116.84	4.600
69	111.76	4.400
66	106.68	4.200
63	101.60	4.000
60	96.52	3.800
57	91.44	3.600
54	86.36	3.400
51	81.28	3.200
48	76.20	3.000
45	71.12	2.800
42	66.04	2.600
39	60.96	2.400
36	55.88	2.200
33	50.80	2.000
30	45.72	1.800
27	40.64	1.600
24	35.56	1.400
21	30.48	1.200
18	25.40	1.000
15	20.32	0.800
12	15.24	0.600
9	10.16	0.400
6	5.08	0.200
N	L1 [mm]	L1 [inch]

For the mounting of PCBs, it should be noted that the rated data stated here relates only to the PCB components alone.

The necessary creepage and clearance paths must be observed in connection with the respective applicant in accordance to IEC 664 / VDE 0110. The current-carrying capacity and pitch tolerance is to be determined according to DIN IEC 326 part 3 very fine.

Weidmüller PCB components are tested to the DIN EN 61984 standard, and are valid for its field of application. Provided that the components are used to the intended purpose, all requirements with respect to the occurring of electrical, mechanical, thermic and corrosive stress will be satisfied.

SHOWN: LM3R 5.08/15

METRIC TOLERANCES X. = ±0.3 X.X = ±0.1 X.XX = ±0.05	66212/5 14.12.12 SHI_S 01	Weidmüller		CAT.NO.: C 41739 07
SCALE: 2/1	MODIFICATION	DATE	NAME	DRAWING NO. ISSUE NO.
SUPERSEDES: 4 29162/01	DRAWN	01.04.2005	XU_S	
SUPERSEDED BY: .	RESPONSIBLE		GE_G	
	CHECKED	20.07.2007	RUHNAU_S	
	APPROVED		XU_S	
				PRODUCT FILE: LM3R 5.08 7065

LM3R 5.08/...
LEITERPLATTENKLEMME
PCB TERMINAL

WEITERGABE SOWIE Vervielfältigung dieses Dokuments, Verwertung und Mitteilung seines Inhalts sind verboten, soweit nicht ausdrücklich gestattet. Zuwiderhandlungen verpflichten zu Schadenersatz. Alle Rechte für den Fall der Patent-, Gebrauchsmuster- oder Geschmacksstoffrechte vorbehalten. THE REPRODUCTION, DISTRIBUTION AND UTILIZATION OF THIS DOCUMENT AS WELL AS THE COMMUNICATION OF ITS CONTENTS TO OTHERS WITHOUT EXPLICIT AUTHORIZATION IS PROHIBITED. OFFENDERS WILL BE HELD LIABLE FOR THE PAYMENT OF DAMAGES. ALL RIGHTS RESERVED IN THE EVENT OF A PATENT, UTILITY MODEL OR DESIGN.

Recommended wave soldering profiles

Weidmüller Interface GmbH & Co. KG
 Klängenbergstraße 16
 D-32758 Detmold
 Germany
 Fon: +49 5231 14-0
 Fax: +49 5231 14-292083
 www.weidmueller.com

Single Wave:



Double Wave:



Wave soldering profiles

Wired connection elements should be processed in accordance with the DIN EN 61760-1 standard. We have included two recommendations for practical wave soldering profiles, with which Weidmüller PCB terminals and connectors are qualified.

When choosing a suitable profile for your application, the following factors also need to be considered:

- PCB thickness
- Proportion of Cu in the layers
- Single/double-sided assembly
- Product range
- Heating and cooling rates

The single and double wave profiles each indicate the recommended operating range, including the maximum soldering temperature of 260°C. In practice, the maximum soldering temperature is quite often well below the above maximum profile.