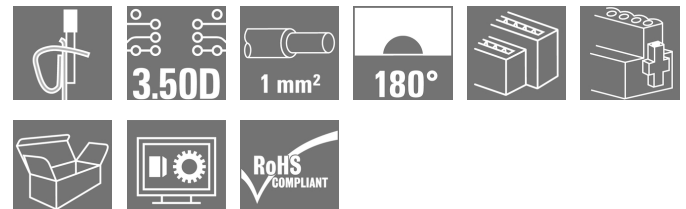

**OMNIMATE Signal - series B2L/S2L 3.50 - 2-row  
B2L 3.50/32/180F SN OR BX**

**Weidmüller Interface GmbH & Co. KG**  
 Klingenbergstraße 26  
 D-32758 Detmold  
 Germany  
 Fon: +49 5231 14-0  
 Fax: +49 5231 14-292083  
 www.weidmueller.com

**Product image**

Similar to illustration

**Component density redefined: the future standard for signal connection**

A maximum number of connections requiring minimum space - the double-row B2L sets the bar for field connections of typical sensor cables up to 1 mm<sup>2</sup> very high and closes the gap between "less space" and "more functions".

The result is a connection solution for standard industrial cables in 1.75 pitch - 30% smaller than equivalent solutions in 2.5 pitch, and with the 140% robustness of the 3.5 pitch

Dimensions: double the connection density with a 3.5mm pitch size

Connection system: tried and tested maintenance-free Weidmüller tension clamp connection

The basic application advantages:

Efficient: maximum component density on the PCB

Suitable for industrial use - minimum dimensions, maximum robustness

Process-optimised - automatic assembly and reflow soldering, fast connection

User-friendly - patented release lever for the easy release of larger numbers of poles

Application-oriented: easy labelling and reliable coding despite compact dimensions

Miniaturisation is more than just a larger number of functions within a smaller space:

Each reduction in size decreases space requirements and so reduces overall system costs for the end customer. Thus, Weidmüller fulfils a growing demand in the engineering and industrial automation sectors.

**General ordering data**

Type	B2L 3.50/32/180F SN OR BX
Order No.	<a href="#">1748140000</a>
Version	PCB plug-in connector, female plug, 3.50 mm, Number of poles: 32, 180°, Tension-clamp connection, Clamping range, max.: 1 mm <sup>2</sup> , Box
GTIN (EAN)	4032248194216
Qty.	24 pc(s).
Product data	IEC: 250 V / 10.3 A / 0.2 - 1 mm <sup>2</sup> UL: 300 V / 10 A / AWG 28 - AWG 16
Packaging	Box

**OMNIMATE Signal - series B2L/S2L 3.50 - 2-row  
B2L 3.50/32/180F SN OR BX**

**Weidmüller Interface GmbH & Co. KG**  
 Klingenbergstraße 26  
 D-32758 Detmold  
 Germany  
 Fon: +49 5231 14-0  
 Fax: +49 5231 14-292083  
 www.weidmueller.com

**Technical data****Dimensions and weights**

Width	62.8 mm	Width (inches)	2.472 inch
Height	15.7 mm	Height (inches)	0.618 inch
Depth	20.6 mm	Depth (inches)	0.811 inch
Net weight	15.5 g		

**System Parameters**

Product family	OMNIMATE Signal - series B2L/S2L 3.50 - 2-row	Type of connection	Field connection
Wire connection method	Tension-clamp connection	Pitch in mm (P)	3.5 mm
Pitch in inches (P)	0.138 inch	Conductor outlet direction	180°
Number of poles	32	L1 in mm	52.5 mm
L1 in inches	2.067 inch	Number of rows	1
Pin series quantity	2	Rated cross-section	1 mm <sup>2</sup>
Touch-safe protection acc. to DIN VDE 57 106	Safe from finger touch	Touch-safe protection acc. to DIN VDE 0470	IP 20
Can be coded	Yes	Stripping length	7 mm
Tightening torque for screw flange, min.	0.2 Nm	Tightening torque for screw flange, max.	0.25 Nm
Screwdriver blade	0.4 x 2.5	Screwdriver blade standard	DIN 5264
Plugging cycles	25	Plugging force/pole, max.	5 N
Pulling force/pole, max.	4 N		

**Material data**

Insulating material	PBT	Colour	orange
Colour chart (similar)	RAL 2000	Insulation strength	≥ 10 <sup>8</sup> Ω
UL 94 flammability rating	V-0	GWFI	960 °C
Contact material	Copper alloy	Contact surface	tinned
Storage temperature, min.	-25 °C	Storage temperature, max.	55 °C
Max. relative humidity during storage	80 %	Operating temperature, min.	-50 °C
Operating temperature, max.	100 °C	Temperature range, installation, min.	-30 °C
Temperature range, installation, max.	100 °C		

**Conductors suitable for connection**

Clamping range, min.	0.08 mm <sup>2</sup>
Clamping range, max.	1 mm <sup>2</sup>
Wire connection cross section AWG, min.	AWG 28
Wire connection cross section AWG, max.	AWG 18
Solid, min. H05(07) V-U	0.2 mm <sup>2</sup>
Solid, max. H05(07) V-U	1 mm <sup>2</sup>
Flexible, min. H05(07) V-K	0.2 mm <sup>2</sup>
Flexible, max. H05(07) V-K	1 mm <sup>2</sup>
w. plastic collar ferrule, DIN 46228 pt 4, min.	0.14 mm <sup>2</sup>
w. plastic collar ferrule, DIN 46228 pt 4, max.	0.34 mm <sup>2</sup>
w. wire end ferrule, DIN 46228 pt 1, min.	0.14 mm <sup>2</sup>
w. wire end ferrule, DIN 46228 pt 1, max.	0.34 mm <sup>2</sup>

**OMNIMATE Signal - series B2L/S2L 3.50 - 2-row  
B2L 3.50/32/180F SN OR BX**

**Weidmüller Interface GmbH & Co. KG**  
Klingenbergstraße 26  
D-32758 Detmold  
Germany  
Fon: +49 5231 14-0  
Fax: +49 5231 14-292083  
www.weidmueller.com

**Technical data**

Clampable conductor	Cross-section for conductor connection	Type	fine-wired
	wire end ferrule	nominal	0.14 mm <sup>2</sup>
	Cross-section for conductor connection	Stripping length	nominal 10 mm
		Recommended wire-end ferrule	<a href="#">HO.14/12 GR SV</a>
Reference text	Cross-section for conductor connection	Type	fine-wired
	wire end ferrule	nominal	0.25 mm <sup>2</sup>
	Cross-section for conductor connection	Stripping length	nominal 10 mm
		Recommended wire-end ferrule	<a href="#">HO.25/12 HBL</a>
Reference text	The outside diameter of the plastic collar should not be larger than the pitch (P). Length of ferrules is to be chosen depending on the product and the rated voltage.		
Max. clamping range	1 mm <sup>2</sup>		

**Rated data acc. to IEC**

tested acc. to standard	IEC 60664-1, IEC 61984	
Rated current, max. number of poles (Tu=20°C)	8.7 A	Rated current, min. number of poles (Tu=20°C) 10.3 A
Rated current, max. number of poles (Tu=40°C)	7.4 A	Rated current, min. number of poles (Tu=40°C) 8.9 A
Rated voltage for surge voltage class / pollution degree III/2	160 V	Rated voltage for surge voltage class / pollution degree II/2 250 V
Rated impulse voltage for surge voltage class/ pollution degree II/2	2.5 kV	Rated voltage for surge voltage class / pollution degree III/3 80 V
Rated impulse voltage for surge voltage class/ contamination degree III/3	2.5 kV	Rated impulse voltage for surge voltage class/ pollution degree III/2 2.5 kV
		Short-time withstand current resistance 3 x 1s with 77 A

**Rated data acc. to CSA**

Institute (CSA)		Certificate No. (CSA)	200039-1488444
Rated voltage (Use group B / CSA)	300 V	Rated current (Use group B / CSA)	5 A
Wire cross-section, AWG, min.	AWG 28	Wire cross-section, AWG, max.	AWG 18
Reference to approval values	Specifications are maximum values, details - see approval certificate.		

**Rated data acc. to UL 1059**

Institute (UR)		Certificate No. (UR)	E60693
Rated voltage (Use group B / UL 1059)	300 V	Rated voltage (Use group C / UL 1059)	50 V
Rated current (Use group B / UL 1059)	10 A	Rated current (Use group C / UL 1059)	10 A
Wire cross-section, AWG, min.	AWG 28	Wire cross-section, AWG, max.	AWG 16
Reference to approval values	Specifications are maximum values, details - see approval certificate.		

**Packing**

Packaging	Box	VPE length	52 mm
VPE width	76 mm	VPE height	192 mm

Creation date February 3, 2020 5:18:39 AM CET

Catalogue status 24.01.2020 / We reserve the right to make technical changes.

**OMNIMATE Signal - series B2L/S2L 3.50 - 2-row  
B2L 3.50/32/180F SN OR BX**

**Weidmüller Interface GmbH & Co. KG**  
Klingenbergstraße 26  
D-32758 Detmold  
Germany  
Fon: +49 5231 14-0  
Fax: +49 5231 14-292083  
www.weidmueller.com

**Technical data**
**Classifications**

ETIM 6.0	EC002638	ETIM 7.0	EC002638
eClass 9.0	27-44-03-09	eClass 9.1	27-44-03-09
eClass 10.0	27-44-03-09	UNSPSC	30-21-18-10

**Notes**

Notes	<ul style="list-style-type: none"> <li>• Additional colours on request</li> <li>• Gold-plated contact surfaces on request</li> <li>• Rated current related to rated cross-section &amp; min. No. of poles.</li> <li>• Wire end ferrule with plastic collar to DIN 46228/4</li> <li>• Wire end ferrule without plastic collar to DIN 46228/1</li> <li>• P on drawing = pitch</li> <li>• Crimp shape A for wire-end ferrules with crimping tools PZ 1,5 (order no. 9005990000) or PZ 6/5 (order no. 9011460000) for larger wire cross-sections recommended.</li> <li>• Rated data refer only to the component itself. Clearance and creepage distances to other components are to be designed in accordance with the relevant application standards.</li> </ul>
IPC conformity	Conformity: The products are developed, manufactured and delivered according international recognized standards and norms and comply with the assured properties in the data sheet resp. fulfill decorative properties in accordance with IPC-A-610 "Class 2". Further claims on the products can be evaluated on request.

**Approvals**

Approvals



ROHS

Conform

**Downloads**

Approval/Certificate/Document of Conformity	<a href="#">Declaration of the Manufacturer</a>
Brochure/Catalogue	<a href="#">FL DRIVES EN</a> <a href="#">MB DEVICE MANUF. EN</a> <a href="#">FL DRIVES DE</a> <a href="#">FL BUILDING SAFETY EN</a> <a href="#">FL APPL LED LIGHTING EN</a> <a href="#">FL INDUSTR.CONTROLS EN</a> <a href="#">FL MACHINE SAFETY EN</a> <a href="#">FL HEATING ELECTR EN</a> <a href="#">FL APPL INVERTER EN</a> <a href="#">FL_BASE_STATION_EN</a> <a href="#">FL ELEVATOR EN</a> <a href="#">FL POWER SUPPLY EN</a> <a href="#">FL 72H SAMPLE SER EN</a> <a href="#">PO OMNIMATE EN</a>
Engineering Data	<a href="#">EPLAN_WSCAD</a>
Engineering Data	<a href="#">STEP</a>

Creation date February 3, 2020 5:18:39 AM CET

Catalogue status 24.01.2020 / We reserve the right to make technical changes.

**OMNIMATE Signal - series B2L/S2L 3.50 - 2-row  
B2L 3.50/32/180F SN OR BX**

**Weidmüller Interface GmbH & Co. KG**  
Klingenbergstraße 26  
D-32758 Detmold  
Germany  
Fon: +49 5231 14-0  
Fax: +49 5231 14-292083  
www.weidmueller.com

**Drawings**

**Dimensional drawing**

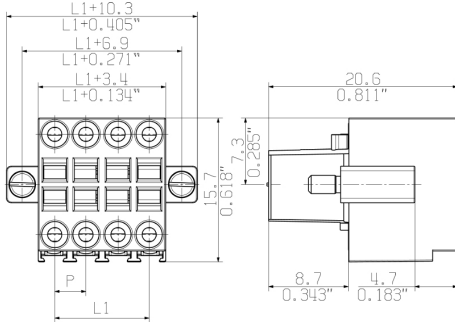

**Graph**

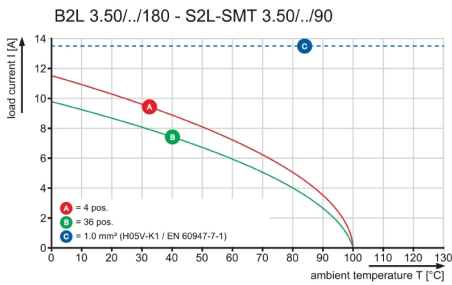

**Graph**

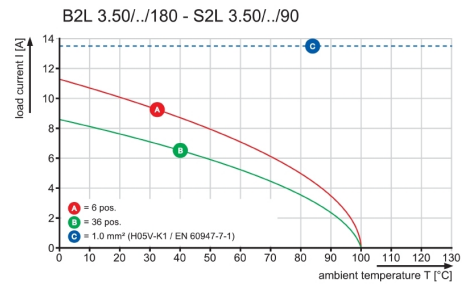

**Graph**

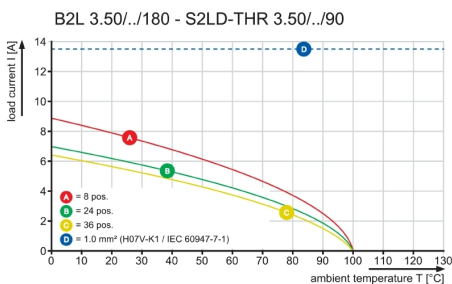

MASSE OHNE TOLERANZ SIND KEINE PRUEFMASSE  
 DIMS. WITHOUT TOLERANCE ARE NOT CONTROL DIMS.

DIE DEUTSCHE VERSION IST VERBINDLICH  
 THE GERMAN VERSION IS BINDING

WEITERGABE SOWIE VERVIELFAELTIGUNG DIESES DOKUMENTS, VERWERTUNG UND MITTEILUNG SEINES INHALTS SIND VERBOTEN, SOWEIT NICHT AUSDRUECKLICH GESTATTET.  
 ZUWIDERHANDLUNGEN VERPFLICHTEN ZU SCHADENERSATZ. ALLE RECHTE FUER DEN FALL DER PATENT-, GEBRAUCHSMUSTER- ODER GESCHMACKSMUSTEREINTRAGUNG VORBEHALTEN.  
 THE REPRODUCTION, DISTRIBUTION AND UTILIZATION OF THIS DOCUMENT AS WELL AS THE COMMUNICATION OF ITS CONTENTS TO OTHERS WITHOUT EXPLICIT AUTHORIZATION IS PROHIBITED.  
 OFFENDERS WILL BE HELD LIABLE FOR THE PAYMENT OF DAMAGES. WEIDMUELLER EXCLUSIVELY RESERVES THE RIGHT TO FILE FOR PATENTS, UTILITY MODELS OR DESIGNS.  
 © WEIDMUELLER INTERFACE GmbH & Co.KG



36	59,5	2,344	62,9	2,479	66,4	2,617	69,8	2,751
34	56,0	2,206	59,4	2,341	62,9	2,479	66,3	2,613
32	52,5	2,069	55,9	2,203	59,4	2,341	62,8	2,475
30	49,0	1,931	52,4	2,065	55,9	2,203	59,3	2,337
28	45,5	1,793	48,9	1,927	52,4	2,065	55,8	2,199
26	42,0	1,655	45,4	1,789	48,9	1,927	52,3	2,061
24	38,5	1,517	41,9	1,651	45,4	1,789	48,8	1,923
22	35,0	1,379	38,4	1,513	41,9	1,651	45,3	1,785
20	31,5	1,241	34,9	1,375	38,4	1,513	41,8	1,647
18	28,0	1,103	31,4	1,237	34,9	1,375	38,3	1,509
16	24,5	0,965	27,9	1,099	31,4	1,237	34,8	1,371
14	21,0	0,827	24,4	0,961	27,9	1,099	31,3	1,233
12	17,5	0,690	20,9	0,823	24,4	0,961	27,8	1,095
10	14,0	0,552	17,4	0,685	20,9	0,823	24,3	0,957
8	10,5	0,414	13,9	0,547	17,4	0,685	20,8	0,819
6	7,0	0,276	10,4	0,409	13,9	0,547	17,3	0,681
4	3,5	0,138	6,9	0,271	10,4	0,409	13,8	0,543
n	L1	L1[inch]	L2	L2[inch]	L3	L3[inch]	L4	L4[inch]

n = POLZAHL/NO OF POLES

P = RASTER/PITCH

SHOWN: B2L 3.50/08/180F

For the mounting of PCBs, it should be noted that the rated data given in the catalogue relates only to the connection elements. The necessary creepage and clearance paths must be observed in connection with the respective applicant in accordance to VDE 0110. The current-carrying capacity and pitch tolerance is to be determined according to DIN IEC 326 part 3 very fine.

Weidmüller connectors are tested to the DIN VDE 0627 standard, and are valid for its field of application. Provided that the components are used to the intended purpose, all requirements with respect to the occurring of electrical, mechanical, thermic and corrosive stress will be satisfied.

	DIN ISO 2768-m		CAT.NO.:	
	69611/5 25.04.13 HELIS_MA 00		C 55622 02	
MODIFICATION			DRAWING NO. OF 03 SHEETS	
		DATE	NAME	<b>B2L 3.50/.. /180...</b> BUCHSENLEISTE SOCKET BLOCK
DRAWN		16.01.2012	HELIS_MA	
RESPONSIBLE			LANG_T	
CHECKED		22.05.2013	HECKERT_M	
SCALE: 2:1		CHECKED	HECKERT_M	PRODUCT FILE: B2L 3.50
SUPERSEDES: 26643/31		APPROVED	HECKERT_M	7110