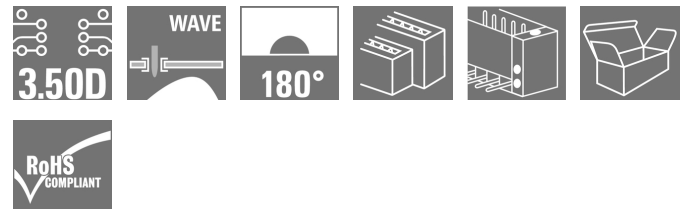

**OMNIMATE Signal - series B2L/S2L 3.50 - 2-row  
S2L 3.50/08/180F 3.5SN BK BX**

**Weidmüller Interface GmbH & Co. KG**  
Klingenbergstraße 16  
D-32758 Detmold  
Germany  
Fon: +49 5231 14-0  
Fax: +49 5231 14-292083  
www.weidmueller.com

**Product image**

Similar to illustration

Straight, double-row pin header available in closed-sided or flange version (open-sided pin headers on request). The male headers with a pin length of 3.5mm are designed for wave soldering and are packed in a box. They can be screwed on to the PCB. The male headers provide space for labelling and can be coded.

**General ordering data**

|              |  |
|--------------|--|
| Type         | S2L 3.50/08/180F 3.5SN BK BX   |
| Order No.    | <a href="#">1729600000</a>   |
| Version      | PCB plug-in connector, male header, Flange, THT solder connection, 3.50 mm, No. of poles: 8, 180°, Solder pin length (l): 3.5 mm, tinned, Black, Box |
| GTIN (EAN)   | 4032248041008  |
| Qty.         | 84 pc(s).  |
| Product data | IEC: 250 V / 10 A<br>UL: 150 V / 10 A  |
| Packaging    | Box  |

**OMNIMATE Signal - series B2L/S2L 3.50 - 2-row  
S2L 3.50/08/180F 3.5SN BK BX**

**Weidmüller Interface GmbH & Co. KG**  
Klingenbergstraße 16  
D-32758 Detmold  
Germany  
Fon: +49 5231 14-0  
Fax: +49 5231 14-292083  
www.weidmueller.com

**Technical data****Dimensions and weights**

|                          |            |                 |            |
|--------------------------|------------|-----------------|------------|
| Width                    | 21 mm      | Width (inches)  | 0.827 inch |
| Height                   | 17.7 mm    | Height (inches) | 0.697 inch |
| Height of lowest version | 14.2 mm    | Depth           | 10.5 mm    |
| Depth (inches)           | 0.413 inch | Net weight      | 3.3 g      |

**System specifications**

| Product family                                    | OMNIMATE Signal - series B2L/S2L 3.50 - 2-row | Type of connection                           | Board connection             |
|---|---|--|------------------------------|
| Mounting onto the PCB                             | THT solder connection                         | Pitch in mm (P)                              | 3.5 mm                       |
| Pitch in inches (P)                               | 0.138 inch                                    | Outgoing elbow                               | 180°                         |
| No. of poles                                      | 8   | Number of solder pins per pole               | 1                            |
| Solder pin length (l)                             | 3.5 mm  | Tolerance of solder pin position             | ± 0.1 mm                     |
| Solder pin dimensions                             | d = 1.0 mm, Octagonal                         | Solder eyelet hole diameter (D)              | 1.3 mm                       |
| Solder eyelet hole diameter tolerance (D)+ 0,1 mm |   | L1 in mm                                     | 10.5 mm                      |
| L1 in inches                                      | 0.413 inch                                    | Number of rows                               | 1                            |
| Pin series quantity                               | 2   | Touch-safe protection acc. to DIN VDE 57 106 | Safe from back-of-hand touch |
| Touch-safe protection acc. to DIN VDE 0470        | IP 10   | Can be coded                                 | Yes                          |
| Plugging cycles                                   | 25  | Plugging force/pole, max.                    | 5 N                          |
| Pulling force/pole, max.                          | 4 N   |  |                              |

**Material data**

|                                       |          |                                       |                              |
|---------------------------------------|----------|---------------------------------------|------------------------------|
| Insulating material                   | PBT      | Colour                                | Black                        |
| Colour chart (similar)                | RAL 9011 | Insulating material group             | IIIa                         |
| CTI                                   | ≥ 200    | Insulation resistance                 | ≥ 10 <sup>8</sup> Ω          |
| UL 94 flammability rating             | V-0      | Contact material                      | Copper alloy                 |
| Contact surface                       | tinned   | Layer structure of solder connection  | 2-3 μm Ni / 5-7 μm Sn glossy |
| Storage temperature, min.             | -25 °C   | Storage temperature, max.             | 55 °C                        |
| Max. relative humidity during storage | 80 %     | Operating temperature, min.           | -50 °C                       |
| Operating temperature, max.           | 100 °C   | Temperature range, installation, min. | -30 °C                       |
| Temperature range, installation, max. | 100 °C   |                                       |                              |

**Rated data acc. to IEC**

|   |                        |   |                  |
|---|------------------------|---|------------------|
| tested acc. to standard   | IEC 60664-1, IEC 61984 | Rated current, min. no. of poles (Tu=20°C)                            | 10 A             |
| Rated current, max. no. of poles (Tu=20°C)                                | 10 A                   | Rated current, min. no. of poles (Tu=40°C)                            | 9 A              |
| Rated current, max. no. of poles (Tu=40°C)                                | 8.5 A                  | Rated voltage for surge voltage class / pollution degree II/2         | 250 V            |
| Rated voltage for surge voltage class / pollution degree III/2            | 125 V                  | Rated voltage for surge voltage class / pollution degree III/3        | 80 V             |
| Rated impulse voltage for surge voltage class/ pollution degree II/2      | 2.5 kV                 | Rated impulse voltage for surge voltage class/ pollution degree III/2 | 2.5 kV           |
| Rated impulse voltage for surge voltage class/ contamination degree III/3 | 2.5 kV                 | Short-time withstand current resistance                               | 3 x 1s with 77 A |

**Data sheet**

**OMNIMATE Signal - series B2L/S2L 3.50 - 2-row  
S2L 3.50/08/180F 3.5SN BK BX**

**Weidmüller Interface GmbH & Co. KG**  
Klingenbergstraße 16  
D-32758 Detmold  
Germany  
Fon: +49 5231 14-0  
Fax: +49 5231 14-292083  
www.weidmueller.com

**Technical data**

**Rated data acc. to CSA**

|                                   |   |                                   |                |
|-----------------------------------|---|-----------------------------------|----------------|
| Institute (CSA)                   |  | Certificate No. (CSA)             | 200039-1488444 |
| Rated voltage (Use group B / CSA) | 150 V   | Rated current (Use group B / CSA) | 5 A            |
| Reference to approval values      | Specifications are maximum values, details - see approval certificate.            |                                   |                |

**Rated data acc. to UL 1059**

|                                       |   |                                       |        |
|---------------------------------------|---|---------------------------------------|--------|
| Institute (UR)                        |  | Certificate No. (UR)                  | E60693 |
| Rated voltage (Use group B / UL 1059) | 150 V   | Rated voltage (Use group C / UL 1059) | 50 V   |
| Rated current (Use group B / UL 1059) | 10 A  | Rated current (Use group C / UL 1059) | 10 A   |
| Reference to approval values          | Specifications are maximum values, details - see approval certificate.            |                                       |        |

**Packaging**

|           |        |            |        |
|-----------|--------|------------|--------|
| Packaging | Box    | VPE length | 25 mm  |
| VPE width | 135 mm | VPE height | 350 mm |

**Classifications**

|            |             |            |             |
|------------|-------------|------------|-------------|
| ETIM 4.0   | EC002637    | ETIM 5.0   | EC002637    |
| ETIM 6.0   | EC002637    | UNSPSC     | 30-21-18-10 |
| eClass 5.1 | 27-26-07-01 | eClass 6.2 | 27-26-07-04 |
| eClass 7.1 | 27-44-04-02 | eClass 8.1 | 27-44-04-02 |
| eClass 9.0 | 27-44-04-02 | eClass 9.1 | 27-44-04-02 |

**Notes**

|       |  |
|-------|--|
| Notes | <ul style="list-style-type: none"> <li>• Additional colours on request</li> <li>• Gold-plated contact surfaces on request</li> <li>• Spacing between rows: see hole layout</li> <li>• Rated current related to rated cross-section &amp; min. No. of poles.</li> <li>• P on drawing = pitch</li> <li>• Rated data refer only to the component itself. Clearance and creepage distances to other components are to be designed in accordance with the relevant application standards.</li> <li>• For additional mechanical support for male connectors with screw flange (...F), we recommend an additional cable gland with fastening screws (sheet metal screw ISO 1481-ST 2.2x4.5 C or ISO 7049-ST 2.2x4.5 C - see Accessories). Cable gland only permitted before soldering.</li> </ul> |
|-------|--|

|                |  |
|----------------|--|
| IPC conformity | Conformity: The products are developed, manufactured and delivered according international recognized standards and norms and comply with the assured properties in the data sheet resp. fulfill decorative properties in accordance with IPC-A-610 "Class 2". Further claims on the products can be evaluated on request. |
|----------------|--|

Creation date January 16, 2019 1:21:06 PM CET

**Data sheet****OMNIMATE Signal - series B2L/S2L 3.50 - 2-row  
S2L 3.50/08/180F 3.5SN BK BX**

**Weidmüller Interface GmbH & Co. KG**  
Klingenbergstraße 16  
D-32758 Detmold  
Germany  
Fon: +49 5231 14-0  
Fax: +49 5231 14-292083  
www.weidmueller.com

**Technical data****Approvals**

Approvals



ROHS

Conform

**Downloads**Approval/Certificate/Document of  
Conformity[Declaration of the Manufacturer](#)

Brochure/Catalogue

[FL DRIVES EN](#)  
[MB DEVICE MANUF. EN](#)  
[FL DRIVES DE](#)  
[CAT 2 PORTFOLIOGUIDE EN](#)  
[FL BUILDING SAFETY EN](#)  
[FL APPL LED LIGHTING EN](#)  
[FLIndustr.CONTROLS EN](#)  
[FL MACHINE SAFETY EN](#)  
[FL HEATING ELECTR EN](#)  
[FL APPL INVERTER EN](#)  
[FL\\_BASE\\_STATION\\_EN](#)  
[FL ELEVATOR EN](#)  
[FL POWER SUPPLY EN](#)  
[FL 72H SAMPLE SER EN](#)  
[PO OMNIMATE EN](#)

Engineering Data

[S2L-SMT.zip](#)  
[STEP](#)

**Data sheet**

**OMNIMATE Signal - series B2L/S2L 3.50 - 2-row  
S2L 3.50/08/180F 3.5SN BK BX**

**Weidmüller Interface GmbH & Co. KG**  
 Klingenbergstraße 16  
 D-32758 Detmold  
 Germany  
 Fon: +49 5231 14-0  
 Fax: +49 5231 14-292083  
 www.weidmueller.com

**Drawings**

**Dimensional drawing**

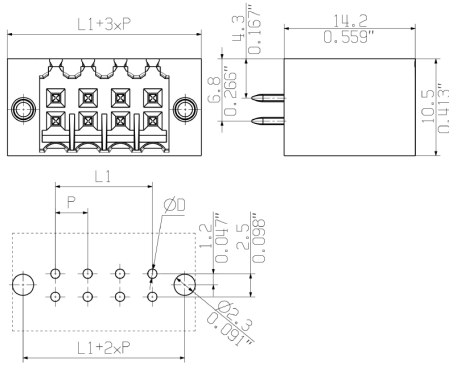

The reproduction, distribution and utilization of this document as well as the communication of its contents to others without explicit authorization is prohibited. Offenders will be held liable for the payment of damages. Weidmüller exclusively reserves the right to file for patents, utility models or designs.

© Weidmüller Interface GmbH & Co. KG

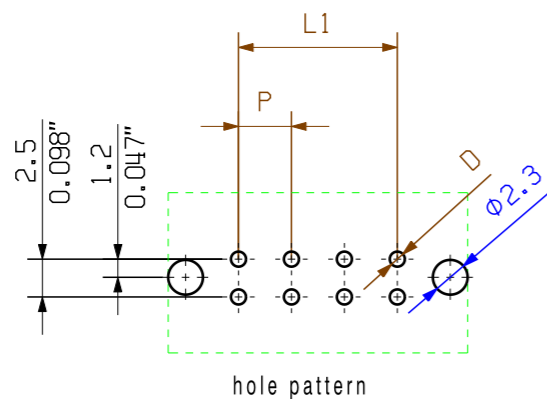
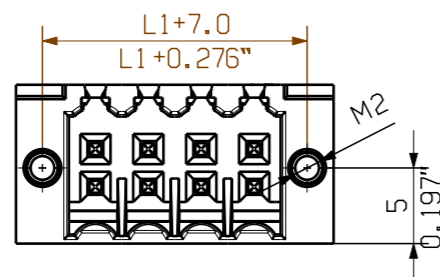
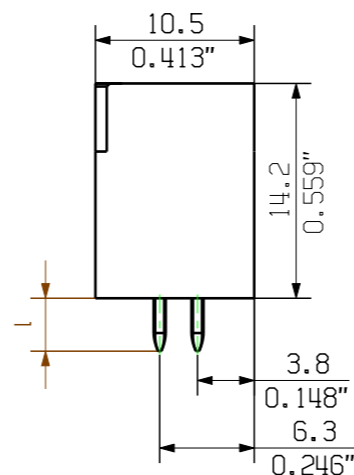
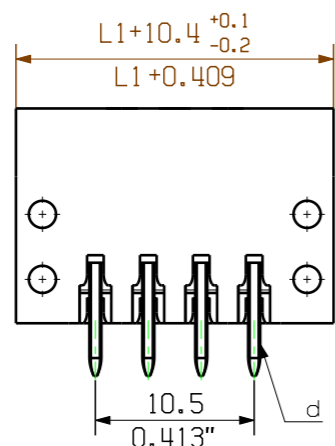

hole pattern

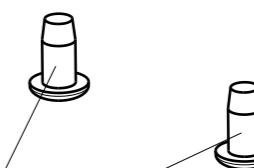
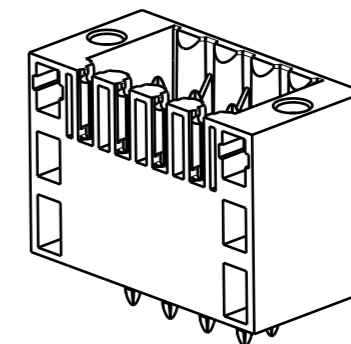

optional fixing screw  
order no.: 161074 0000

|    |                         |         |                              |
|----|-------------------------|---------|------------------------------|
| 46 | 77.0                    | +/-0.2  |                              |
| 44 | 73.5                    |         |                              |
| 42 | 70.0                    |         |                              |
| 40 | 66.5                    |         |                              |
| 38 | 63.0                    |         |                              |
| 36 | 59.5                    |         |                              |
| 34 | 56.0                    | +/-0.15 |                              |
| 32 | 52.5                    |         |                              |
| 30 | 49.0                    |         |                              |
| 28 | 45.5                    |         |                              |
| 26 | 42.0                    | +/-0.1  |                              |
| 24 | 38.5                    |         |                              |
| 22 | 35.0                    |         |                              |
| 20 | 31.5                    |         |                              |
| 18 | 28.0                    |         |                              |
| 16 | 24.5                    |         |                              |
| 14 | 21.0                    |         |                              |
| 12 | 17.5                    |         |                              |
| 10 | 14.0                    |         |                              |
| 8  | 10.5                    |         |                              |
| 6  | 7.0                     |         |                              |
| 4  | 3.5                     |         |                              |
| n  | Polzahl/<br>no of poles | L1      | Toleranz/<br>tolerance<br>L1 |

P = 3.50 Raster Pitch

D = Ø1,3<sup>+0.1</sup>  
Ø0.051<sup>+0.1</sup>

d = 1mm oktogonal  
0.039" oktogonal

shown S2L 3.50/././180F

| pin length<br>l | tolerance   |
|-----------------|-------------|
| 3,5             | 0,2<br>-0,2 |
| 2,6             | 0,2<br>-0,2 |

For the mounting of PCBs, it should be noted that the rated data given in the catalogue relates only to the connection elements. The necessary creepage and clearance paths must be observed in connection with the respective applicant in accordance with VDE 0110. The current-carrying capacity and pitch tolerance is to be determined according to DIN IEC 326 part 3 very fine.

Weidmüller connectors are tested to the DIN VDE 0627 standard, and are valid for its field of application. Provided that the connectors are used to the intended purpose, all requirements with respect to the occurring of electrical, mechanical, thermic and corrosive stress will be satisfied.

|                                       |             |                                 |                        |            |   |
|---------------------------------------|-------------|---------------------------------|------------------------|------------|---|
| General tolerance:<br>DIN ISO 2768-mK |             | 98746/5<br>29.11.17 HELIS_MA 01 |                        | Cat.no.: . |   |
|                                       |             | Modification                    |                        |            |   |
|                                       |             | Drawn                           | Date                   | Name       | <b>3 25607 18</b><br>Drawing no. Issue no.            |
| Scale: 5/1                            | Responsible | Checked                         | Date                   | Name       | <b>S2L 3.50/././...</b><br>STIFTLAISTE<br>MALE HEADER |
| Supersedes: .                         | Approved    | LANG_T                          | Product file: S2L 3.50 | 7110       |   |

Sheet 06 of 06 sheets

## Recommended wave soldering profiles

**Weidmüller Interface GmbH & Co. KG**  
 Klingenbergstraße 16  
 D-32758 Detmold  
 Germany  
 Fon: +49 5231 14-0  
 Fax: +49 5231 14-292083  
 www.weidmueller.com

### Single Wave:



### Double Wave:



### Wave soldering profiles

Wired connection elements should be processed in accordance with the DIN EN 61760-1 standard. We have included two recommendations for practical wave soldering profiles, with which Weidmüller PCB terminals and connectors are qualified.

When choosing a suitable profile for your application, the following factors also need to be considered:

- PCB thickness
- Proportion of Cu in the layers
- Single/double-sided assembly
- Product range
- Heating and cooling rates

The single and double wave profiles each indicate the recommended operating range, including the maximum soldering temperature of 260°C. In practice, the maximum soldering temperature is quite often well below the above maximum profile.