

## OMNIMATE Signal - series LM LM2N 3.50/32/90 3.2SN OR BX

**Weidmüller Interface GmbH & Co. KG**  
Klingenbergstraße 16  
D-32758 Detmold  
Germany  
Fon: +49 5231 14-0  
Fax: +49 5231 14-292083  
www.weidmueller.com

### Product image



Similar to illustration

Small, compact PCB terminal or -tier PCB terminal with proven clamping yoke connection and 3.5 mm pitch. Suitable for conductor cross-sections up to 1.5 mm<sup>2</sup>.

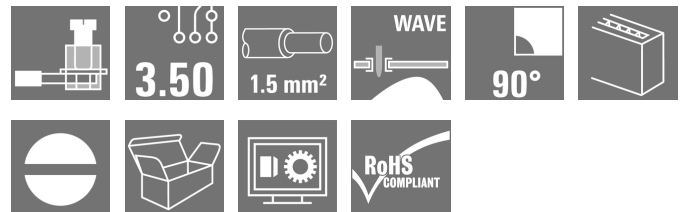

### General ordering data

Type	LM2N 3.50/32/90 3.2SN OR BX
Order No.	<a href="#">1703840000</a>
Version	PCB terminal, 3.50 mm, No. of poles: 32, 90°, Solder pin length (l): 3.2 mm, tinned, Orange, Clamping yoke connection, Clamping range, max.: 2.08 mm <sup>2</sup> , Box
GTIN (EAN)	4008190910914
Qty.	25 pc(s).
Product data	IEC: 320 V / 13 A / 0.5 - 1.5 mm <sup>2</sup> UL: 300 V / 10 A / AWG 28 - AWG 14
Packaging	Box

**OMNIMATE Signal - series LM  
LM2N 3.50/32/90 3.2SN OR BX**

**Weidmüller Interface GmbH & Co. KG**  
 Klingenbergstraße 16  
 D-32758 Detmold  
 Germany  
 Fon: +49 5231 14-0  
 Fax: +49 5231 14-292083  
 www.weidmueller.com

**Technical data****Dimensions and weights**

Width	58.35 mm	Width (inches)	2.297 inch
Height	27.3 mm	Height (inches)	1.075 inch
Height of lowest version	24.1 mm	Depth	16.75 mm
Depth (inches)	0.659 inch	Net weight	25.12 g

**System parameters**

Product family	OMNIMATE Signal - series LM	Wire connection method	Clamping yoke connection
Mounting onto the PCB	THT solder connection	Conductor outlet direction	90°
Pitch in mm (P)	3.5 mm	Pitch in inches (P)	0.138 inch
No. of poles	32	Fitted by customer	Yes
Max. adjacent poles per row	24	Solder pin length (l)	3.2 mm
Solder pin dimensions	1.0 x 0.6 mm	Solder eyelet hole diameter (D)	1.3 mm
Solder eyelet hole diameter tolerance (D)+	0, 1 mm	Number of solder pins per pole	1
Screwdriver blade	0.4 x 2.5	Screwdriver blade standard	DIN 5264
Tightening torque, min.	0.2 Nm	Tightening torque, max.	0.2 Nm
Clamping screw	M 2	Stripping length	5 mm
L1 in mm	52.5 mm	L1 in inches	2.067 inch
Touch-safe protection acc. to DIN VDE 0470	IP 20	Touch-safe protection acc. to DIN VDE 57 106	Safe from finger touch
Volume resistance	3.60 mΩ		

**Material data**

Insulating material	PA	Colour	Orange
Colour chart (similar)	RAL 2000	Insulating material group	I
CTI	≥ 600	Insulation resistance	≥ 10 <sup>8</sup> Ω
UL 94 flammability rating	V-2	Contact material	Copper alloy
Contact surface	tinned	Coating	1-3 μm Ni, 4-6 μm SN
Tinning type	matt	Layer structure of solder connection	1.5-3 μm Ni / 4-6 μm Sn matt
Storage temperature, min.	-25 °C	Storage temperature, max.	55 °C
Max. relative humidity during storage	80 %	Operating temperature, min.	-50 °C
Operating temperature, max.	100 °C	Temperature range, installation, min.	-25 °C
Temperature range, installation, max.	100 °C		

**Conductors suitable for connection**

Clamping range, min.	0.08 mm <sup>2</sup>	Clamping range, max.	2.08 mm <sup>2</sup>
Wire connection cross section AWG, min.	AWG 28	Wire connection cross section AWG, max.	AWG 14
Solid, min. H05(07) V-U	0.5 mm <sup>2</sup>	Solid, max. H05(07) V-U	1.5 mm <sup>2</sup>
Flexible, min. H05(07) V-K	0.5 mm <sup>2</sup>	Flexible, max. H05(07) V-K	1.5 mm <sup>2</sup>
w. plastic collar ferrule, DIN 46228 pt 4, min.	0.5 mm <sup>2</sup>	w. plastic collar ferrule, DIN 46228 pt 4, max.	0.75 mm <sup>2</sup>
Plug gauge in accordance with EN 60999 a x b; ø	2.4 mm x 1.5 mm		

**OMNIMATE Signal - series LM  
LM2N 3.50/32/90 3.2SN OR BX**

**Weidmüller Interface GmbH & Co. KG**  
 Klingenbergstraße 16  
 D-32758 Detmold  
 Germany  
 Fon: +49 5231 14-0  
 Fax: +49 5231 14-292083  
 www.weidmueller.com

**Technical data****Rated data acc. to IEC**

tested acc. to standard	IEC 60664-1, IEC 61984	Rated current, min. no. of poles (Tu=20°C)	13 A
Rated current, max. no. of poles (Tu=20°C)	12 A	Rated current, min. no. of poles (Tu=40°C)	11 A
Rated current, max. no. of poles (Tu=40°C)	10 A	Rated voltage for surge voltage class / pollution degree II/2	320 V
Rated voltage for surge voltage class / pollution degree III/2	160 V	Rated voltage for surge voltage class / pollution degree III/3	160 V
Rated impulse voltage for surge voltage class/ pollution degree II/2	2.5 kV	Rated impulse voltage for surge voltage class/ pollution degree III/2	2.5 kV
Rated impulse voltage for surge voltage class/ contamination degree III/3	2.5 kV	Short-time withstand current resistance	3 x 1s with 72 A

**Rated data acc. to CSA**

Institute (CSA)		Certificate No. (CSA)	154685-1202192
Rated voltage (Use group B / CSA)	300 V	Rated voltage (Use group D / CSA)	300 V
Rated current (Use group B / CSA)	10 A	Rated current (Use group D / CSA)	10 A
Wire cross-section, AWG, min.	AWG 28	Wire cross-section, AWG, max.	AWG 14
Reference to approval values	Specifications are maximum values, details - see approval certificate.		

**Rated data acc. to UL 1059**

Institute (UR)		Certificate No. (UR)	E60693
Rated voltage (Use group B / UL 1059)	300 V	Rated voltage (Use group D / UL 1059)	300 V
Rated current (Use group B / UL 1059)	10 A	Rated current (Use group D / UL 1059)	10 A
Wire cross-section, AWG, min.	AWG 28	Wire cross-section, AWG, max.	AWG 14
Reference to approval values	Specifications are maximum values, details - see approval certificate.		

**Packaging**

Packaging	Box	VPE length	30 mm
VPE width	135 mm	VPE height	195 mm

**Classifications**

ETIM 3.0	EC001284	ETIM 4.0	EC002643
ETIM 5.0	EC002643	ETIM 6.0	EC002643
UNSPSC	30-21-18-01	eClass 6.2	27-26-11-01
eClass 7.1	27-44-04-01	eClass 8.1	27-44-04-01
eClass 9.0	27-44-04-01	eClass 9.1	27-44-04-01

**Data sheet**

**OMNIMATE Signal - series LM  
LM2N 3.50/32/90 3.2SN OR BX**

**Weidmüller Interface GmbH & Co. KG**  
Klingenbergstraße 16  
D-32758 Detmold  
Germany  
Fon: +49 5231 14-0  
Fax: +49 5231 14-292083  
www.weidmueller.com

**Technical data**

**Notes**

- |       |  |
|-------|--|
| Notes | <ul style="list-style-type: none"> <li>• Additional colours on request</li> <br/> <li>• Rated current related to rated cross-section &amp; min. No. of poles.</li> <br/> <li>• Max. outer diameter of the conductor: 2.9 mm</li> <br/> <li>• Wire end ferrule with plastic collar to DIN 46228/4</li> <br/> <li>• P on drawing = pitch</li> <br/> <li>• Rated data refer only to the component itself. Clearance and creepage distances to other components are to be designed in accordance with the relevant application standards.</li> </ul> |
|-------|--|

IPC conformity	Conformity: The products are developed, manufactured and delivered according international recognized standards and norms and comply with the assured properties in the data sheet resp. fulfill decorative properties in accordance with IPC-A-610 "Class 2". Further claims on the products can be evaluated on request.
----------------	--

**Approvals**

Approvals



ROHS	Conform
------	---------

**Downloads**

Approval/Certificate/Document of Conformity	<a href="#">Declaration of the Manufacturer</a>
Brochure/Catalogue	<a href="#">FL DRIVES EN</a> <a href="#">FL ANALO.SIGN.CONV. EN</a> <a href="#">MB DEVICE MANUF. EN</a> <a href="#">FL DRIVES DE</a> <a href="#">CAT 2 PORTFOLIOGUIDE EN</a> <a href="#">FL BUILDING SAFETY EN</a> <a href="#">FL APPL LED LIGHTING EN</a> <a href="#">FLIndustr.CONTROLS EN</a> <a href="#">FL MACHINE SAFETY EN</a> <a href="#">FL HEATING ELECTR EN</a> <a href="#">FL APPL INVERTER EN</a> <a href="#">FL_BASE_STATION EN</a> <a href="#">FL ELEVATOR EN</a> <a href="#">FL POWER SUPPLY EN</a> <a href="#">FL 72H SAMPLE SER EN</a> <a href="#">PO OMNIMATE EN</a>
Engineering Data	<a href="#">EPLAN_WSCAD</a>
Engineering Data	<a href="#">LM2N.zip</a>

**OMNIMATE Signal - series LM  
LM2N 3.50/32/90 3.2SN OR BX**

**Weidmüller Interface GmbH & Co. KG**  
 Klingenbergstraße 16  
 D-32758 Detmold  
 Germany  
 Fon: +49 5231 14-0  
 Fax: +49 5231 14-292083  
 www.weidmueller.com

**Drawings**

**Dimensional drawing**

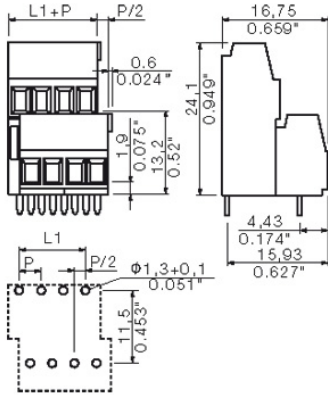

**Graph**

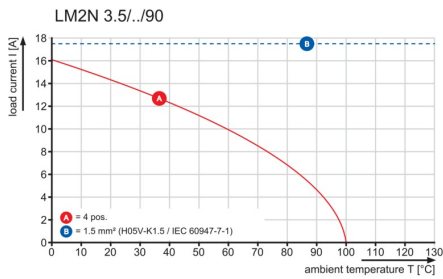

## Technical Data

Rev.

### Material data

Insulation material type	PA 66
Insulation material colours	orange/black
Insulation material flammability class	UL94 V - 2
Insulation resistance	MOhm 10 <sup>3</sup>
Contact base material	Cu-alloy
Contact plating	tin-plated

### System characteristic values

Pitch P	mm/inch	3.5/0.138
Number of rows		2
Dielectric strength (r.m.s withstand voltage)	kV	>1.5
Through resistance (typical)	mOhm	2.2
Operating temperature range	°C	-55°...+100° 1)
Degree of protection acc. to VDE 0106		finger safe
Degree of protection acc. to DIN EN 60529		IP20
Conductor connection method		clamping yoke
Screw size		M2
Screw torque max. acc. to EN 60999	Nm	0.2
Screw driver type		SDI 0.4x2.5
Solder pin length L	mm/inch	3.2/0.126
PCB hole diameter D (wave soldering)	mm/inch	1.3+0.1/0.051+0.004 2)
PCB hole diameter D (reflow soldering)	mm/inch	n.a. 3)
Resistance to soldering heat acc. to DIN IEC 60512-6	°C/sec	260/10 4)
Resistance to soldering heat acc. to EN 61760-1	°C/sec	n.a. 5)
Solderability classification acc. to EN 61760-1		n.a.
Solder connection type		wave soldering
Solder pin diameter d (max.)	mm/inch	1.22/0.048

### Application notes

Coding possibility	yes/no	no
Joinable without loss of pitch	yes/no	no
Manual assembly of modules	yes/no	yes
Max. number of poles	n	48

### Conductor

Clamping range	mm <sup>2</sup>	0.08...1.5
"e" solid H05(07) V-U	mm <sup>2</sup>	0.08...1.5
"f" flexible H05(07) V-K	mm <sup>2</sup>	0.08...1.5
"f" with ferrule acc. to DIN 46228/1	mm <sup>2</sup>	n.a.
... with plastic collar acc. to DIN 46228/4	mm <sup>2</sup>	n.a.
Conductor insulation stripping length	mm/inch	5/0.197
Conductor insulation diameter max.	mm/inch	n.a.
Two wire clamping range	mm <sup>2</sup>	0.5
Gauge to EN 60999 (a x b ; Ø)	mm	2.4x1.5

### IEC 664-1 / VDE0110 (4.97) rated data

Rated cross section acc. to EN 60999	mm <sup>2</sup>	1.5
Rated current @ 20°C ambient	A	10 6)
Rated current @ 40°C ambient	A	8.5 6)

### Overvoltage category / Pollution degree

Rated voltage	V	III/3	III/2	II/2
Rated impulse voltage	kV	160	160	320
		2.5	2.5	2.5

### UL 1059 rated data

 File No.: E60693

Rated voltage	B	C	D
	300	---	300
Rated current	10	---	10
AWG wire range (field wiring / factory wiring)	28...14		

### CSA C22.2 rated data

 File No.: LR12400

Rated voltage	B	C	D
	300	---	300
Rated current	10	---	10
AWG wire range (field wiring / factory wiring)	28...14		

### Packaging

carton

### Downloads

www.weidmueller.de

- 1) Sum of ambient temperature and temperature rise
- 2) Recommendation for manual assembly
- 3) Recommendation for automatic assembly
- 4) Recommendation for wave soldering
- 5) Recommendation for reflow soldering
- 6) Referred to rated cross section and 12 pole number

n.a. = not applicable

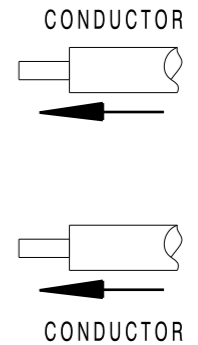
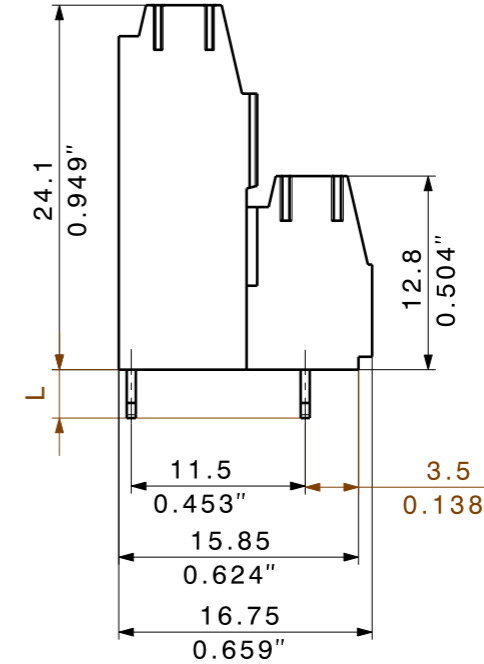
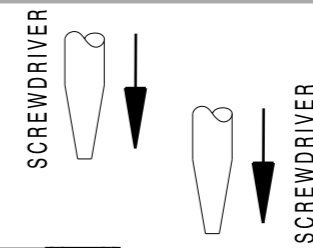
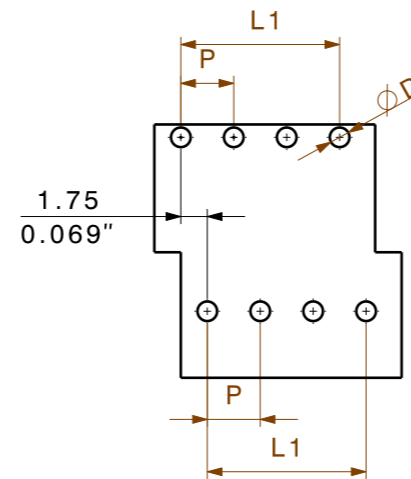
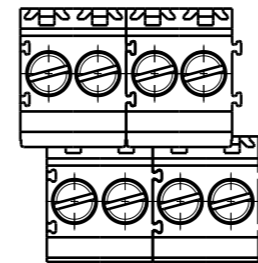
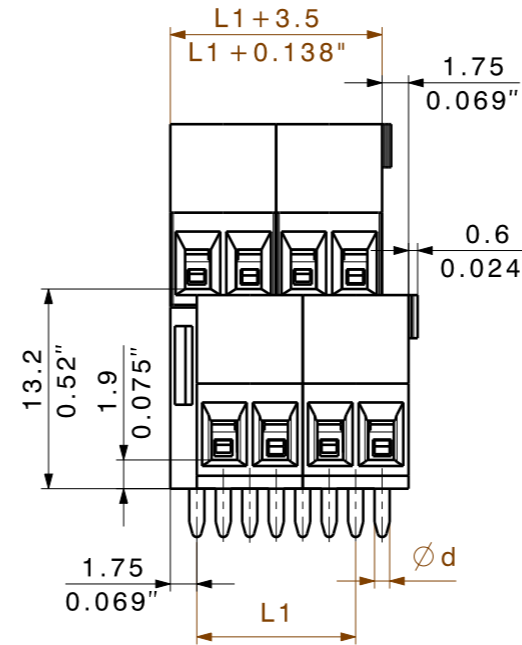

Subject to technical changes



DIE DEUTSCHE VERSION IST VERBINDLICH  
THE GERMAN VERSION IS BINDING

48	80,50	3,169
46	77,00	3,031
44	73,50	2,894
42	70,00	2,756
40	66,50	2,618
38	63,00	2,480
36	59,50	2,343
34	56,00	2,205
32	52,50	2,067
30	49,00	1,929
28	45,50	1,791
26	42,00	1,654
24	38,50	1,516
22	35,00	1,378
20	31,50	1,240
18	28,00	1,102
16	24,50	0,965
14	21,00	0,827
12	17,50	0,689
10	14,00	0,551
8	10,50	0,413
6	7,00	0,276
4	3,50	0,138
n	L1 [mm]	L1 [inch]

SHOWN LM2N3.5/8/90

 METRIC TOLERANCES X. = ±0.3 X.X = ±0.1 X.XX = ±0.05	43264/5 17.06.09 HELIS_MA 00		CAT.NO.: <b>C 23209 08</b>	
	MODIFICATION		DRAWING NO. ISSUE NO. SHEET 02 OF 03 SHEETS	
	DATE	NAME	<b>LM2N 3.5/././90</b> LEITERPLATTENANSCHLUSSKLEMME PCB TERMINAL PRODUCT FILE: LM1N 3.5 1111	
	DRAWN	23.09.2008		
RESPONSIBLE		KRUG_M		
CHECKED	18.06.2009	HECKERT_M		
APPROVED		HECKERT_M		

For the mounting of PCBs, it should be noted that the rated data stated here relates only to the PCB components alone.  
The necessary creepage and clearance paths must be observed in connection with the respective applicant in accordance to IEC 664 / VDE 0110.  
The current-carrying capacity and pitch tolerance is to be determined according to DIN IEC 326 part 3 very fine.

Weidmüller PCB components are tested to the DIN EN 61984 standard, and are valid for its field of application. Provided that the components are used to the intended purpose, all requirements with respect to the occurring of electrical, mechanical, thermic and corrosive stress will be satisfied.

WEIDMÜLLER INTERFACE GmbH & Co. KG  
 WEITERGABE SOWIE VERVIELFÄLTIGUNG DIESES DOKUMENTS, VERWERTUNG UND MITTEILUNG SEINES INHALTS SIND VERBOTEN, SOWEIT NICHT AUSDRUECKLICH GESTATTET.  
 ZUWIDERHANDLUNGEN VERPFLICHTEN ZU SCHADENERSATZ. ALLE RECHTE FUER DEN FALL DER PATENT-, GEBRAUCHSMUSTER-, ODER GESCHMACKSMUSTERREINTRAGUNG VORBEHALTEN.  
 THE REPRODUCTION, DISTRIBUTION AND UTILIZATION OF THIS DOCUMENT AS WELL AS THE COMMUNICATION OF ITS CONTENTS TO OTHERS WITHOUT EXPLICIT AUTHORIZATION IS PROHIBITED.  
 OFFENDERS WILL BE HELD LIABLE FOR THE PAYMENT OF DAMAGES. WEIDMÜLLER EXCLUSIVELY RESERVES THE RIGHT TO FILE FOR PATENTS, UTILITY MODELS OR DESIGNS.

## Recommended wave soldering profiles

**Weidmüller Interface GmbH & Co. KG**  
 Klingenbergstraße 16  
 D-32758 Detmold  
 Germany  
 Fon: +49 5231 14-0  
 Fax: +49 5231 14-292083  
 www.weidmueller.com

### Single Wave:



### Double Wave:



### Wave soldering profiles

Wired connection elements should be processed in accordance with the DIN EN 61760-1 standard. We have included two recommendations for practical wave soldering profiles, with which Weidmüller PCB terminals and connectors are qualified.

When choosing a suitable profile for your application, the following factors also need to be considered:

- PCB thickness
- Proportion of Cu in the layers
- Single/double-sided assembly
- Product range
- Heating and cooling rates

The single and double wave profiles each indicate the recommended operating range, including the maximum soldering temperature of 260°C. In practice, the maximum soldering temperature is quite often well below the above maximum profile.