

## OMNIMATE Signal - series BL/SL 3.50 BL 3.50/18/270 SN BK BX

**Weidmüller Interface GmbH & Co. KG**  
Klingenbergstraße 16  
D-32758 Detmold  
Germany  
Fon: +49 5231 14-0  
Fax: +49 5231 14-292083  
www.weidmueller.com

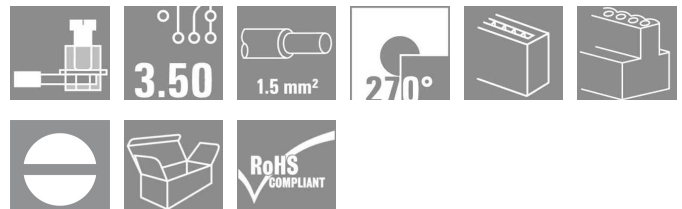

Female connectors with clamping yoke screw system for connecting conductors at 3.50 mm pitch. They include space for labelling and can be coded.

- 0.20 - 1.5 mm<sup>2</sup> (IEC) / 28 - 14 AWG (UL)
- 250 V (IEC) / 300 V (UL)
- 17 A (IEC) / 10 A (UL)

### General ordering data

Available until	2014-05-20
Type	BL 3.50/18/270 SN BK BX
Order No.	<a href="#">1639860000</a>
Version	PCB plug-in connector, female plug, 3.50 mm, No. of poles: 18, 270°, Clamping yoke connection, Clamping range, rated connection, max.: 1.5 mm <sup>2</sup> , Box
GTIN (EAN)	4008190277413
Qty.	20 pc(s).
Product data	IEC: 320 V / 12 A / 0.2 - 1.5 mm <sup>2</sup> UL: 300 V / 8 A / AWG 28 - AWG 14
Packaging	Box

**OMNIMATE Signal - series BL/SL 3.50**  
**BL 3.50/18/270 SN BK BX**

**Weidmüller Interface GmbH & Co. KG**  
 Klingenbergstraße 16  
 D-32758 Detmold  
 Germany  
 Fon: +49 5231 14-0  
 Fax: +49 5231 14-292083  
 www.weidmueller.com

**Technical data**
**Dimensions and weights**

Net weight 17.1 g

**System parameters**

Product family	OMNIMATE Signal - series BL/SL 3.50	Wire connection method	Clamping yoke connection
Conductor outlet direction	270°	Pitch in mm (P)	3.5 mm
Pitch in inches (P)	0.138 inch	No. of poles	18
Screwdriver blade	0.4 x 2.5	Screwdriver blade standard	DIN 5264
Tightening torque, min.	0.2 Nm	Tightening torque, max.	0.25 Nm
Clamping screw	M 2	Stripping length	6 mm
L1 in mm	59.5 mm	L1 in inches	2.343 inch
Touch-safe protection acc. to DIN VDE 0470	IP 20	Touch-safe protection acc. to DIN VDE 57 106	Safe from finger touch

**Material data**

Insulating material	PBT	Colour	Black
Colour chart (similar)	RAL 9011	UL 94 flammability rating	V-0
CTI	≥ 200	Contact material	Cu-Leg
Contact surface	tinned	Operating temperature, min.	-50 °C
Operating temperature, max.	100 °C	Temperature range, installation, min.	-30 °C
Temperature range, installation, max.	100 °C		

**Connectable conductors**

Clamping range, rated connection, min.	0.08 mm <sup>2</sup>	Clamping range, rated connection, max.	1.5 mm <sup>2</sup>
Wire connection cross section AWG, min.	AWG 28	Wire connection cross section AWG, max.	AWG 14
Solid, min. H05(07) V-U	0.2 mm <sup>2</sup>	Solid, max. H05(07) V-U	1.5 mm <sup>2</sup>
Flexible, min. H05(07) V-K	0.2 mm <sup>2</sup>	Flexible, max. H05(07) V-K	1.5 mm <sup>2</sup>
w. wire end ferrule, DIN 46228 pt 1, min.	0.2 mm <sup>2</sup>	w. wire end ferrule, DIN 46228 pt 1, max.	1.5 mm <sup>2</sup>
w. plastic collar ferrule, DIN 46228 pt 4, min.	0.2 mm <sup>2</sup>	w. plastic collar ferrule, DIN 46228 pt 4, max.	1.5 mm <sup>2</sup>
Plug gauge acc. to EN 60999 a x b; Ø	2.4 mm x 1.5 mm		

**Rating data acc. to IEC 60664-1 / IEC 61984**

Rated current, min. no. of poles (Tu=20°C)	12 A	Rated current, max. no. of poles (Tu=20°C)	10 A
Rated current, number of poles (Tu=40°C), min	10 A	Rated current, number of poles (Tu=40°C), max.	8 A
Rated voltage for surge voltage class / pollution degree II/2	320 V	Rated voltage for surge voltage class / pollution degree III/2	160 V
Rated voltage for surge voltage class / pollution degree III/3	160 V	Rated impulse voltage for surge voltage class/ pollution degree II/2	2.5 kV
Rated impulse voltage for surge voltage class/ pollution degree III/2	2.5 kV	Rated impulse voltage for surge voltage class/ contamination degree III/3	2.5 kV
Short-time withstand current resistance	3 x 1s with 100 A		

**Data sheet**

**OMNIMATE Signal - series BL/SL 3.50  
BL 3.50/18/270 SN BK BX**

**Weidmüller Interface GmbH & Co. KG**  
Klingenbergstraße 16  
D-32758 Detmold  
Germany  
Fon: +49 5231 14-0  
Fax: +49 5231 14-292083  
www.weidmueller.com

**Technical data**

**CSA rating data**

Institute (CSA)		Certificate No. (CSA)	
		154685-1318353	
Rated voltage (Use group B)	300 V	Rated current (use group B)	10 A
Rated voltage (use group D)	300 V	Rated current (use group D)	10 A
Wire cross-section, AWG, min.	AWG 28	Wire cross-section, AWG, max.	AWG 14

**UL 1059 rating data**

Institute (UR)		Certificate No. (UR)	
		E60693	
Rated voltage (use group B)	300 V	Rated current (use group B)	8 A
Rated voltage (use group D)	300 V	Rated current (use group D)	8 A
Wire cross-section, AWG, min.	AWG 28	Wire cross-section, AWG, max.	AWG 14

**Classifications**

ETIM 3.0	EC001284	UNSPSC	30-21-18-10
eClass 5.1	27-26-07-04	eClass 6.2	27-26-07-04
eClass 7.1	27-44-04-02		

**Notes**

- Notes
- Additional colours on request
  - Gold-plated contact surfaces on request
  - Rated current related to rated cross-section & min. No. of poles.
  - Max. outer diameter of the conductor: 2.9 mm
  - Wire end ferrule without plastic collar to DIN 46228/1
  - Wire end ferrule with plastic collar to DIN 46228/4
  - P on drawing = pitch
  - Rated data refer only to the component itself. Clearance and creepage distances to other components are to be designed in accordance with the relevant application standards.

**Approvals**

Approvals	
ROHS	Conform

**Data sheet**

**OMNIMATE Signal - series BL/SL 3.50  
BL 3.50/18/270 SN BK BX**

**Weidmüller Interface GmbH & Co. KG**  
 Klingenbergstraße 16  
 D-32758 Detmold  
 Germany  
 Fon: +49 5231 14-0  
 Fax: +49 5231 14-292083  
 www.weidmueller.com

**Drawings**

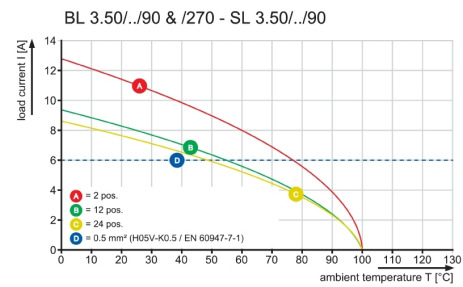
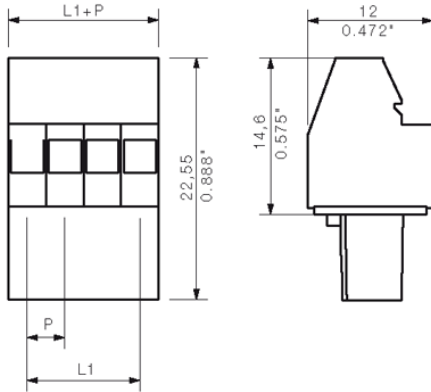

**OMNIMATE Signal - series BL/SL 3.50  
BL 3.50/18/270 SN BK BX**

**Weidmüller Interface GmbH & Co. KG**  
Klingenbergstraße 16  
D-32758 Detmold  
Germany  
Fon: +49 5231 14-0  
Fax: +49 5231 14-292083  
www.weidmueller.com

**Mating connector (conditionally pluggable)**
**SL-SMT 3.5/180G Box**

**High-temperature-resistant male header, 3.50 mm pitch.**

- **Plugging direction parallel (90°), straight 180° or angled (135°) to PCB**
- **Housing variants: closed side (G), screw flange (F), solder flange (LF) or snap-on solder flange (RF)**
- **Optimised for the SMT process**
- **Pin length 3.2 mm universal for all soldering methods**
- **Pin length 1.5 mm optimised for reflow soldering methods**
- **Packed either in a box (BX) or tape-on-reel (RL)**
- **Male header can be coded**

**General ordering data**

Type	Order No.	Version	GTIN (EAN)	Qty.	Product data	Packaging
SL-SMT 3.50/18/180G 1.5SN BK BX	<a href="#">1753142001</a>	PCB plug-in connector, male header, closed side, Reflow solder connection, 3.50 mm, No. of poles: 18, 180°, Solder pin length (l): 1.5 mm, tinned, Black, Box	4032248131044	20 pc(s).	IEC: 320 V / 15 A UL: 300 V / 10 A	Box
SL-SMT 3.50/18/180G 3.2SN BK BX	<a href="#">1842470000</a>	PCB plug-in connector, male header, closed side, Reflow solder connection, 3.50 mm, No. of poles: 18, 180°, Solder pin length (l): 3.2 mm, tinned, Black, Box	4032248353828	20 pc(s).	IEC: 320 V / 15 A UL: 300 V / 10 A	Box

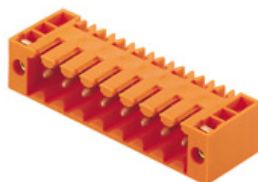
**SL 3.50/90F**

Male header with 3.50 mm pitch for wave soldering

- **Plugging direction angled to the PCB (135°)**
- **Housing variant: screw flange (F)**
- **Packaged in cardboard box (BX)**
- **Male header can be coded**

250 V (IEC) / 300 V (UL)  
17 A (IEC) / 10 A (UL)

**General ordering data**

Type	Order No.	Version	GTIN (EAN)	Qty.	Product data	Packaging
SL 3.50/18/90F 3.2SN OR BX	<a href="#">1619780000</a>	PCB plug-in connector, male header, Flange, Solder connection, 3.50 mm, No. of poles: 18, 90°, Solder pin	4008190147471	20 pc(s).	IEC: 320 V / 17 A UL: 300 V / 10 A	Box

## OMNIMATE Signal - series BL/SL 3.50 BL 3.50/18/270 SN BK BX

**Weidmüller Interface GmbH & Co. KG**  
 Klingenbergstraße 16  
 D-32758 Detmold  
 Germany  
 Fon: +49 5231 14-0  
 Fax: +49 5231 14-292083  
 www.weidmueller.com

### Mating connector (conditionally pluggable)

length (l): 3.2 mm, tinned,  
 Orange, Box

#### SL 3.50/180F

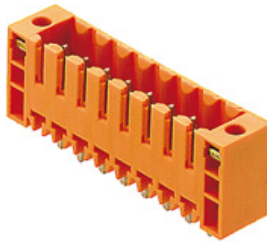

Male header with 3.50 mm pitch for wave soldering

- Plugging direction angled to the PCB (135°)
- Housing variant: screw flange (F)
- Packaged in cardboard box (BX)
- Male header can be coded

250 V (IEC) / 300 V (UL)  
 17 A (IEC) / 10 A (UL)

#### General ordering data

Type	Order No.	Version	GTIN (EAN)	Qty.	Product data	Packaging
SL 3.50/18/180F 3.2SN OR BX	<a href="#">1622190000</a>	PCB plug-in connector, male header, Flange, Solder connection, 3.50 mm, No. of poles: 18, 180°, Solder pin length (l): 3.2 mm, tinned, Orange, Box	4008190188894	20 pc(s).	IEC: 320 V / 17 A UL: 300 V / 10 A	Box

#### SL-SMT 3.5/180LF Box



**High-temperature-resistant male header, 3.50 mm pitch.**

- **Plugging direction parallel (90°), straight 180° or angled (135°) to PCB**
- **Housing variants: closed side (G), screw flange (F), solder flange (LF) or snap-on solder flange (RF)**
- **Optimised for the SMT process**
- **Pin length 3.2 mm universal for all soldering methods**
- **Pin length 1.5 mm optimised for reflow soldering methods**
- **Packed either in a box (BX) or tape-on-reel (RL)**
- **Male header can be coded**

#### General ordering data

Type	Order No.	Version	GTIN (EAN)	Qty.	Product data	Packaging
SL-SMT 3.50/18/180LF 3.2SN BK BX	<a href="#">1842700000</a>	PCB plug-in connector, male header, Solder flange, Reflow solder connection, 3.50 mm, No. of poles: 18, 180°, Solder pin length (l): 3.2 mm, tinned, Black, Box	4032248354061	20 pc(s).	IEC: 320 V / 15 A UL: 300 V / 10 A	Box

## OMNIMATE Signal - series BL/SL 3.50 BL 3.50/18/270 SN BK BX

**Weidmüller Interface GmbH & Co. KG**  
 Klingenbergstraße 16  
 D-32758 Detmold  
 Germany  
 Fon: +49 5231 14-0  
 Fax: +49 5231 14-292083  
 www.weidmueller.com

### Mating connector (conditionally pluggable)

SL-SMT 3.50/18/180LF 1.5SN BK BX	<a href="#">1804860000</a>	PCB plug-in connector, male header, Solder flange, Reflow solder connection, 3.50 mm, No. of poles: 18, 180°, Solder pin length (l): 1.5 mm, tinned, Black, Box	4032248268634 20 pc(s).	IEC: 320 V / 15 A UL: 300 V / 10 A	Box
--	----------------------------	--	-------------------------	---------------------------------------	-----

### SL 3.50/135F

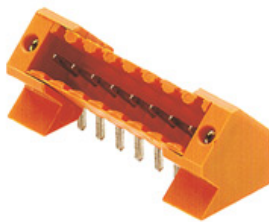

Male header with 3.50 mm pitch for wave soldering

- Plugging direction angled to the PCB (135°)
- Housing variant: screw flange (F)
- Packaged in cardboard box (BX)
- Male header can be coded

250 V (IEC) / 300 V (UL)  
 17 A (IEC) / 10 A (UL)

#### General ordering data

Type	Order No.	Version	GTIN (EAN)	Qty.	Product data	Packaging
SL 3.50/18/135F 3.2SN OR BX	<a href="#">1643490000</a>	PCB plug-in connector, male header, Flange, Solder connection, 3.50 mm, No. of poles: 18, 135°, Solder pin length (l): 3.2 mm, tinned, Orange, Box	4008190282257 20 pc(s).		IEC: 320 V / 15 A UL: 300 V / 10 A	Box

### SL-SMT 3.5/180F Box



**High-temperature-resistant male header, 3.50 mm pitch.**

- **Plugging direction parallel (90°), straight 180° or angled (135°) to PCB**
- **Housing variants: closed side (G), screw flange (F), solder flange (LF) or snap-on solder flange (RF)**
- **Optimised for the SMT process**
- **Pin length 3.2 mm universal for all soldering methods**
- **Pin length 1.5 mm optimised for reflow soldering methods**
- **Packed either in a box (BX) or tape-on-reel (RL)**
- **Male header can be coded**

#### General ordering data

Type	Order No.	Version	GTIN (EAN)	Qty.	Product data	Packaging
SL-SMT 3.50/18/180F 1.5SN BK BX	<a href="#">1761122001</a>	PCB plug-in connector, male header, Flange, Reflow solder connection, 3.50	4032248131693 20 pc(s).		IEC: 320 V / 15 A UL: 300 V / 10 A	Box

Creation date November 2, 2014 3:40:31 PM CET

## OMNIMATE Signal - series BL/SL 3.50 BL 3.50/18/270 SN BK BX

**Weidmüller Interface GmbH & Co. KG**  
 Klingenbergstraße 16  
 D-32758 Detmold  
 Germany  
 Fon: +49 5231 14-0  
 Fax: +49 5231 14-292083  
 www.weidmueller.com

### Mating connector (conditionally pluggable)

		mm, No. of poles: 18, 180°, Solder pin length (l): 1.5 mm, tinned, Black, Box		
SL-SMT 3.50/18/180F 3.2SN BK BX	<a href="#">1842930000</a>	PCB plug-in connector, male header, Flange, Reflow solder connection, 3.50 mm, No. of poles: 18, 180°, Solder pin length (l): 3.2 mm, tinned, Black, Box	4032248354399 20 pc(s). IEC: 320 V / 15 A UL: 300 V / 10 A	Box
2014-05-20T09:05:00	<a href="#">1761123001</a>	PCB plug-in connector, male header, Flange, Reflow solder connection, 3.50 mm, No. of poles: 18, 180°, Solder pin length (l): 1.5 mm, tinned, Black, Tray	4032248133505 18 pc(s). IEC: 320 V / 15 A UL: 300 V / 10 A	

### SLD 3.50V/90F



Two-tier offset male connector for wave soldering, with 3.50 mm pitch. The male connector is available in closed and flange versions. The male connectors provide space for labelling and can be coded.

- 250 V (IEC) / 300 V (UL)
- 10.5 A (IEC) / 8 A (UL)

### General ordering data

Type	Order No.	Version	GTIN (EAN)	Qty.	Product data	Packaging
SLD 3.50 V/36/90F 3.2 SN OR BX	<a href="#">1642450000</a>	PCB plug-in connector, male header, Flange, Solder connection, 3.50 mm, No. of poles: 36, 90°, Solder pin length (l): 3.2 mm, tinned, Orange, Box	4008190280970	10 pc(s).	IEC: 200 V / 10.5 A UL: 300 V / 8 A	Box

**OMNIMATE Signal - series BL/SL 3.50  
BL 3.50/18/270 SN BK BX**

**Weidmüller Interface GmbH & Co. KG**  
Klingenbergstraße 16  
D-32758 Detmold  
Germany  
Fon: +49 5231 14-0  
Fax: +49 5231 14-292083  
www.weidmueller.com

**Mating connector (conditionally pluggable)**
**SL-SMT 3.5/90F Box**

**High-temperature-resistant male header, 3.50 mm pitch.**

- **Plugging direction parallel (90°), straight 180° or angled (135°) to PCB**
- **Housing variants: closed side (G), screw flange (F), solder flange (LF) or snap-on solder flange (RF)**
- **Optimised for the SMT process**
- **Pin length 3.2 mm universal for all soldering methods**
- **Pin length 1.5 mm optimised for reflow soldering methods**
- **Packed either in a box (BX) or tape-on-reel (RL)**
- **Male header can be coded**

**General ordering data**

Type	Order No.	Version	GTIN (EAN)	Qty.	Product data	Packaging
SL-SMT	<a href="#">1842240000</a>	PCB plug-in connector, male	4032248353590	20 pc(s).	IEC: 320 V / 15 A UL: 300 V / 10 A	Box
3.50/18/90F		header, Flange, Reflow				
3.2SN BK BX		solder connection, 3.50 mm, No. of poles: 18, 90°, Solder pin length (l): 3.2 mm, tinned, Black, Box				

**SL-SMT 3.5/90LF Box**

**High-temperature-resistant male header, 3.50 mm pitch.**

- **Plugging direction parallel (90°), straight 180° or angled (135°) to PCB**
- **Housing variants: closed side (G), screw flange (F), solder flange (LF) or snap-on solder flange (RF)**
- **Optimised for the SMT process**
- **Pin length 3.2 mm universal for all soldering methods**
- **Pin length 1.5 mm optimised for reflow soldering methods**
- **Packed either in a box (BX) or tape-on-reel (RL)**
- **Male header can be coded**

**General ordering data**

Type	Order No.	Version	GTIN (EAN)	Qty.	Product data	Packaging
SL-SMT	<a href="#">1842010000</a>	PCB plug-in connector, male header, Solder flange, Reflow solder connection, 3.50 mm, No. of poles: 18,	4032248353361	20 pc(s).	IEC: 320 V / 15 A UL: 300 V / 10 A	Box
3.50/18/90LF						
3.2SN BK BX						

**OMNIMATE Signal - series BL/SL 3.50  
BL 3.50/18/270 SN BK BX**

**Weidmüller Interface GmbH & Co. KG**  
 Klingenbergstraße 16  
 D-32758 Detmold  
 Germany  
 Fon: +49 5231 14-0  
 Fax: +49 5231 14-292083  
 www.weidmueller.com

**Mating connector (conditionally pluggable)**

90°, Solder pin length (l):  
 3.2 mm, tinned, Black, Box

2014-05-20	2014-05-20	180510000	PCB plug-in connector, male header, Solder flange, Reflow solder connection, 3.50 mm, No. of poles: 18, 90°, Solder pin length (l): 1.5 mm, tinned, Black, Box	403224826900620 pc(s).	IEC: 320 V / 15 A UL: 300 V / 10 A
------------	------------	-----------	--	------------------------	------------------------------------

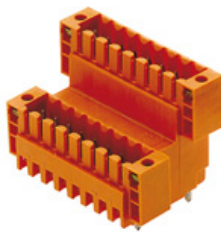
**SLD 3.50V/180F**

Two-tier offset male connector for wave soldering, with 3.50 mm pitch The male connector is available in closed and flange versions. The male connectors provide space for labelling and can be coded.

- 250 V (IEC) / 300 V (UL)
- 10.5 A (IEC) / 8 A (UL)

**General ordering data**

Type	Order No.	Version	GTIN (EAN)	Qty.	Product data	Packaging
SLD 3.50 V/36/180F 3.2 SN OR BX	<a href="#">1641320000</a>	PCB plug-in connector, male header, Flange, Solder connection, 3.50 mm, No. of poles: 36, 180°, Solder pin length (l): 3.2 mm, tinned, Orange, Box	4008190279721	10 pc(s).	IEC: 200 V / 10.5 A UL: 300 V / 8 A	Box

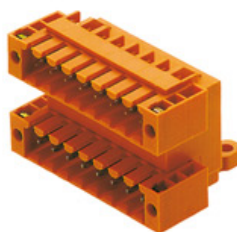
**SLD 3.50/90F**

Two-tier male connector for wave soldering, with 3.50 mm pitch The male connector is available in open, closed and flange versions. The male connectors provide space for labelling and can be coded. Packed in cardboard box.

- 250 V (IEC) / 300 V (UL)
- 10.5 A (IEC) / 8 A (UL)

**General ordering data**

Type	Order No.	Version	GTIN (EAN)	Qty.	Product data	Packaging
SLD 3.50/36/90F 3.2SN OR BX	<a href="#">1633970000</a>	PCB plug-in connector, male header, Flange, Solder connection, 3.50 mm, No. of poles: 36, 90°, Solder pin	4008190258429	10 pc(s).	IEC: 200 V / 10.5 A UL: 300 V / 8 A	Box

**OMNIMATE Signal - series BL/SL 3.50  
BL 3.50/18/270 SN BK BX**

**Weidmüller Interface GmbH & Co. KG**  
Klingenbergstraße 16  
D-32758 Detmold  
Germany  
Fon: +49 5231 14-0  
Fax: +49 5231 14-292083  
[www.weidmueller.com](http://www.weidmueller.com)

**Mating connector (conditionally pluggable)**

length (l): 3.2 mm, tinned,  
Orange, Box

## OMNIMATE Signal - series BL/SL 3.50 BL 3.50/18/270 SN BK BX

**Weidmüller Interface GmbH & Co. KG**  
 Klingenbergstraße 16  
 D-32758 Detmold  
 Germany  
 Fon: +49 5231 14-0  
 Fax: +49 5231 14-292083  
 www.weidmuller.com

### Mating connector (fully pluggable)

#### SL 3.50/180

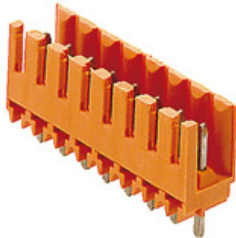

Male header with 3.50 mm pitch for wave soldering

- Plugging direction angled to the PCB (135°)
- Housing variant: screw flange (F)
- Packaged in cardboard box (BX)
- Male header can be coded

250 V (IEC) / 300 V (UL)  
 17 A (IEC) / 10 A (UL)

#### General ordering data

Type	Order No.	Version	GTIN (EAN)	Qty.	Product data	Packaging
SL	<a href="#">1621410000</a>	PCB plug-in connector, male header, open side, Solder connection, 3.50 mm, No. of poles: 18, 180°, Solder pin length (l): 3.2 mm, tinned, Orange, Box	4008190172169	20 pc(s).	IEC: 320 V / 17 A UL: 300 V / 10 A	Box

#### SL-SMT 3.5/90G Box



**High-temperature-resistant male header, 3.50 mm pitch.**

- **Plugging direction parallel (90°), straight 180° or angled (135°) to PCB**
- **Housing variants: closed side (G), screw flange (F), solder flange (LF) or snap-on solder flange (RF)**
- **Optimised for the SMT process**
- **Pin length 3.2 mm universal for all soldering methods**
- **Pin length 1.5 mm optimised for reflow soldering methods**
- **Packed either in a box (BX) or tape-on-reel (RL)**
- **Male header can be coded**

#### General ordering data

Type	Order No.	Version	GTIN (EAN)	Qty.	Product data	Packaging
SL-SMT	<a href="#">1841790000</a>	PCB plug-in connector, male header, closed side, Reflow solder connection, 3.50 mm, No. of poles: 18, 90°, Solder pin length (l): 3.2 mm, tinned, Black, Box	4032248353149	20 pc(s).	IEC: 320 V / 15 A UL: 300 V / 10 A	Box
2014-05-20T08:52:00	SL-SMT 3.5/90G 1.5SN BK BX		<a href="#">1761702001</a>	PCB plug-in connector, male header, closed side, Reflow		IEC: 320 V /

## OMNIMATE Signal - series BL/SL 3.50 BL 3.50/18/270 SN BK BX

**Weidmüller Interface GmbH & Co. KG**  
 Klingenbergstraße 16  
 D-32758 Detmold  
 Germany  
 Fon: +49 5231 14-0  
 Fax: +49 5231 14-292083  
 www.weidmueller.com

### Mating connector (fully pluggable)

solder connection,	15
3.50 mm, No.	A
of poles: 18,	UL:
90°, Solder pin	300
length (l): 1.5 mm,	V /
tinned, Black, Box	10
	A

### SLD 3.50V/90G



Two-tier offset male connector for wave soldering, with 3.50 mm pitch The male connector is available in closed and flange versions. The male connectors provide space for labelling and can be coded.

- 250 V (IEC) / 300 V (UL)
- 10.5 A (IEC) / 8 A (UL)

#### General ordering data

Type	Order No.	Version	GTIN (EAN)	Qty.	Product data	Packaging
SLD	<a href="#">1642320000</a>	PCB plug-in connector, male	4008190280840	10 pc(s).	IEC: 200 V / 10.5 A	Box
3.50V/36/90G		header, closed side, Solder connection, 3.50 mm, No. of poles: 36, 90°, Solder pin			UL: 300 V / 8 A	
3.2SN OR BX		length (l): 3.2 mm, tinned, Orange, Box				

### SLD 3.50/90

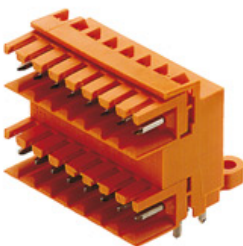

Two-tier male connector for wave soldering, with 3.50 mm pitch The male connector is available in open, closed and flange versions. The male connectors provide space for labelling and can be coded. Packed in cardboard box.

- 250 V (IEC) / 300 V (UL)
- 10.5 A (IEC) / 8 A (UL)

#### General ordering data

Type	Order No.	Version	GTIN (EAN)	Qty.	Product data	Packaging
SLD	<a href="#">1633510000</a>	PCB plug-in connector, male	4008190257965	10 pc(s).	IEC: 200 V / 10.5 A	Box
3.50/36/90		header, open side, Solder connection, 3.50 mm, No. of poles: 36, 90°, Solder pin			UL: 300 V / 8 A	
3.2SN OR BX		length (l): 3.2 mm, tinned, Orange, Box				

**OMNIMATE Signal - series BL/SL 3.50  
BL 3.50/18/270 SN BK BX**

**Weidmüller Interface GmbH & Co. KG**  
Klingenbergstraße 16  
D-32758 Detmold  
Germany  
Fon: +49 5231 14-0  
Fax: +49 5231 14-292083  
www.weidmueller.com

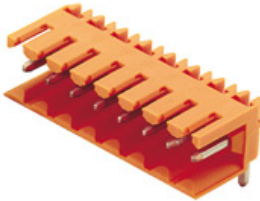
**Mating connector (fully pluggable)**
**SL 3.50/90**

Male header with 3.50 mm pitch for wave soldering

- Plugging direction angled to the PCB (135°)
- Housing variant: screw flange (F)
- Packaged in cardboard box (BX)
- Male header can be coded

250 V (IEC) / 300 V (UL)  
17 A (IEC) / 10 A (UL)

**General ordering data**

Type	Order No.	Version	GTIN (EAN)	Qty.	Product data	Packaging
SL	<a href="#">1619000000</a>	PCB plug-in connector, male	4008190132156	20 pc(s).	IEC: 320 V / 17 A	Box
3.50/18/90		header, open side, Solder connection, 3.50 mm, No. of poles: 18, 90°, Solder pin length (l): 3.2 mm, tinned, Orange, Box			UL: 300 V / 10 A	

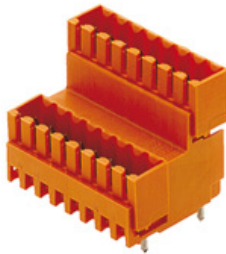
**SLD 3.50V/180G**

Two-tier offset male connector for wave soldering, with 3.50 mm pitch The male connector is available in closed and flange versions. The male connectors provide space for labelling and can be coded.

- 250 V (IEC) / 300 V (UL)
- 10.5 A (IEC) / 8 A (UL)

**General ordering data**

Type	Order No.	Version	GTIN (EAN)	Qty.	Product data	Packaging
SLD	<a href="#">1641190000</a>	PCB plug-in connector, male header, closed side, Solder connection, 3.50 mm, No. of poles: 36, 180°, Solder pin length (l): 3.2 mm, tinned, Orange, Box	4008190279592	10 pc(s).	IEC: 200 V / 10.5 A	Box
3.50V/36/180G					UL: 300 V / 8 A	

**OMNIMATE Signal - series BL/SL 3.50  
BL 3.50/18/270 SN BK BX**

**Weidmüller Interface GmbH & Co. KG**  
Klingenbergstraße 16  
D-32758 Detmold  
Germany  
Fon: +49 5231 14-0  
Fax: +49 5231 14-292083  
www.weidmueller.com

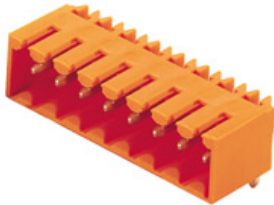
**Mating connector (fully pluggable)**
**SL 3.50/90G**

Male header with 3.50 mm pitch for wave soldering

- Plugging direction angled to the PCB (135°)
- Housing variant: screw flange (F)
- Packaged in cardboard box (BX)
- Male header can be coded

250 V (IEC) / 300 V (UL)  
17 A (IEC) / 10 A (UL)

**General ordering data**

Type	Order No.	Version	GTIN (EAN)	Qty.	Product data	Packaging
SL	<a href="#">1619390000</a>	PCB plug-in connector, male	4008190138950	20 pc(s).	IEC: 320 V / 17 A	Box
3.50/18/90G		header, closed side, Solder connection, 3.50 mm, No. of poles: 18, 90°, Solder pin length (l): 3.2 mm, tinned, Orange, Box			UL: 300 V / 10 A	

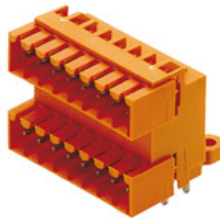
**SLD 3.50/90G**

Two-tier male connector for wave soldering, with 3.50 mm pitch The male connector is available in open, closed and flange versions. The male connectors provide space for labelling and can be coded. Packed in cardboard box.

- 250 V (IEC) / 300 V (UL)
- 10.5 A (IEC) / 8 A (UL)

**General ordering data**

Type	Order No.	Version	GTIN (EAN)	Qty.	Product data	Packaging
SLD	<a href="#">1633740000</a>	PCB plug-in connector, male	4008190258191	10 pc(s).	IEC: 200 V / 10.5 A	Box
3.50/36/90G		header, closed side, Solder connection, 3.50 mm, No. of poles: 36, 90°, Solder pin length (l): 3.2 mm, tinned, Orange, Box			UL: 300 V / 8 A	

**OMNIMATE Signal - series BL/SL 3.50  
BL 3.50/18/270 SN BK BX**

**Weidmüller Interface GmbH & Co. KG**  
Klingenbergstraße 16  
D-32758 Detmold  
Germany  
Fon: +49 5231 14-0  
Fax: +49 5231 14-292083  
www.weidmueller.com

**Mating connector (fully pluggable)**
**SL-THR 3.5/135F**

**High-temperature-resistant male header, 3.50 mm pitch.**

- **Plugging direction parallel (90°), straight 180° or angled (135°) to PCB**
- **Housing variants: closed side (G), screw flange (F), solder flange (LF) or snap-on solder flange (RF)**
- **Optimised for the SMT process**
- **Pin length 3.2 mm universal for all soldering methods**
- **Pin length 1.5 mm optimised for reflow soldering methods**
- **Packed either in a box (BX) or tape-on-reel (RL)**
- **Male header can be coded**

**General ordering data**

Type	Order No.	Version	GTIN (EAN)	Qty.	Product data	Packaging
SL-SMT	<a href="#">1003680000</a>	PCB plug-in connector, male	4032248700301	20 pc(s).	IEC: 320 V / 15 A UL: 300 V / 10 A	Box
3.50/18/135F		header, Flange, Reflow				
3.2SN BK BX		solder connection, 3.50 mm, No. of poles: 18, 135°, Solder pin length (l): 3.2 mm, tinned, Black, Box				

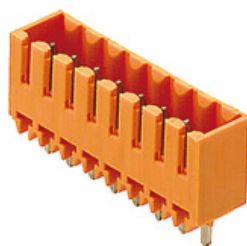
**SL 3.50/180G**

Male header with 3.50 mm pitch for wave soldering

- **Plugging direction angled to the PCB (135°)**
- **Housing variant: screw flange (F)**
- **Packaged in cardboard box (BX)**
- **Male header can be coded**

250 V (IEC) / 300 V (UL)  
17 A (IEC) / 10 A (UL)

**General ordering data**

Type	Order No.	Version	GTIN (EAN)	Qty.	Product data	Packaging
SL	<a href="#">1621800000</a>	PCB plug-in connector, male header, closed side,	4008190180676	20 pc(s).	IEC: 320 V / 17 A UL: 300 V / 10 A	Box
3.50/18/180G		Solder connection, 3.50 mm, No. of poles: 18, 180°, Solder pin length (l): 3.2 mm, tinned, Orange, Box				
3.2SN OR BX						

# Addresses worldwide

Let's connect.

- AE United Arab Emirates**  
Weidmüller Middle East FZE  
Warehouse Q3-79  
SAIF-Zone  
P.O. BOX 8591  
Sharjah  
Tel. +971 65572723  
Fax +971 65572724  
wme.info@weidmuller.com
- AO Angola**  
Please contact  
Phambili Interface  
South Africa
- AR Argentina**  
CPI SA  
Bauness 2660  
C1431DOF Buenos Aires  
Tel. +54 11 4523 8008  
Fax +54 11 4522 0546  
info@cpi.com.ar  
www.cpi.com.ar
- AT Austria**  
Weidmüller GmbH  
IZ NOE Süd Straße 2b, Obj  
M 59  
2355 Wiener Neudorf  
Tel. +43 2236 67080  
Fax +43 2236 6708-899  
office.at@weidmuller.com  
www.weidmuller.com
- AU Australia**  
Weidmüller Pty. Ltd.  
PO BOX 6944  
Huntingwood 2148  
Huntingwood Drive 43  
Huntingwood NSW 2148  
Tel. +61 2 9671 9999  
Fax +61 2 9671 9911  
info@weidmuller.com.au  
www.weidmuller.com.au
- AZ Azerbaijan**  
Representative Office  
Rashad Mahmudov  
Demirchi Tower, 4th floor  
37, Khojali ave.  
AZ 1025 Baku  
Tel. +994 12 488 80 36  
Fax +994 12 488 80 37  
rashad.mahmudov@weidmuller.com
- BA Bosnia and Herzegovina**  
Please contact  
our Representative Office  
Weidmüller Interface GmbH  
& Co. KG  
Serbia  
or  
BIG electric d.o.o  
Mladena Stojanovića 117A  
78000 Banja Luka  
Tel. +387 51926277  
Fax +387 51926277  
bigelectric@blic.net  
www.bigelectric.ba
- BE Belgium**  
Weidmüller Benelux B. V.  
Mechelsesteenweg 519 bus  
6 en 7  
1930 Nossegem  
Tel. +32 2 752 40 70  
Fax +32 2 751 36 06  
info@weidmuller.be  
www.weidmuller.be
- BG Bulgaria**  
Weid-Bul EOOD  
Bul. „Kliment Ohridski“ 13  
1756 Sofia  
Tel. +359 2 963 2560  
Fax +359 2 963 1098  
sofia@weidbul.com  
www.weidbul.com
- BH Bahrain**  
Khayber Trading Company  
P.O. Box 1976  
Manama  
Tel. +973 720747  
Fax +973 720331  
khayber@batelco.com.bh
- BR Brazil**  
Weidmüller Conexel do Brasil  
Conexes Elétricas Ltda.  
Av. Presidente Juscelino, 642  
- Piraporinha  
Diadema, São Paulo  
09950-370  
Tel. +55 (11) 4366-9600  
Fax +55 (11) 4362-1677  
vendas@weidmuller.com.br  
www.weidmuller.com.br
- BW Botswana**  
Please contact  
Phambili Interface  
South Africa
- BY Belarus**  
TECHNIKON Ltd.  
Nezavisimosti pr. 177-9  
220125 Minsk  
Tel. +375 17 393-11-77  
Fax +375 17 3930080  
wm@technikon.by
- CA Canada**  
W Interconnections Canada  
Inc.  
10 Spy Court  
Markham Ontario L3R 5H6  
Tel. +1 (905) 475-1507  
Ext. 9836  
Fax +1 (905) 475-2798  
support@weidmuller.ca  
www.weidmuller.ca
- CG Congo**  
Please contact  
Phambili Interface  
South Africa
- CH Switzerland**  
Weidmüller Schweiz AG  
Rundbuckstraße 2  
8212 Neuhausen am  
Rheinfall SH  
Tel. +41 52 674 07 07  
Fax +41 52 674 07 08  
info@weidmuller.ch  
www.weidmuller.ch
- CL Chile**  
ATS-INTECH  
Maria Luisa Santander 0475  
Santiago  
Providencia 7500859  
Tel. +56 2 341 1271  
Fax +56 2 341 1275  
felipe@atsintech.com  
www.atsintech.com  
CPI CHILE LTDA  
Av. Presidente Frei Montalva  
6001, 47 complejo el cortijo  
Santiago - Conchalí  
Tel. +562 963 8440  
Fax +562 963 8440  
cpi@cpichile.cl  
www.cpicichile.cl
- CN China**  
Weidmüller Interface  
(Shanghai) Co. Ltd.  
100 Yutong Road  
25 F, BM Intercontinental  
Business Center  
200070 Shanghai  
Tel. +86 21-22195008  
Fax +86 21-22195009  
customer.hotline@weidmuller.com.cn  
www.cnweidmuller.com
- CO Colombia**  
Automatización Avanzada  
S. A.  
Carrera 97 No., 24 c - 23  
Bodega 4  
110911 Bogotá-D.C.  
Tel. +57 (1) 547-8510  
Fax +57 (1) 422-3044  
comercial@automatizacionavanzada.com  
www.automatizacionavanzada.com
- CR Costa Rica**  
ELVATRON S. A.  
la Uruca 400 Norte Banco  
Costa Rica  
San Jose Costa Rica  
Tel. +506 2961-060  
Fax +506 5200-609  
dirk.haase@elvatron.com  
www.elvatron.com
- CZ Czech Republic**  
Weidmüller s.r.o.  
Lomnického 5/1705  
140 00 Praha 4  
Tel. +420 244 001 400  
Fax +420 244 001 499  
office@weidmuller.cz  
www.weidmuller.cz
- DE Germany**  
Weidmüller GmbH & Co. KG  
Olmstraße 9  
32758 Detmold  
Postfach 30 54  
32720 Detmold  
Tel. +49 5231 1428-0  
Fax +49 5231 1428-116  
weidmuller@weidmuller.de  
www.weidmuller.de
- DK Denmark**  
Weidmüller Danmark  
Vallensbækvej 18A  
2605 Brøndby  
Tel. +45 27747800  
kundeservice@weidmuller.dk  
www.weidmuller.dk
- EC Ecuador**  
Elsystec S. A., Electricidad  
Sistemas y Tecnología  
Vasco de Contreras N35-25 1  
y Mañosa  
Quito - Pichincha  
Tel. +593 22456510  
Fax +593 22456755  
Elsystec@uio.satnet.net
- EE Estonia**  
Please contact  
our Representative Office  
Weidmüller Interface GmbH  
& Co. KG  
Latvia  
or  
Soots Interface OÜ  
Pärnu mnt 142  
11317 Tallinn  
Tel. +372 609 6933  
Fax +372 609 6933  
info@sootsinterface.ee  
www.sootsinterface.ee
- EG Egypt**  
Standard Electric (OMEGA)  
87, Mohamed Farid Street  
Heliopolis  
Cairo  
Tel. +202 26229000  
Fax +202 26221555  
stdelec@rite.com
- ES Spain**  
Weidmüller, S. A.  
Narcis Monturiol 11-13, Pol.  
Ind. Sudoeste  
8960 Sant Just  
Desvern - Barcelona  
Tel. +34 934 803 386  
Fax +34 933 718 055  
weidmuller@weidmuller.es  
www.weidmuller.es
- FI Finland**  
Weidmüller Suomi,  
Weidmüller Aktiebolagetin  
sivillike  
Koy Plaza Vivace  
Ayritie 8C  
FI 1510 Vantaa  
Tel. +358 20 7351300  
Fax +358 800 114 667  
asiakaspalvelu@weidmuller.fi  
www.weidmuller.fi
- FR France**  
Weidmüller E. U. R. L.  
12, Chaussée Jules César  
BP 263 Osny  
95523 Cergy-Pontoise Cedex  
Tel. +33 1 34 24 55 00  
Fax +33 1 34 24 55 01  
mail@weidmuller.fr
- GB Great Britain**  
Weidmüller Ltd.  
Klippon House  
Centurion Court Office Park,  
Meridian East, Meridian  
Business Park  
Leicester  
LE19 1TP  
Tel. +44 116 282 3470  
Fax +44 116 289 3582  
marketing@weidmuller.co.uk  
www.weidmuller.co.uk
- GE Georgia**  
Please contact  
our Representative Office  
Rashad Mahmudov  
Azerbaijan.
- GR Greece**  
G.A. Solutions  
Ippokratous 11 Metamorfosi  
144 52 Athen  
Tel. +30 210 2823233  
Fax +30 210 2823233  
info@weidmuller.gr  
www.weidmuller.gr
- GT Guatemala**  
Prestelectro, Prestegard  
Electro. S.A.  
Avenida Petapa 44-22,  
Zona 12  
Guatemala City  
Tel. +502 2442-3346  
Fax +502 2476-8945  
ventas@prestelectro.com
- HK Hong Kong**  
Weidmüller (Hong Kong)  
Limited Co. Ltd.  
Unit 1617, Metropolis Tower  
No. 10 Metropolis Drive,  
Hungghom, Kowloon  
Tel. +852 3154 8088  
Fax +852 31548099  
Info-hk@weidmuller.com.hk
- HR Croatia**  
ElektroPARTNER d.o.o.  
Slavonska avenija 24/6  
HR-10000 Zagreb  
Tel. +385 (1) 6184 793  
Fax +385 (1) 6184 795  
elektropartner@zg-t.com.hr  
www.elektropartner.hr
- HU Hungary**  
Weidmüller Kereskedelmi Kft.  
Budapest  
Gubacsi út 6.  
1097  
Tel. +36 1 382 7700  
Fax +36 1 382 7701  
info@weidmuller.hu  
www.weidmuller.hu
- ID Indonesia**  
PT. Nego Electrindo  
Ruko Mega Grosir Cempaka  
Mas Blok I No. 20 - 22  
Jakarta 10640  
Tel. +62 21 42882255  
Fax +62 21 42882266  
sales@negoelectrindo.co.id
- IE Ireland**  
Please contact  
Weidmüller Ltd.  
Great Britain
- IL Israel**  
A. U. Shay Ltd.  
23/25, Embar Street  
49222 Petach-Tikva  
P.O. Box 1 00 49  
49222 Petach-Tikva  
Tel. +972 3-923-3601  
Fax +972 3-923-4601  
shay@uriel-shay.com  
www.uriel-shay.com  
ATEKA Ltd.  
4, Ha Tavor lane Industrial  
area Segula  
49691 Petach-Tikva  
P.O. Box 4710  
Petach-Tikva  
Tel. +972 73-200-1311  
Fax +972 3-924 4245  
marketing@ateka.co.il  
www.ateka.co.il
- IN India**  
Representative Office  
Weidmüller Electronics India  
Pvt. Ltd.  
12th Lane North Avenue, Opp  
Joggers Park,  
Kalyani Nagar, Pune  
411 006  
Tel. +91 20-41290090  
Nitish.Rajan@weidmuller.de  
www.weidmuller.com
- IS Iceland**  
Samey Automation Center  
Lyngas 13  
210 Garoabaer  
Tel. +354 5 10 5200  
Fax +354 5 10 5201  
Samey@samey.is  
www.samey.is
- IT Italy**  
Weidmüller S. r.l.  
Via Albert Einstein 4  
20092 Cinisello  
Balsamo Milano  
Tel. +39 02 660681  
Fax +39 02 6124945  
weidmuller@weidmuller.it  
www.weidmuller.it
- JM Jamaica**  
Please contact  
W Interconnections Inc.  
United States
- JO Jordan**  
Trans Jordan for Electro  
PO Box 33 06 07  
Amman  
Tel. +962 6 533 2020  
Fax +962 6 533 5800  
transjordan@batelco.jo
- JP Japan**  
Nihon Weidmüller Co. Ltd.  
Sphere Tower Tennoz 2-2-8  
Higashi-Shinagawa,  
Shinagawa-ku  
Tokyo  
140-0002  
Tel. +81 3 6711 5300  
Fax +81 3 6711 5333  
weidmullerjapan@weidmuller.co.jp  
www.weidmuller.co.jp
- KE Kenya**  
Please contact  
Phambili Interface  
South Africa
- KR Korea**  
Weidmüller Korea Co. Ltd.  
9th floor, Wonbang B/D  
Samsseong 2-Dong, Gangnam-Gu  
Seoul 143-42  
Tel. +82 2-516-0003  
Fax +82 2-516-0090  
info@weidmuller.co.kr  
www.weidmuller.co.kr
- KZ Kazakhstan**  
Please contact  
OOO Weidmüller  
Russia
- LT Lithuania**  
Please contact  
our Representative Office  
Weidmüller Interface GmbH  
& Co. KG  
Latvia  
or  
ELEKTROS IRANGA  
Tinklu g. 29 a  
LT-5319 Panevezys  
Tel. +370 (45) 582 828  
Fax +370 (45) 582 727  
info@eliranga.lt
- LU Luxembourg**  
Please contact  
Weidmüller Benelux B. V.  
Netherlands



You can find all Weidmüller addresses and your local contact on the internet at: [www.weidmuller.com/countries](http://www.weidmuller.com/countries)

Sales company 

Representation abroad 

without representation abroad 

Let's connect.

- LV Latvia**  
SIA Abi4  
Daugavgrivas 31b  
Riga, LV-1007  
Tel. +371 674 70999  
Fax +371 674 65637  
abi\_4@tvnet.lv  
  
Representative Office  
Weidmüller Interface GmbH & Co. KG  
Udens str. 12-118  
Riga, LV-1007  
Tel. +371 29254766  
Fax +371 676 24562  
lgonis.rudaks@weidmuller.com  
www.weidmuller.com
- MD Moldova**  
BERHORD A & D srl  
79/1, str. Milescu Spartaru  
MD-2075 Chisinau  
Moldova  
Tel. +373 (22) 815002  
Fax +373 (22) 815007  
atiuleanu@berhord.com  
www.ad.berhord.com
- ME Montenegro**  
Please contact our Representative Office  
Weidmüller Interface GmbH & Co. KG  
Serbia.
- MG Madagascar**  
Please contact Phambili Interface  
South Africa
- MK Macedonia**  
Please contact our Representative Office  
Weidmüller Interface GmbH & Co. KG  
Serbia  
  
or  
ELEKTRO - SMK dool  
UL. III Makedonska brigada  
b.b.  
1000 Skopje  
Tel. +389 22460295  
Fax +389 22460298  
Elektro-smk@telekabel.net.mk
- MT Malta**  
E. S. S., Electrical Supplies & Services Ltd.  
San Gwakklin Road  
Mrieהל  
  
Tel. +356 21255777  
Fax +356 21255999  
robert.agiuss@ess.com.mt
- MU Mauritius**  
Mubelo Electrical Ltd.  
Office 26, Gateway building,  
St Jean Road  
Quatre Bornes  
Mauritius  
Tel. +230 4670989  
Fax +230 4654051  
richard.mubelo@orange.mu
- MW Malawi**  
Please contact Phambili Interface  
South Africa
- MX Mexico**  
W Interconnections S. A.  
DE C. V.  
Bvd. Hermanos Serdán 698,  
Col. San Rafael Oriente  
72029 Puebla  
Tel. +52 (222) 268 6227  
Fax +52 (222) 286 6242  
clientes@weidmuller.com.mx
- MY Malaysia**  
Connect Plus Technology  
Sdn Bhd  
No. 43, Jalan PJS 11/22,  
Bandar Sunway  
46150 Petaling Jaya  
Selangor Darul Ehsan  
Tel. +60 3 5633 7363  
Fax +60 3 5633 6562  
paul@cpotech.com.my  
www.cpotech.com.my
- MZ Mozambique**  
Please contact Phambili Interface  
South Africa
- NA Namibia**  
Please contact Phambili Interface  
South Africa
- NG Nigeria**  
Please contact Phambili Interface  
South Africa
- NL Netherlands**  
Weidmüller Benelux B. V.  
Franciscusweg 221  
1216 SE Hilversum  
P.O. Box 1505  
1200 BM Hilversum  
Tel. +31 35 626 12 61  
Fax +31 35 623 20 44  
info@weidmuller.nl  
www.weidmuller.nl
- NO Norway**  
Sivilingeniør J.F. Knudtzen AS  
Billingstadsetta 97  
1396 Billingstad  
PO Box 160  
1378 Nesbru  
Tel. +47 66 98 33 50  
Fax +47 66 98 09 55  
firmapost@jfknudtzen.no  
www.jfknudtzen.no
- NZ New Zealand**  
Cuthbert S. Stewart Ltd.  
27 Te Puni Street  
Petone  
PO Box 38496  
Wellington Mail Centre 5054  
Tel. (04) 568 6156  
Fax (04) 568 6056  
csi@cuthbertstewart.co.nz  
  
Cuthbert S. Stewart Ltd  
4 Fred Thomas Drive  
Aon Building, Ground Floor,  
South Entry  
Takapuna  
PO Box 100 338  
North Shore City 745  
Tel. (09) 489 1751  
Fax (09) 489 1752  
cslak@cuthbertstewart.co.nz
- OM Oman**  
DAN INTERNATIONAL LLC.  
Ghala St. 111  
BP 2901  
Seeb  
Tel. +968 5036 77  
Fax +968 5037 55  
yedu@danintl.com
- PE Peru**  
IMPEXINCA S.A.C.  
Calle Ortiz de Zevallos No.  
105, Urb. San Antonio  
18  
Lima, Miraflores  
Tel. +51 1 447 5608  
info@impexinca.pe  
www.impexinca.pe  
  
J & W CIA. S. A.  
Calle 6 Mz. D Lte. 23, Urb.  
Ind. Grimanesa  
1  
Callao  
Tel. +51 1 572 2539  
Fax +51 1 572 0152  
contacto@jwcia.com  
www.jwcia.com
- PH Philippines**  
Enclosure Systems Specialists  
Inc.  
2276 Don Chino Roces  
Avenue Extension  
Room 103/105 Narra Building  
1231 Makati City  
Tel. +63 2 813 8580  
Fax +63 2 813 8596  
sales\_encsys@pltdsl.net  
www.enclosuresystemsph.com
- PK Pakistan**  
Automation Controls (Pak)  
Apartment No. 33 C III,  
Chenab Block, Allama Iqbal  
Town  
Lahore  
Tel. +92 42 37809948  
Fax +92 42 37809950  
nadeem@acpak.com.pk  
www.acpak.com.pk
- PL Poland**  
Weidmüller Sp. z o. o.  
ul. Ogrodowa 58  
00-876 Warszawa  
Tel. +48 22 510 09 40  
Fax +48 22 510 09 41  
biuro@weidmuller.com.pl  
www.weidmuller.pl
- PR Puerto Rico**  
Please contact W Interconnections Inc.  
United States
- PT Portugal**  
Weidmüller Sistemas de Interface S. A.  
Estrada Outeiro Polima, R.  
Augusto Dias da Silva, Lote  
B - Esct. 2  
São Domingos de Rana  
2785-515 Abóboda  
Tel. +351 214 459 191  
Fax +351 214 455 871  
weidmuller@weidmuller.pt  
www.weidmuller.pt
- PY Paraguay**  
Please contact CPI SA  
Argentina
- RO Romania**  
Representative Office  
Weidmüller Interface GmbH & Co. KG  
Ionescu Crum Street, No.  
1, 1st Tower, 1st Floor,  
Office 4  
500446 Brasov - Brasov  
Business Park  
Tel. +40 (268) 446 222  
Fax +40 (268) 446 224  
claudiu.totea@weidmuller.com  
www.weidmuller.com
- RS Serbia**  
Representative Office  
Weidmüller Interface GmbH & Co. KG  
Ustanička 189, III sprat  
Iokal 7a  
11050 Beograd  
Tel. +381 11 2885274  
Fax +381 11 2885274  
zoran.rabrenovic@weidmuller.com
- RU Russia**  
OOO Weidmüller  
Warshavskoye highway, 25  
A, bld. 6  
Moskau  
117105  
Tel. +7 (495) 771-69-40  
Fax +7 (495) 771-69-41  
Info@weidmuller.ru  
www.weidmuller.ru
- SA Saudi Arabia**  
Please contact Weidmüller Middle East FZE  
United Arab Emirates
- SE Sweden**  
Weidmüller AB  
Axel Danielssons väg 271  
BOX 31025  
SE-200 49 Malmö  
Tel. +46 77-143 00 44  
Fax +46 40-37 48 60  
info@weidmuller.se  
www.weidmuller.se
- SG Singapore**  
Weidmüller Pte. Ltd.  
70 Bendemeer Road  
# 04-03 Luzerne Building  
Singapore 339940  
Tel. +65 6841 5311  
Fax +65 6841 5377  
info@weidmuller.com.sg  
www.weidmuller.com.sg
- SI Slovenia**  
Elektrospoji d. o. o.  
Stegne 27  
SI- 1000 Ljubljana  
Osrednjeslovenska  
Tel. +386 1 511 3810  
Fax +386 1 511 1604  
info@elektrospoji.si  
www.elektrospoji.si
- SK Slovakia**  
ELEKTRIS s.r.o.  
Elektrárnská 1  
831 04 Bratislava  
Tel. +421 2/4920 0113  
Fax +421 2/4920 0119  
bratislava@elektris.sk
- SV El Salvador**  
Prestegard Electro  
11 Avenida Norte No. 240  
Edificio Salazar No. 2  
San Salvador  
Tel. +503 2271 1690  
Fax +503 2221 3851  
prestegard@navegante.com.sv
- SY Syria**  
Please contact Weidmüller Middle East FZE  
United Arab Emirates
- SZ Swaziland**  
Please contact Phambili Interface  
South Africa
- TH Thailand**  
Pisanu Engineering Co. Ltd.  
Kwang Dingaeng, Khet  
Dingaeng  
800/2 Soi Trakulsuk, Asoke-  
dindaeng Road  
Dindaeng, Bangkok  
10400  
Tel. +66 2 248 2896  
Fax +66 2 642 9220  
ecsales@pisanu.co.th  
www.pisanu.co.th  
  
Representative Office  
Weidmüller Pte. Ltd.  
37/F, Sathorn Square Building  
98 North Sathorn Road  
Bangkok, Silom Bangrak  
10500  
Tel. +66 2 105 6300  
Fax +662 105 6301  
info@weidmuller.com.sg
- TN Tunisia**  
Please contact Weidmüller E. U. R. L.  
France
- TR Turkey**  
Weidmüller Elektronik Ticaret  
Ltd. Sirketi  
Kavacık Mah. Orhan Veli Kanık  
Caddesi 9/1  
34810 Beykoz / Istanbul  
Tel. +90 (216) 537 10 70  
Fax +90 (216) 537 10 77  
info@weidmuller.com.tr  
www.weidmuller.com.tr
- TW Taiwan**  
Weidmüller (Hong Kong)  
Limited  
No. 3, Lane 89, ChungYang  
N. Rd.  
24148 SanChuang City,  
Taipei  
Tel. +886 921 949 751  
roy.lin@weidmuller.com.hk
- TZ Tanzania**  
Please contact Phambili Interface  
South Africa
- UA Ukraine**  
LLC WM UKRAINE  
Levanevskogo str. 6  
Kiev  
3058  
Tel. +38 044 490 32 48  
Fax +38 044 490 32 49  
info@wm-ua.com.ua  
wm-ua.com.ua/  
  
Representative Office  
Weidmüller Interface GmbH & Co. KG  
Z. office 303  
7-D, Zdobunivska str.  
Kiev, 2081  
Mobile +38 050 440 25 24  
info.ua@weidmuller.com
- US United States**  
W Interconnections Inc.  
821 Southlake Boulevard  
Richmond Virginia 23236  
Tel. +1 (804) 794-2877  
Fax +1 (804) 379-2593  
info@weidmuller.com  
www.weidmuller.com
- UZ Republic of Uzbekistan**  
Please contact OOO Weidmüller  
Russia
- VN Vietnam**  
AUMI Industrial Equipment &  
Automation Company Limited  
E1, La Thanh Hotel  
218 Doi Can Street  
Lieu Giai Ward, Ba Dinh  
District  
Hanoi City  
Tel. +84 4 37628601  
Fax +84 4 62661391  
aumi@aumi.com.vn  
www.aumi.com.vn  
  
Representative Office  
Weidmüller Pte. Ltd.  
Level 16 Saigon Tower  
Building  
29 Le Duan Street  
District 1  
Ho Chi Minh  
Tel. +848 3520 7717  
Fax +848 3520 7604  
info@weidmuller.com.sg
- ZA South Africa**  
Phambili Interface  
PO Box 193  
1609 Johannesburg, Edenvale  
5 Bundo Road, Sebenza  
1610 Johannesburg  
Tel. +27 (11) 4521930  
Fax +27 (11) 4526455  
info@weidmuller.co.za  
www.weidmuller.co.za
- ZM Zambia**  
Please contact Phambili Interface  
South Africa
- ZW Zimbabwe**  
Please contact Phambili Interface  
South Africa

