

**OMNIMATE Signal - series BL/SL 3.50**  
**BL 3.50/24/90 SN BK BX**

**Weidmüller Interface GmbH & Co. KG**  
 Klingenbergstraße 16  
 D-32758 Detmold  
 Germany  
 Fon: +49 5231 14-0  
 Fax: +49 5231 14-292083  
 www.weidmueller.com

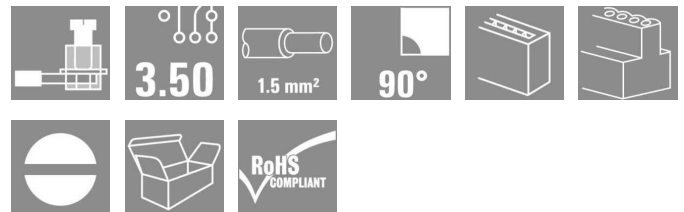

Female connectors with clamping yoke screw system for connecting conductors at 3.50 mm pitch. They provide space for labelling and can be coded.

**General ordering data**

Type	BL 3.50/24/90 SN BK BX
Order No.	<a href="#">1639000000</a>
Version	PCB plug-in connector, female plug, 3.50 mm, No. of poles: 24, 90°, Clamping yoke connection, Clamping range, rated connection, max.: 1.5 mm², Box
GTIN (EAN)	4008190276546
Qty.	20 pc(s).
Product data	IEC: 320 V / 12 A / 0.2 - 1.5 mm² UL: 300 V / 8 A / AWG 28 - AWG 14
Packaging	Box

**OMNIMATE Signal - series BL/SL 3.50  
BL 3.50/24/90 SN BK BX**

**Weidmüller Interface GmbH & Co. KG**  
 Klingenbergstraße 16  
 D-32758 Detmold  
 Germany  
 Fon: +49 5231 14-0  
 Fax: +49 5231 14-292083  
 www.weidmueller.com

**Technical data****Dimensions and weights**

Net weight	23.85 g
------------	---------

**System parameters**

Product family		Type of connection	
Product family	OMNIMATE Signal - series BL/SL 3.50	Type of connection	Field connection
Wire connection method	Clamping yoke connection	Pitch in mm (P)	3.5 mm
Pitch in inches (P)	0.138 inch	Conductor outlet direction	90°
No. of poles	24	L1 in mm	80.5 mm
L1 in inches	3.169 inch	Number of rows	1
Pin series quantity	1	Rated cross-section	1.5 mm <sup>2</sup>
Touch-safe protection acc. to DIN VDE 57 106	Safe from finger touch	Touch-safe protection acc. to DIN VDE 0470	IP 20
Can be coded	Yes	Stripping length	6 mm
Tightening torque, min.	0.2 Nm	Tightening torque, max.	0.25 Nm
Clamping screw	M 2	Screwdriver blade	0.4 x 2.5
Screwdriver blade standard	DIN 5264	Plugging cycles	25
push-in force/pole	10 N	Withdrawal force per pole	4 N
Packaging	Box		

**Material data**

Insulating material	PBT	Colour	Black
Colour chart (similar)	RAL 9011	Insulating material group	Illa
CTI	≥ 200	Insulation resistance	≥ 10 <sup>8</sup> Ω
UL 94 flammability rating	V-0	Contact material	Cu-Leg
Contact surface	tinned	Layer structure of plug contact	4-8 μm Sn hot-dip tinned
Storage temperature, min.	-25 °C	Storage temperature, max.	55 °C
Max. relative humidity during storage	80 %	Operating temperature, min.	-50 °C
Operating temperature, max.	100 °C	Temperature range, installation, min.	-30 °C
Temperature range, installation, max.	100 °C		

**Conductors suitable for connection**

Clamping range, rated connection, min.	0.08 mm <sup>2</sup>	Clamping range, rated connection, max.	1.5 mm <sup>2</sup>
Wire connection cross section AWG, min.	AWG 28	Wire connection cross section AWG, max.	AWG 14
Solid, min. H05(07) V-U	0.2 mm <sup>2</sup>	Solid, max. H05(07) V-U	1.5 mm <sup>2</sup>
Flexible, min. H05(07) V-K	0.2 mm <sup>2</sup>	Flexible, max. H05(07) V-K	1.5 mm <sup>2</sup>
w. plastic collar ferrule, DIN 46228 pt 4, min.	0.2 mm <sup>2</sup>	w. plastic collar ferrule, DIN 46228 pt 4, max.	1.5 mm <sup>2</sup>
w. wire end ferrule, DIN 46228 pt 1, min.	0.2 mm <sup>2</sup>	w. wire end ferrule, DIN 46228 pt 1, max.	1.5 mm <sup>2</sup>
Plug gauge acc. to EN 60999 a x b; Ø	2.4 mm x 1.5 mm		

## OMNIMATE Signal - series BL/SL 3.50 BL 3.50/24/90 SN BK BX

**Weidmüller Interface GmbH & Co. KG**  
Klingenbergstraße 16  
D-32758 Detmold  
Germany  
Fon: +49 5231 14-0  
Fax: +49 5231 14-292083  
www.weidmueller.com

## Technical data

### Rated data acc. to IEC

tested acc. to standard	IEC 60664-1, IEC 61984	Rated current, min. no. of poles (Ta = 20°C)	12 A
Rated current, max. no. of poles (Ta = 20°C)	10 A	Rated current, min. no. of poles (Ta = 40°C)	10 A
Rated current, max. no. of poles (Ta = 40°C)	8 A	Rated voltage for surge voltage class / pollution degree II/2	320 V
Rated voltage for surge voltage class / pollution degree III/2	160 V	Rated voltage for surge voltage class / pollution degree III/3	160 V
Rated impulse voltage for surge voltage class/ pollution degree II/2	2.5 kV	Rated impulse voltage for surge voltage class/ pollution degree III/2	2.5 kV
Rated impulse voltage for surge voltage class/ contamination degree III/3	2.5 kV	Short-time withstand current resistance	3 x 1s with 100 A

### Rated data acc. to CSA

Institute (CSA)		Certificate No. (CSA)	154685-1318353
Rated voltage (Use group B)	300 V	Rated voltage (use group D)	300 V
Rated current (use group B)	10 A	Rated current (use group D)	10 A
Wire cross-section, AWG, min.	AWG 28	Wire cross-section, AWG, max.	AWG 14
Reference to approval values	Specifications are maximum values, details - see approval certificate.		

### Rated data acc. to UL 1059

Institute (UR)		Certificate No. (UR)	E60693
Rated voltage (use group B)	300 V	Rated voltage (use group D)	300 V
Rated current (use group B)	8 A	Rated current (use group D)	8 A
Wire cross-section, AWG, min.	AWG 28	Wire cross-section, AWG, max.	AWG 14
Reference to approval values	Specifications are maximum values, details - see approval certificate.		

### Classifications

ETIM 3.0	EC001284	ETIM 4.0	EC002637
ETIM 5.0	EC002637	ETIM 6.0	EC002637
UNSPSC	30-21-18-10	eClass 5.1	27-26-07-04
eClass 6.2	27-26-07-04	eClass 7.1	27-44-04-02
eClass 8.1	27-44-04-02	eClass 9.0	27-44-04-02

**Data sheet**

**OMNIMATE Signal - series BL/SL 3.50  
BL 3.50/24/90 SN BK BX**

**Weidmüller Interface GmbH & Co. KG**  
Klingenbergstraße 16  
D-32758 Detmold  
Germany  
Fon: +49 5231 14-0  
Fax: +49 5231 14-292083  
www.weidmueller.com

**Technical data**

**Notes**

Notes	<ul style="list-style-type: none"> <li>• Additional colours on request</li> <li>• Gold-plated contact surfaces on request</li> <li>• Rated current related to rated cross-section &amp; min. No. of poles.</li> <li>• Max. outer diameter of the conductor: 2.9 mm</li> <li>• Wire end ferrule without plastic collar to DIN 46228/1</li> <li>• Wire end ferrule with plastic collar to DIN 46228/4</li> <li>• P on drawing = pitch</li> <li>• Rated data refer only to the component itself. Clearance and creepage distances to other components are to be designed in accordance with the relevant application standards.</li> </ul>
IPC conformity	The products are developed, manufactured and delivered according to the internationally recognised IPC-A-610 standard, category "permissible". More extensive demands on the products can be evaluated on request.

**Approvals**

Approvals



ROHS

Conform

**Downloads**

Safety notice [Safety indication](#)  
[3-D model](#)

**OMNIMATE Signal - series BL/SL 3.50  
BL 3.50/24/90 SN BK BX**

**Weidmüller Interface GmbH & Co. KG**  
Klingenbergstraße 16  
D-32758 Detmold  
Germany  
Fon: +49 5231 14-0  
Fax: +49 5231 14-292083  
www.weidmueller.com

**Drawings**

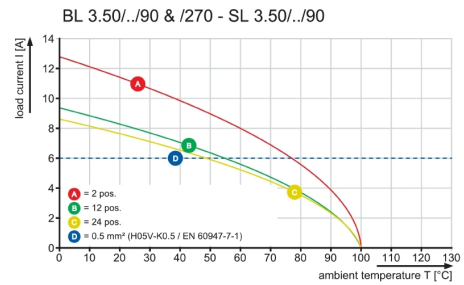
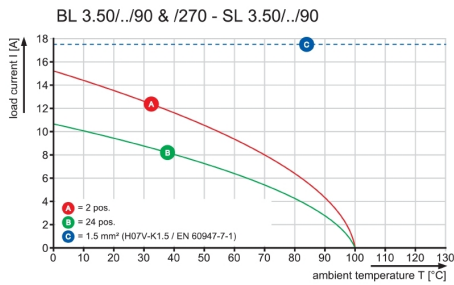
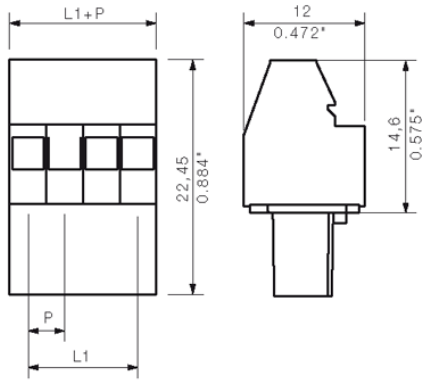

## OMNIMATE Signal - series BL/SL 3.50 BL 3.50/24/90 SN BK BX

**Weidmüller Interface GmbH & Co. KG**  
Klingenbergstraße 16  
D-32758 Detmold  
Germany  
Fon: +49 5231 14-0  
Fax: +49 5231 14-292083  
www.weidmueller.com

### Mating connector (conditionally pluggable)

#### SL-SMT 3.5/180F Box



**High-temperature-resistant male header, 3.50 mm pitch.**

- **Plugging direction parallel (90°), straight 180° or angled (135°) to PCB**
- **Housing variants: closed side (G), screw flange (F), solder flange (LF) or snap-on solder flange (RF)**
- **Optimised for the SMT process**
- **Pin length 3.2 mm universal for all soldering methods**
- **Pin length 1.5 mm optimised for reflow soldering methods**
- **Packed either in a box (BX) or tape-on-reel (RL)**
- **Male header can be coded**

#### General ordering data

Type	Order No.	Version	GTIN (EAN)	Qty.	Product data	Packaging
SL-SMT	<a href="#">1842990000</a>	PCB plug-in connector, male	4032248354450	20 pc(s).	IEC: 320 V / 15 A	Box
3.50/24/180F		header, Flange, THT/THR			UL: 300 V / 10 A	
3.2SN BK BX		solder connection, 3.50 mm, No. of poles: 24, 180°, Solder pin length (l): 3.2 mm, tinned, Black, Box				

#### SL-SMT 3.5/90LF Box



**High-temperature-resistant male header, 3.50 mm pitch.**

- **Plugging direction parallel (90°), straight 180° or angled (135°) to PCB**
- **Housing variants: closed side (G), screw flange (F), solder flange (LF) or snap-on solder flange (RF)**
- **Optimised for the SMT process**
- **Pin length 3.2 mm universal for all soldering methods**
- **Pin length 1.5 mm optimised for reflow soldering methods**
- **Packed either in a box (BX) or tape-on-reel (RL)**
- **Male header can be coded**

#### General ordering data

Type	Order No.	Version	GTIN (EAN)	Qty.	Product data	Packaging
SL-SMT	<a href="#">1805160000</a>	PCB plug-in connector, male	4032248269068	20 pc(s).	IEC: 320 V / 15 A	Box
3.50/24/90LF		header, Solder flange, THT/THR solder connection,			UL: 300 V / 10 A	
1.5SN BK BX		3.50 mm, No. of poles: 24,				

Creation date May 6, 2016 1:40:55 AM CEST

**OMNIMATE Signal - series BL/SL 3.50  
BL 3.50/24/90 SN BK BX**

**Weidmüller Interface GmbH & Co. KG**  
Klingenbergstraße 16  
D-32758 Detmold  
Germany  
Fon: +49 5231 14-0  
Fax: +49 5231 14-292083  
www.weidmueller.com

**Mating connector (conditionally pluggable)**

		90°, Solder pin length (l): 1.5 mm, tinned, Black, Box		
SL-SMT	<a href="#">1842070000</a>	PCB plug-in connector, male	4032248353422 20 pc(s).	IEC: 320 V / 15 A UL: 300 V / 10 A
3.50/24/90LF		header, Solder flange, THT/ THR solder connection,		Box
3.2SN BK BX		3.50 mm, No. of poles: 24, 90°, Solder pin length (l): 3.2 mm, tinned, Black, Box		

**SL-SMT 3.5/180G Box**

**High-temperature-resistant male header, 3.50 mm pitch.**

- **Plugging direction parallel (90°), straight 180° or angled (135°) to PCB**
- **Housing variants: closed side (G), screw flange (F), solder flange (LF) or snap-on solder flange (RF)**
- **Optimised for the SMT process**
- **Pin length 3.2 mm universal for all soldering methods**
- **Pin length 1.5 mm optimised for reflow soldering methods**
- **Packed either in a box (BX) or tape-on-reel (RL)**
- **Male header can be coded**

**General ordering data**

Type	Order No.	Version	GTIN (EAN)	Qty.	Product data	Packaging
SL-SMT	<a href="#">1842530000</a>	PCB plug-in connector, male	4032248353897 20 pc(s).		IEC: 320 V / 15 A UL: 300 V / 10 A	Box
3.50/24/180G		header, closed side, THT/ THR solder connection,				
3.2SN BK BX		3.50 mm, No. of poles: 24, 180°, Solder pin length (l): 3.2 mm, tinned, Black, Box				
SL-SMT	<a href="#">1753202001</a>	PCB plug-in connector, male	4032248131105 20 pc(s).		IEC: 320 V / 15 A UL: 300 V / 10 A	Box
3.50/24/180G		header, closed side, THT/ THR solder connection,				
1.5SN BK BX		3.50 mm, No. of poles: 24, 180°, Solder pin length (l): 1.5 mm, tinned, Black, Box				

**OMNIMATE Signal - series BL/SL 3.50  
BL 3.50/24/90 SN BK BX**

**Weidmüller Interface GmbH & Co. KG**  
Klingenbergstraße 16  
D-32758 Detmold  
Germany  
Fon: +49 5231 14-0  
Fax: +49 5231 14-292083  
www.weidmueller.com

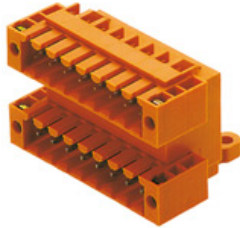
**Mating connector (conditionally pluggable)**
**SLD 3.50/90F**

Two-tier pin header for wave soldering in 3.50 mm pitch. The connector is available in open, closed and flange versions. The male connectors provide space for labelling and can be coded. Packed in a cardboard box.

**General ordering data**

Type	Order No.	Version	GTIN (EAN)	Qty.	Product data	Packaging
SLD 3.50/48/90F 3.2SN OR BX	<a href="#">1634030000</a>	PCB plug-in connector, male header, Flange, THT solder connection, 3.50 mm, No. of poles: 48, 90°, Solder pin length (l): 3.2 mm, tinned, Orange, Box	4008190258481	10 pc(s).	IEC: 200 V / 10.5 A UL: 300 V / 8 A	Box

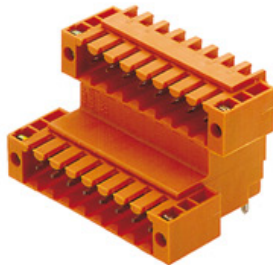
**SLD 3.50V/90F**

Double-level, staggered pin header for wave soldering at 3.50 mm pitch. They are available in closed and flanged versions. The male connectors provide space for labelling and can be coded.

**General ordering data**

Type	Order No.	Version	GTIN (EAN)	Qty.	Product data	Packaging
SLD 3.50 V/48/90F 3.2 SN OR BX	<a href="#">1642480000</a>	PCB plug-in connector, male header, Flange, THT solder connection, 3.50 mm, No. of poles: 48, 90°, Solder pin length (l): 3.2 mm, tinned, Orange, Box	4008190281007	10 pc(s).	IEC: 200 V / 10.5 A UL: 300 V / 8 A	Box

**OMNIMATE Signal - series BL/SL 3.50  
BL 3.50/24/90 SN BK BX**

**Weidmüller Interface GmbH & Co. KG**  
Klingenbergstraße 16  
D-32758 Detmold  
Germany  
Fon: +49 5231 14-0  
Fax: +49 5231 14-292083  
www.weidmueller.com

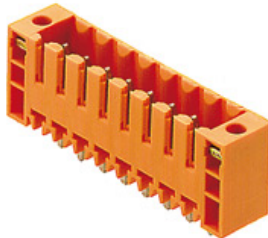
**Mating connector (conditionally pluggable)**
**SL 3.50/180F**

Pin headers for wave soldering in 3.50 mm pitch

- Plugging direction is parallel (90°), straight 180° or angled (135°) to the PCB
- Housing variant: screw flange (F)
- Packed in a cardboard box (BX)
- Pin header can be coded

**General ordering data**

Type	Order No.	Version	GTIN (EAN)	Qty.	Product data	Packaging
SL 3.50/24/180F 3.2SN OR BX	<a href="#">1622250000</a>	PCB plug-in connector, male header, Flange, THT solder connection, 3.50 mm, No. of poles: 24, 180°, Solder pin length (l): 3.2 mm, tinned, Orange, Box	4008190189723	20 pc(s).	IEC: 320 V / 17 A UL: 300 V / 10 A	Box

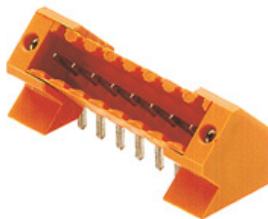
**SL 3.50/135F**

Pin headers for wave soldering in 3.50 mm pitch

- Plugging direction is parallel (90°), straight 180° or angled (135°) to the PCB
- Housing variant: screw flange (F)
- Packed in a cardboard box (BX)
- Pin header can be coded

**General ordering data**

Type	Order No.	Version	GTIN (EAN)	Qty.	Product data	Packaging
SL 3.50/24/135F 3.2SN OR BX	<a href="#">1643550000</a>	PCB plug-in connector, male header, Flange, THT solder connection, 3.50 mm, No. of poles: 24, 135°, Solder pin length (l): 3.2 mm, tinned, Orange, Box	4008190282318	20 pc(s).	IEC: 320 V / 15 A UL: 300 V / 10 A	Box

**OMNIMATE Signal - series BL/SL 3.50  
BL 3.50/24/90 SN BK BX**

**Weidmüller Interface GmbH & Co. KG**  
 Klingenbergstraße 16  
 D-32758 Detmold  
 Germany  
 Fon: +49 5231 14-0  
 Fax: +49 5231 14-292083  
 www.weidmueller.com

**Mating connector (conditionally pluggable)****SL-SMT 3.5/180LF Box**

**High-temperature-resistant male header, 3.50 mm pitch.**

- **Plugging direction parallel (90°), straight 180° or angled (135°) to PCB**
- **Housing variants: closed side (G), screw flange (F), solder flange (LF) or snap-on solder flange (RF)**
- **Optimised for the SMT process**
- **Pin length 3.2 mm universal for all soldering methods**
- **Pin length 1.5 mm optimised for reflow soldering methods**
- **Packed either in a box (BX) or tape-on-reel (RL)**
- **Male header can be coded**

**General ordering data**

Type	Order No.	Version	GTIN (EAN)	Qty.	Product data	Packaging
SL-SMT 3.50/24/180LF 1.5SN BK BX	<a href="#">1804930000</a>	PCB plug-in connector, male header, Solder flange, THT/ THR solder connection, 3.50 mm, No. of poles: 24, 180°, Solder pin length (l): 1.5 mm, tinned, Black, Box	4032248268696	20 pc(s).	IEC: 320 V / 15 A UL: 300 V / 10 A	Box
SL-SMT 3.50/24/180LF 3.2SN BK BX	<a href="#">1842760000</a>	PCB plug-in connector, male header, Solder flange, THT/ THR solder connection, 3.50 mm, No. of poles: 24, 180°, Solder pin length (l): 3.2 mm, tinned, Black, Box	4032248354122	20 pc(s).	IEC: 320 V / 15 A UL: 300 V / 10 A	Box

**OMNIMATE Signal - series BL/SL 3.50  
BL 3.50/24/90 SN BK BX**

**Weidmüller Interface GmbH & Co. KG**  
Klingenbergstraße 16  
D-32758 Detmold  
Germany  
Fon: +49 5231 14-0  
Fax: +49 5231 14-292083  
www.weidmueller.com

**Mating connector (conditionally pluggable)**
**SL-SMT 3.5/90F Box**

**High-temperature-resistant male header, 3.50 mm pitch.**

- **Plugging direction parallel (90°), straight 180° or angled (135°) to PCB**
- **Housing variants: closed side (G), screw flange (F), solder flange (LF) or snap-on solder flange (RF)**
- **Optimised for the SMT process**
- **Pin length 3.2 mm universal for all soldering methods**
- **Pin length 1.5 mm optimised for reflow soldering methods**
- **Packed either in a box (BX) or tape-on-reel (RL)**
- **Male header can be coded**

**General ordering data**

Type	Order No.	Version	GTIN (EAN)	Qty.	Product data	Packaging
SL-SMT	<a href="#">1842300000</a>	PCB plug-in connector, male	4032248353651	20 pc(s).	IEC: 320 V / 15 A UL: 300 V / 10 A	Box
3.50/24/90F		header, Flange, THT/THR				
3.2SN BK BX		solder connection, 3.50 mm, No. of poles: 24, 90°, Solder pin length (l): 3.2 mm, tinned, Black, Box				

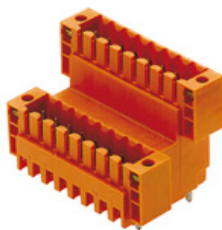
**SLD 3.50V/180F**

Double-level, staggered pin header for wave soldering at 3.50 mm pitch. They are available in closed and flanged versions. The male connectors provide space for labelling and can be coded.

**General ordering data**

Type	Order No.	Version	GTIN (EAN)	Qty.	Product data	Packaging
SLD 3.50	<a href="#">1641350000</a>	PCB plug-in connector, male header, Flange, THT	4008190279752	10 pc(s).	IEC: 200 V / 10.5 A UL: 300 V / 8 A	Box
V/48/180F		solder connection, 3.50 mm, No. of poles: 48, 180°, Solder pin length (l): 3.2 mm, tinned, Orange, Box				

**OMNIMATE Signal - series BL/SL 3.50  
BL 3.50/24/90 SN BK BX**

**Weidmüller Interface GmbH & Co. KG**  
 Klingenbergstraße 16  
 D-32758 Detmold  
 Germany  
 Fon: +49 5231 14-0  
 Fax: +49 5231 14-292083  
 www.weidmueller.com

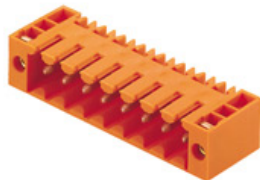
**Mating connector (conditionally pluggable)**
**SL 3.50/90F**

Pin headers for wave soldering in 3.50 mm pitch

- Plugging direction is parallel (90°), straight 180° or angled (135°) to the PCB
- Housing variant: screw flange (F)
- Packed in a cardboard box (BX)
- Pin header can be coded

**General ordering data**

Type	Order No.	Version	GTIN (EAN)	Qty.	Product data	Packaging
SL	<a href="#">1619840000</a>	PCB plug-in connector, male	4008190147679	20 pc(s).	IEC: 320 V / 17 A	Box
3.50/24/90F		header, Flange, THT solder			UL: 300 V / 10 A	
3.2SN OR BX		connection, 3.50 mm, No. of poles: 24, 90°, Solder pin length (l): 3.2 mm, tinned, Orange, Box				

**OMNIMATE Signal - series BL/SL 3.50  
BL 3.50/24/90 SN BK BX**

**Weidmüller Interface GmbH & Co. KG**  
Klingenbergstraße 16  
D-32758 Detmold  
Germany  
Fon: +49 5231 14-0  
Fax: +49 5231 14-292083  
www.weidmueller.com

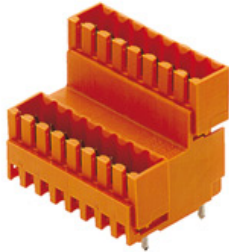
**Mating connector (fully pluggable)**
**SLD 3.50V/180G**

Double-level, staggered pin header for wave soldering at 3.50 mm pitch. They are available in closed and flanged versions. The male connectors provide space for labelling and can be coded.

**General ordering data**

Type	Order No.	Version	GTIN (EAN)	Qty.	Product data	Packaging
SLD	<a href="#">1641220000</a>	PCB plug-in connector, male	4008190279622	10 pc(s).	IEC: 200 V / 10.5 A	Box
3.50V/48/180G		header, closed side, THT			UL: 300 V / 8 A	
3.2SN OR BX		solder connection, 3.50 mm, No. of poles: 48, 180°, Solder pin length (l): 3.2 mm, tinned, Orange, Box				

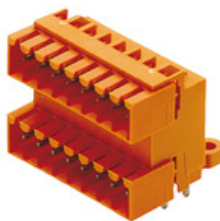
**SLD 3.50/90G**

Two-tier pin header for wave soldering in 3.50 mm pitch. The connector is available in open, closed and flange versions. The male connectors provide space for labelling and can be coded. Packed in a cardboard box.

**General ordering data**

Type	Order No.	Version	GTIN (EAN)	Qty.	Product data	Packaging
SLD	<a href="#">1633800000</a>	PCB plug-in connector, male	4008190258252	10 pc(s).	IEC: 200 V / 10.5 A	Box
3.50/48/90G		header, closed side, THT			UL: 300 V / 8 A	
3.2SN OR BX		solder connection, 3.50 mm, No. of poles: 48, 90°, Solder pin length (l): 3.2 mm, tinned, Orange, Box				

**OMNIMATE Signal - series BL/SL 3.50**  
**BL 3.50/24/90 SN BK BX**

**Weidmüller Interface GmbH & Co. KG**  
 Klingenbergstraße 16  
 D-32758 Detmold  
 Germany  
 Fon: +49 5231 14-0  
 Fax: +49 5231 14-292083  
 www.weidmueller.com

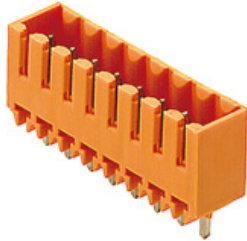
**Mating connector (fully pluggable)****SL 3.50/180G**

Pin headers for wave soldering in 3.50 mm pitch

- Plugging direction is parallel (90°), straight 180° or angled (135°) to the PCB
- Housing variant: screw flange (F)
- Packed in a cardboard box (BX)
- Pin header can be coded

**General ordering data**

Type	Order No.	Version	GTIN (EAN)	Qty.	Product data	Packaging
SL	<a href="#">1621860000</a>	PCB plug-in connector, male	4008190182076	20 pc(s).	IEC: 320 V / 17 A UL: 300 V / 10 A	Box
3.50/24/180G		header, closed side, THT				
3.2SN OR BX		solder connection, 3.50 mm, No. of poles: 24, 180°, Solder pin length (l): 3.2 mm, tinned, Orange, Box				

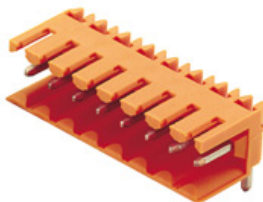
**SL 3.50/90**

Pin headers for wave soldering in 3.50 mm pitch

- Plugging direction is parallel (90°), straight 180° or angled (135°) to the PCB
- Housing variant: screw flange (F)
- Packed in a cardboard box (BX)
- Pin header can be coded

**General ordering data**

Type	Order No.	Version	GTIN (EAN)	Qty.	Product data	Packaging
SL	<a href="#">1619060000</a>	PCB plug-in connector, male	4008190133047	20 pc(s).	IEC: 320 V / 17 A UL: 300 V / 10 A	Box
3.50/24/90		header, open side, THT				
3.2SN OR BX		solder connection, 3.50 mm, No. of poles: 24, 90°, Solder pin length (l): 3.2 mm, tinned, Orange, Box				

**OMNIMATE Signal - series BL/SL 3.50  
BL 3.50/24/90 SN BK BX**

**Weidmüller Interface GmbH & Co. KG**  
Klingenbergstraße 16  
D-32758 Detmold  
Germany  
Fon: +49 5231 14-0  
Fax: +49 5231 14-292083  
www.weidmueller.com

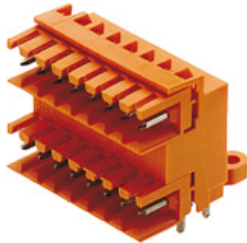
**Mating connector (fully pluggable)**
**SLD 3.50/90**

Two-tier pin header for wave soldering in 3.50 mm pitch. The connector is available in open, closed and flange versions. The male connectors provide space for labelling and can be coded. Packed in a cardboard box.

**General ordering data**

Type	Order No.	Version	GTIN (EAN)	Qty.	Product data	Packaging
SLD	<a href="#">1633570000</a>	PCB plug-in connector, male	4008190258023	10 pc(s).	IEC: 200 V / 10.5 A UL: 300 V / 8 A	Box
3.50/48/90		header, open side, THT				
3.2SN OR BX		solder connection, 3.50 mm, No. of poles: 48, 90°, Solder pin length (l): 3.2 mm, tinned, Orange, Box				

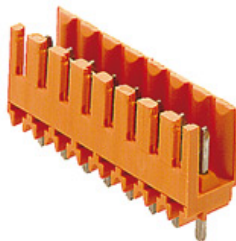
**SL 3.50/180**

Pin headers for wave soldering in 3.50 mm pitch

- Plugging direction is parallel (90°), straight 180° or angled (135°) to the PCB
- Housing variant: screw flange (F)
- Packed in a cardboard box (BX)
- Pin header can be coded

**General ordering data**

Type	Order No.	Version	GTIN (EAN)	Qty.	Product data	Packaging
SL	<a href="#">1621470000</a>	PCB plug-in connector, male	4008190173890	20 pc(s).	IEC: 320 V / 17 A UL: 300 V / 10 A	Box
3.50/24/180		header, open side, THT				
3.2SN OR BX		solder connection, 3.50 mm, No. of poles: 24, 180°, Solder pin length (l): 3.2 mm, tinned, Orange, Box				

**OMNIMATE Signal - series BL/SL 3.50  
BL 3.50/24/90 SN BK BX**

**Weidmüller Interface GmbH & Co. KG**  
Klingenbergstraße 16  
D-32758 Detmold  
Germany  
Fon: +49 5231 14-0  
Fax: +49 5231 14-292083  
www.weidmueller.com

**Mating connector (fully pluggable)**
**SL-THR 3.5/135F**

**High-temperature-resistant male header, 3.50 mm pitch.**

- **Plugging direction parallel (90°), straight 180° or angled (135°) to PCB**
- **Housing variants: closed side (G), screw flange (F), solder flange (LF) or snap-on solder flange (RF)**
- **Optimised for the SMT process**
- **Pin length 3.2 mm universal for all soldering methods**
- **Pin length 1.5 mm optimised for reflow soldering methods**
- **Packed either in a box (BX) or tape-on-reel (RL)**
- **Male header can be coded**

**General ordering data**

Type	Order No.	Version	GTIN (EAN)	Qty.	Product data	Packaging
SL-SMT	<a href="#">1003740000</a>	PCB plug-in connector, male	4032248700363	20 pc(s).	IEC: 320 V / 15 A UL: 300 V / 10 A	Box
3.50/24/135F		header, Flange, THT/THR				
3.2SN BK BX		solder connection, 3.50 mm, No. of poles: 24, 135°, Solder pin length (l): 3.2 mm, tinned, Black, Box				

**SLD 3.50V/90G**



Double-level, staggered pin header for wave soldering at 3.50 mm pitch. They are available in closed and flanged versions. The male connectors provide space for labelling and can be coded.

**General ordering data**

Type	Order No.	Version	GTIN (EAN)	Qty.	Product data	Packaging
SLD	<a href="#">1642350000</a>	PCB plug-in connector, male	4008190280871	10 pc(s).	IEC: 200 V / 10.5 A UL: 300 V / 8 A	Box
3.50V/48/90G		header, closed side, THT				
3.2SN OR BX		solder connection, 3.50 mm, No. of poles: 48, 90°, Solder pin length (l): 3.2 mm, tinned, Orange, Box				

**OMNIMATE Signal - series BL/SL 3.50  
BL 3.50/24/90 SN BK BX**

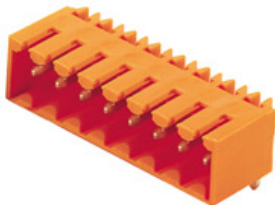
**Weidmüller Interface GmbH & Co. KG**  
Klingenbergstraße 16  
D-32758 Detmold  
Germany  
Fon: +49 5231 14-0  
Fax: +49 5231 14-292083  
www.weidmueller.com

**Mating connector (fully pluggable)**
**SL 3.50/90G**

Pin headers for wave soldering in 3.50 mm pitch

- Plugging direction is parallel (90°), straight 180° or angled (135°) to the PCB
- Housing variant: screw flange (F)
- Packed in a cardboard box (BX)
- Pin header can be coded

**General ordering data**

Type	Order No.	Version	GTIN (EAN)	Qty.	Product data	Packaging
SL	<a href="#">1619450000</a>	PCB plug-in connector, male	4008190140137	20 pc(s).	IEC: 320 V / 17 A UL: 300 V / 10 A	Box
3.50/24/90G		header, closed side, THT				
3.2SN OR BX		solder connection, 3.50 mm, No. of poles: 24, 90°, Solder pin length (l): 3.2 mm, tinned, Orange, Box				

**SL-SMT 3.5/90G Box**

**High-temperature-resistant male header, 3.50 mm pitch.**

- **Plugging direction parallel (90°), straight 180° or angled (135°) to PCB**
- **Housing variants: closed side (G), screw flange (F), solder flange (LF) or snap-on solder flange (RF)**
- **Optimised for the SMT process**
- **Pin length 3.2 mm universal for all soldering methods**
- **Pin length 1.5 mm optimised for reflow soldering methods**
- **Packed either in a box (BX) or tape-on-reel (RL)**
- **Male header can be coded**

**General ordering data**

Type	Order No.	Version	GTIN (EAN)	Qty.	Product data	Packaging
SL-SMT	<a href="#">1761762001</a>	PCB plug-in connector, male	4032248132355	20 pc(s).	IEC: 320 V / 15 A UL: 300 V / 10 A	Box
3.50/24/90G		header, closed side, THT/THR solder connection,				
1.5SN BK BX		3.50 mm, No. of poles: 24, 90°, Solder pin length (l): 1.5 mm, tinned, Black, Box				
SL-SMT	<a href="#">1841850000</a>	PCB plug-in connector, male	4032248353200	20 pc(s).	IEC: 320 V / 15 A UL: 300 V / 10 A	Box
3.50/24/90G		header, closed side, THT/THR solder connection,				
3.2SN BK BX		3.50 mm, No. of poles: 24,				

**OMNIMATE Signal - series BL/SL 3.50  
BL 3.50/24/90 SN BK BX**

**Weidmüller Interface GmbH & Co. KG**  
Klingenbergstraße 16  
D-32758 Detmold  
Germany  
Fon: +49 5231 14-0  
Fax: +49 5231 14-292083  
[www.weidmueller.com](http://www.weidmueller.com)

**Mating connector (fully pluggable)**

90°, Solder pin length (l):  
3.2 mm, tinned, Black, Box

# Addresses worldwide



Let's connect.

- AE United Arab Emirates**  
Weidmüller Middle East FZE  
Warehouse Q3-79  
SAIF-Zone  
P.O. BOX 8591  
Sharjah  
Telephone number +971 65572723  
Fax number +971 65572724  
wme.info@weidmueller.com
- AO Angola**  
Please contact  
Phambili Interface  
South Africa
- AR Argentina**  
CPI SA  
Bauness 2660  
C1431DOF Buenos Aires  
Telephone number +54 11 4523 8008  
Fax number +54 11 4522 0546  
info@cpi.com.ar  
www.cpi.com.ar
- AT Austria**  
Weidmüller GmbH  
IZ NOE Süd, Str 2b, Obj M59,  
2355 Wiener Neudorf  
Telephone number +43 2236 67080  
Fax number +43 2236 6708-899  
office.at@weidmueller.com  
www.weidmueller.com
- AU Australia**  
Weidmüller Pty. Ltd.  
PO BOX 6944  
Huntingwood 2148  
Huntingwood Drive 43  
Huntingwood NSW 2148  
Telephone number +61 2 9671 9999  
Fax number +61 2 9671 9911  
info@weidmuller.com.au  
www.weidmuller.com.au
- AZ Azerbaijan**  
Representative Office  
Weidmüller Interface  
Demirchi Tower, 4th floor  
37, Khojali ave.  
AZ 1025 Baku  
Telephone number +994 12 488 80 36  
Fax number +994 12 488 80 37  
aliyar.hashimli@weidmueller
- BA Bosnia and Herzegovina**  
Please contact  
our Representative Office  
Weidmüller Interface GmbH  
& Co. KG  
Serbia  
or  
BIG electric d.o.o  
Mladena Stojanovića 117A  
78000 Banja Luka  
Telephone number +387 51926277  
Fax number +387 51926277  
bigelectric@blic.net  
www.bigelectric.ba
- BE Belgium**  
Weidmüller Benelux B. V.  
Mechelsesteenweg 519 bus  
6 en 7  
1930 Nossegem  
Telephone number +32 2 752 40 70  
Fax number +32 2 751 36 06  
info@weidmueller.be  
www.weidmueller.be
- BG Bulgaria**  
Weid-Bul EOOD  
Bul. „Kliment Ohridski“ 13  
1756 Sofia  
Telephone number +359 2 963 2560  
Fax number +359 2 963 1098  
sofia@weidbul.com  
www.weidbul.com
- BH Bahrain**  
Khayber Trading Company  
P.O Box 1976  
Manama  
Telephone number +973 720747  
Fax number +973 720331  
khayber@batelco.com.bh
- BR Brazil**  
Weidmüller Conexel do Brasil  
Conexões Elétricas Ltda.  
Av. Presidente Juscelino, 642  
- Piraporinha  
Diadema, São Paulo  
09950-370  
Telephone number +55 (11) 4366-9600  
Fax number +55 (11) 4362-1677  
vendas@weidmueller.com.br  
www.weidmueller.com.br
- BW Botswana**  
Please contact  
Phambili Interface  
South Africa
- BY Belarus**  
TECHNIKON Ltd.  
Nezavisimosti pr. 177-9  
220125 Minsk  
Telephone number +375 17 393-11-77  
Fax number +375 17 3930080  
wm@technikon.by
- CA Canada**  
W Interconnections Canada  
Inc.  
10 Spy Court  
Markham Ontario L3R 5H6  
Telephone number +1 (905) 475-1507 Ext. 9836  
Fax number +1 (905) 475-2798  
support@weidmuller.ca  
www.weidmuller.ca
- CG Congo**  
Please contact  
Phambili Interface  
South Africa
- CH Switzerland**  
Weidmüller Schweiz AG  
Rundbuckstraße 2  
8212 Neuhausen am  
Rheinfall SH  
Telephone number +41 52 674 07 07  
Fax number +41 52 674 07 08  
info@weidmueller.ch  
www.weidmueller.ch
- CL Chile**  
ATS - INTECH  
María Luisa Santander 0475  
Santiago  
Providencia 7500859  
Telephone number +56 2 341 1271  
Fax number +56 2 341 1275  
felipe@atsintech.com  
www.atsintech.com  
CPI CHILE LTDA  
Av. Presidente Frei Montalva  
6001, 47 complejo el cortijo  
Santiago - Conchalí  
Telephone number +562 963 8440  
Fax number +562 963 8440  
cpi@cpichile.cl  
www.cpicchile.cl
- CN China**  
Weidmüller Interface  
(Shanghai) Co. Ltd.  
100 Yutong Road  
25 F, BM Intercontinental  
Business Center  
200070 Shanghai  
Telephone number +86 21-22195008  
Fax number +86 21-22195009  
customer.hotline@weidmueller.com.cn  
www.weidmueller.com.cn
- CO Colombia**  
Automatización Avanzada  
S. A.  
Carrera 97 No., 24 c - 23  
Bodega 4  
110911 Bogotá-D.C.  
Telephone number +57 (1) 547-8510  
Fax number +57 (1) 422-3044  
comercial@automatizacionavanzada.com  
www.automatizacionavanzada.com
- CR Costa Rica**  
ELVATRON S. A.  
la Uruca 400 Norte Banco  
Costa Rica  
San Jose Costa Rica  
Telephone number +506 2961-060  
Fax number +506 5200-609  
dirk.haase@elvatron.com  
www.elvatron.com
- CZ Czech Republic**  
Weidmüller s.r.o.  
Lomnického 5/1705  
140 00 Praha 4  
Telephone number +420 244 001 400  
Fax number +420 244 001 499  
office@weidmueller.cz  
www.weidmueller.cz
- DE Germany**  
Weidmüller GmbH & Co. KG  
Ohmstraße 9  
32758 Detmold  
Postfach 30 54  
32720 Detmold  
Telephone number +49 5231 1428-0  
Fax number +49 5231 14-292083  
weidmuller@weidmueller.de  
www.weidmueller.de
- DK Denmark**  
Weidmüller Danmark  
Vallensbækvej 18A  
2605 Brøndby  
Telephone number +45 27747800  
kundeservice@weidmuller.dk  
www.weidmuller.dk
- DZ Algeria**  
SARL INTER ELECTRIC  
1a Angles des Rues Okba Ibn  
Nafaa et Hassi Beida  
2300 Annaba  
Telephone number  
Fax number  
contact@inter-electric.com
- EC Ecuador**  
Elsystec S. A., Electricidad  
Sistemas y Tecnología  
Vasco de Contreras N35-251  
y Manosca  
Quito - Pichincha  
Telephone number +593 22456510  
Fax number +593 22456755  
Elsystec@uio.satnet.net
- EE Estonia**  
Please contact  
our Representative Office  
Weidmüller Interface GmbH  
& Co. KG  
Latvia  
or  
Soots Interface OÜ  
Pärnu mnt 142  
11317 Tallinn  
Telephone number +372 609 6933  
Fax number  
info@sootsinterface.ee  
www.sootsinterface.ee
- EG Egypt**  
Standard Electric (OMEGA)  
1, Abdelhamid Badawy Street  
Heliopolis  
Cairo  
Telephone number +202 21805111  
Fax number +202 21805600  
stdelec@rite.com
- ES Spain**  
Weidmüller, S. A.  
Narcís Monturiol 11-13, Pol.  
Ind. Sudoeste  
8960 Sant Just  
Desvern - Barcelona  
Telephone number +34 934 803 386  
Fax number +34 933 718 055  
weidmuller@weidmuller.es  
www.weidmuller.es
- FI Finland**  
Weidmüller Suomi,  
Weidmüller Aktiebolagetin  
sivuliike  
Koy Plaza Vivace  
Äyritie 8C  
FI 1510 Vantaa  
Telephone number +358 20 7351300  
Fax number +358 800 114 667  
asiakaspalvelu@weidmuller.fi  
www.weidmuller.fi
- FR France**  
Weidmüller E. U. R. L.  
12, Chaussée Jules César  
BP 263 Osny  
95523 Cergy-Pontoise Cedex  
Telephone number +33 1 34 24 55 00  
Fax number +33 1 34 24 55 01  
mail@weidmuller.fr
- GB Great Britain**  
Weidmüller Ltd.  
Klippon House  
Centurion Court Office Park,  
Meridian East, Meridian  
Business Park  
Leicester  
LE19 1TP  
Telephone number +44 116 282 3470  
Fax number +44 116 289 3582  
marketing@weidmuller.co.uk  
www.weidmuller.co.uk
- GE Georgia**  
Please contact  
our Representative Office  
Weidmüller Interface  
Azerbaijan.
- GH Ghana**  
Please contact  
our Representative Office  
Weidmüller Interface GmbH  
& Co. KG  
South Africa.
- GR Greece**  
G.A. Solutions  
Ippokratous 11 Metamorfosi  
144 52 Athen  
Telephone number +30 210 2823233  
Fax number +30 210 2823233  
info@weidmuller.gr  
www.weidmuller.gr
- GT Guatemala**  
Prestelectro, Prestegard  
Electro, S.A.  
Avenida Petapa 44-22,  
Zona 12  
Guatemala City  
Telephone number +502 2442-3346  
Fax number +502 2476-8945  
ventas@prestelectro.com
- HK Hong Kong**  
Weidmüller (Hong Kong)  
Limited Co. Ltd.  
Unit 1617, Metropolis Tower  
No. 10 Metropolis Drive,  
Hunghom, Kowloon  
Telephone number +852 3154 8088  
Fax number +852 31548099  
Info-hk@weidmueller.com.hk
- HR Croatia**  
ElektroPARTNER d.o.o.  
Slavonska avenija 24/6  
HR-10000 Zagreb  
Telephone number +385 (1) 6184 793  
Fax number +385 (1) 6184 795  
elektropartner@zg.t-com.hr  
www.elektropartner.hr
- HU Hungary**  
Weidmüller Kereskedelmi Kft.  
Budapest  
Gubacsi út 6.  
1097  
Telephone number +36 1 382 7700  
Fax number +36 1 382 7701  
info@weidmueller.hu  
www.weidmueller.hu
- ID Indonesia**  
PT. Nego Electrindo  
Ruko Mega Grosir Cempaka  
Mas Blok I No. 20 – 22  
Jakarta 10640  
Telephone number +62 21 42882255  
Fax number +62 21 42882266  
sales@negoelectrindo.co.id
- IE Ireland**  
Please contact  
Weidmüller Ltd.  
Great Britain
- IL Israel**  
A. U. Shay Ltd.  
23/25, Embarr Street  
49222 Petach-Tikva  
P.O. Box 1 00 49  
49222 Petach-Tikva  
Telephone number +972 3-923-3601  
Fax number +972 3-923-4601  
shay@uriel-shay.com  
www.uriel-shay.com  
ATEKA Ltd.  
4, Ha Tavor lane Industrial  
area Segula  
49691 Petach-Tikva  
P.O. Box 4710  
Petach-Tikva  
Telephone number +972 73-200-1311  
Fax number +972 3-924 4245  
marketing@ateka.co.il  
www.ateka.co.il
- IN India**  
Representative Office  
Weidmüller Electronics India  
Pvt. Ltd.  
No. 9, Union Street, Off.  
Infantry Road  
BANGALORE  
560 001  
Telephone number +91-80-22860028  
wmi@weidmueller.in  
www.weidmueller.com
- IR Iran**  
Representative Office  
Tamin Ehtiajat Fanni Tehran  
(TAF Co.)  
Unit #. 5, No. 62 Iranshahr  
Ave.  
Tehran - 15816-53717, Iran  
Telephone number +9821 8831 7851  
info@taf-co.com  
http://www.taf-co.com
- IS Iceland**  
Samey Automation Center  
Lyngas 13  
210 Garoabaer  
Telephone number +354 510 5200  
Fax number +354 5 10 5201  
Samey@samey.is  
www.samey.is
- IT Italy**  
Weidmüller S. r.l.  
Via Albert Einstein 4  
20092 Cinisello  
Balsamo Milano  
Telephone number +39 02 660681  
Fax number +39 02 6124945  
weidmuller@weidmueller.it  
www.weidmueller.it
- JM Jamaica**  
Please contact  
W Interconnections Inc.  
United States



You can find all Weidmüller addresses and your local contact on the internet at: [www.weidmuller.com/countries](http://www.weidmuller.com/countries)

Let's connect.

Sales company   
Representation abroad   
without representation abroad 

- JO Jordan**  
Trans Jordan for Electro  
PO Box 33 06 07  
Amman  
Telephone number +962 6 533 2020  
Fax number +962 6 533 5800  
[transjordan@batelco.jo](mailto:transjordan@batelco.jo)
- JP Japan**  
Nihon Weidmüller Co. Ltd.  
Sphere Tower Tennoz 2-2-8  
Higashi-Shinagawa,  
Shinagawa-ku  
Tokyo  
140-0002  
Telephone number +81 3 6711 5300  
Fax number +81 3 6711 5333  
[weidmullerjapan@weidmuller.co.jp](mailto:weidmullerjapan@weidmuller.co.jp)  
[www.weidmuller.co.jp](http://www.weidmuller.co.jp)
- KE Kenya**  
Please contact our Representative Office Weidmüller Interface GmbH & Co. KG South Africa.
- KG Kyrgyzstan**  
Please contact our Representative Office Weidmüller Interface Azerbaijan.
- KR Korea**  
Weidmuller Korea Co. Ltd.  
9th floor  
429, Teheran-ro, Gangnam-Gu  
Seoul 135-721  
Telephone number +82 2-516-0003  
Fax number +82 2-516-0090  
[info@weidmuller.co.kr](mailto:info@weidmuller.co.kr)  
[www.weidmuller.co.kr](http://www.weidmuller.co.kr)
- KW Kuwait**  
Kana Controls General Trading & Contracting Co. W. L. L.  
Al Rai Industrial Area, Plot 28-30, St. 31  
13016 Safat  
B.P. 25593  
Telephone number +965 4741373  
Fax number +965 4741537  
[info@kanacontrols.com](mailto:info@kanacontrols.com)
- KZ Kazakhstan**  
Please contact Weidmüller Group Russia
- LB Lebanon**  
Progress Engineering & Trading Enterprises  
Al Nahr Street  
Beirut 11-1111  
Telephone number +961 1 444 664  
Fax number +961 1 561 880  
[progress@inco.com.lb](mailto:progress@inco.com.lb)
- LT Lithuania**  
Please contact our Representative Office Weidmüller Interface GmbH & Co. KG Latvia  
or  
ELEKTROS IRANGA  
Tinklų g. 29 a  
LT-5319 Panevezys  
Telephone number +370 (45) 582 828  
Fax number  
[info@eliranga.lt](mailto:info@eliranga.lt)
- LU Luxembourg**  
Please contact Weidmüller Benelux B. V. Netherlands
- LV Latvia**  
SIA Abi4  
Daugavgrivas 31b  
Riga, LV-1007  
Telephone number +371 674 70999  
Fax number +371 676 24562  
[abi\\_4@tvnet.lv](mailto:abi_4@tvnet.lv)  
Representative Office Weidmüller Interface GmbH & Co. KG  
Udens str. 12-118  
Riga, LV-1007  
Telephone number +371 29254766  
Fax number +371 674 65637  
[Ilgonis.rudaks@weidmuller.com](mailto:Ilgonis.rudaks@weidmuller.com)  
[www.weidmuller.com](http://www.weidmuller.com)
- MA Morocco**  
Sofimed  
137, Bd Moulay Ismail Roches Noires  
20290 Casablanca  
Telephone number  
Fax number  
[contact@sofimedmaroc.com](mailto:contact@sofimedmaroc.com)
- MD Moldova**  
BERHORD A & D srl  
79/1, str. Milescu Spartaru  
MD-2075 Chisinau  
Moldova  
Telephone number +373 (22) 815002  
Fax number +373 (22) 815007  
[atiuleanu@berhord.com](mailto:atiuleanu@berhord.com)  
[www.ad.berhord.com](http://www.ad.berhord.com)
- ME Montenegro**  
Please contact our Representative Office Weidmüller Interface GmbH & Co. KG Serbia.
- MG Madagascar**  
Please contact Phambili Interface South Africa
- MK Macedonia**  
Please contact our Representative Office Weidmüller Interface GmbH & Co. KG Serbia  
or  
ELEKTRO - SMK doool  
UL. III Makedonska brigada  
b.b.  
1000 Skopje  
Telephone number +389 22460295  
Fax number  
[Elektro-smk@telelab.net.mk](mailto:Elektro-smk@telelab.net.mk)
- MN Mongolia**  
Please contact our Representative Office Weidmüller Interface Azerbaijan.
- MT Malta**  
E. S. S., Electrical Supplies & Services Ltd.  
San Gwakklin Road  
Mriehel  
Telephone number +356 21255777  
Fax number +356 21255999  
[robert.agius@ess.com.mt](mailto:robert.agius@ess.com.mt)
- MU Mauritius**  
Mubelo Electrical Ltd.  
Office 26, Gateway building,  
St Jean Road  
Quatre Bornes  
Mauritius  
Telephone number +230 4670989  
Fax number +230 4654051  
[richard.mubelo@orange.mu](mailto:richard.mubelo@orange.mu)
- MW Malawi**  
Please contact our Representative Office Weidmüller Interface GmbH & Co. KG South Africa.
- MX Mexico**  
W Interconnections S. A.  
DE C. V.  
Blvd. Hermanos Sardan 698,  
Col. San Rafael Oriente  
72029 Puebla  
Telephone number +52 (222) 268 6227  
Fax number +52 (222) 286 6242  
[clientes@weidmuller.com.mx](mailto:clientes@weidmuller.com.mx)
- MY Malaysia**  
Connect Plus Technology  
Sdn Bhd  
No. 43, Jalan PJS 11/22,  
Bandar Sunway  
46150 Petaling Jaya  
Selangor Darul Ehsan  
Telephone number +60 3 5633 7363  
Fax number +60 3 5633 6562  
[paul@cpotech.com.my](mailto:paul@cpotech.com.my)  
[www.cpotech.com.my](http://www.cpotech.com.my)
- MZ Mozambique**  
Please contact Phambili Interface South Africa
- NA Namibia**  
Please contact Phambili Interface South Africa
- NG Nigeria**  
Please contact Weidmüller Interface GmbH & Co. KG South Africa
- NL Netherlands**  
Weidmüller Benelux B. V.  
Franciscusweg 221  
1216 SE Hilversum  
P.O. Box 1505  
1200 BM Hilversum  
Telephone number +31 35 623 20 44  
[info@weidmuller.nl](mailto:info@weidmuller.nl)  
[www.weidmuller.nl](http://www.weidmuller.nl)
- NO Norway**  
Sivilingeniør J.F. Knudtzen AS  
Billingstadsletta 97  
1396 Billingstad  
PO Box 160  
1378 Nesbru  
Telephone number +47 66 98 33 50  
Fax number +47 66 98 09 55  
[firmapost@jfkknudtzen.no](mailto:firmapost@jfkknudtzen.no)  
[www.jfkknudtzen.no](http://www.jfkknudtzen.no)
- NZ New Zealand**  
Cuthbert S. Steward Ltd.  
27 Te Puni Street  
Petone  
PO Box 38496  
Wellington Mail Centre 5054  
Telephone number (04) 568 6156  
Fax number (09) 489 1752  
[csl@cuthbertsteward.co.nz](mailto:csl@cuthbertsteward.co.nz)  
Cuthbert S. Steward Ltd  
4 Fred Thomas Drive  
Aon Building, Ground Floor,  
South Entry  
Takapuna  
PO Box 100 338  
North Shore City 745  
Telephone number (09) 489 1751  
Fax number (04) 568 6056  
[cslak@cuthbertsteward.co.nz](mailto:cslak@cuthbertsteward.co.nz)
- OM Oman**  
DAN INTERNATIONAL LLC.  
Ghala St. 111  
BP 2901  
Seeb  
Telephone number +968 5036 77  
Fax number +968 5037 55  
[yedu@danintl.com](mailto:yedu@danintl.com)
- PE Peru**  
IMPEXINCA S.A.C.  
Calle Ortiz de Zevallos No.  
105, Urb. San Antonio  
18  
Lima, Miraflores  
Telephone number +51 1 447 5608  
[info@impexinca.pe](mailto:info@impexinca.pe)  
[www.impexinca.pe](http://www.impexinca.pe)  
J & W CIA, S. A.  
Calle 6 Mz. D Lte. 23, Urb.  
Ind. Grimanesa  
01  
Callao  
Telephone number +51 1 572 2539  
Fax number +51 1 572 0152  
[contacto@jwcia.com](mailto:contacto@jwcia.com)  
[www.jwcia.com](http://www.jwcia.com)
- PH Philippines**  
Enclosure Systems Specialists Inc.  
2276 Don Chino Roces  
Avenue Extension  
Room 103/105 Narra Building  
1231 Makati City  
Telephone number +63 2 813 8580  
Fax number +63 2 813 8596  
[sales\\_encsys@pldtdsl.net](mailto:sales_encsys@pldtdsl.net)  
[www.enclosuresystemsph.com](http://www.enclosuresystemsph.com)
- PK Pakistan**  
Automation Controls (Pak)  
Apartment No. 33 C III,  
Chenab Block, Allama Iqbal  
Town  
Lahore  
Telephone number +92 42 37809948  
Fax number +92 42 37809950  
[nadeem@acpak.com.pk](mailto:nadeem@acpak.com.pk)  
[www.acpak.com.pk](http://www.acpak.com.pk)
- PL Poland**  
Weidmüller Sp. z. o. o.  
ul. Ogrodowa 58  
00-876 Warszawa  
Telephone number +48 22 510 09 40  
Fax number +48 22 510 09 41  
[biuro@weidmuller.com.pl](mailto:biuro@weidmuller.com.pl)  
[www.weidmuller.pl](http://www.weidmuller.pl)
- PR Puerto Rico**  
Please contact W Interconnections Inc. United States
- PT Portugal**  
Weidmüller Sistemas de Interface S. A.  
Estrada Outeiro Polima, R.  
Augusto Dias da Silva, Lote B - Esc. 2  
São Domingos de Rana  
2785-515 Abóboda  
Telephone number +351 214 459 191  
Fax number +351 214 455 871  
[weidmuller@weidmuller.pt](mailto:weidmuller@weidmuller.pt)  
[www.weidmuller.pt](http://www.weidmuller.pt)
- PY Paraguay**  
Please contact CPI SA Argentina
- QA Qatar**  
Doha Motors  
PO Box 145  
Telephone number +974 4651441  
Fax number +974 4654579  
[dmtctech@qatar.net.qa](mailto:dmtctech@qatar.net.qa)  
<http://www.dohamotorsgroup.com/td.html>  
Petroleum Technology Co. W.L.L.  
PO Box 16069  
5th Floor Toyota tower  
Telephone number +974 44419603  
Fax number +974 44419604  
[petrotec@qatar.net.qa](mailto:petrotec@qatar.net.qa)  
[www.petrotec.com.qa](http://www.petrotec.com.qa)
- RO Romania**  
Representative Office Weidmüller Interface GmbH & Co. KG  
Ionescu Crum Street, No. 1, 1st Tower, 1st Floor,  
Office 4  
500446 Brasov - Brasov  
Business Park  
Telephone number +40 (268) 446 222  
Fax number +40 (268) 446 224  
[claudiu.totea@weidmuller.com](mailto:claudiu.totea@weidmuller.com)  
[www.weidmuller.ro](http://www.weidmuller.ro)
- RS Serbia**  
Representative Office Weidmüller Interface GmbH & Co. KG  
Ustanicka 189, III sprat lokal 7a  
11050 Beograd  
Telephone number +381 112885274  
Fax number +381 112885274  
[zoran.brabenovic@weidmuller.com](mailto:zoran.brabenovic@weidmuller.com)  
Tela Elektrik d.o.o.  
UI,Dr Drage Ljocić 6  
Beograd  
Telephone number +381 11 2772 415  
Fax number +381 11 2772 850  
[office@tela.rs](mailto:office@tela.rs)  
[www.tela.rs](http://www.tela.rs)
- RU Russia**  
Weidmüller Group  
7/10 Khlebozavodskiy  
Passage,  
Moskau  
115230  
Telephone number +7 495 280 72 71  
Fax number +7 495 280 72 71  
[Info@weidmuller.ru](mailto:Info@weidmuller.ru)  
[www.weidmuller.ru](http://www.weidmuller.ru)
- SA Saudi Arabia**  
Al Abdulkarim Holding Co.  
P.O. Box 4  
Dammam 31411  
Telephone number +966 3 8337110  
Fax number +966 3 8829547  
E-mail [salehsk@akh.com.sa](mailto:salehsk@akh.com.sa)  
[www.weidmuller.ae](http://www.weidmuller.ae)  
Saudi Electric Supply Company (SESCO)  
P.O. Box 32 98  
Al Khobar 31952  
Telephone number +966 3 6829546 Ext. 3030  
Fax number  
E-mail [Safdar.Malik@sescogex.com](mailto:Safdar.Malik@sescogex.com)  
[www.sescogex.com](http://www.sescogex.com)
- SE Sweden**  
Weidmüller AB  
Axel Danielssons väg 271  
BOX 31025  
SE-200 49 Malmö  
Telephone number +46 77-143 00 44  
Fax number +46 40-37 48 60  
[info@weidmuller.se](mailto:info@weidmuller.se)  
[www.weidmuller.se](http://www.weidmuller.se)
- SG Singapore**  
Weidmüller Pte. Ltd.  
70 Bendemeer Road  
# 04-03 Luzerne Building  
Singapore 339940  
Telephone number +65 6841 5311  
Fax number +65 6841 5377  
[info@weidmuller.com.sg](mailto:info@weidmuller.com.sg)  
[www.weidmuller.com.sg](http://www.weidmuller.com.sg)
- SI Slovenia**  
Elektrospoji d. o. o.  
Stegne 27  
SI- 1000 Ljubljana  
Osrednjeslovenska  
Telephone number +386 1 511 3810  
Fax number +386 1 511 1604  
[info@elektrospoji.si](mailto:info@elektrospoji.si)  
[www.elektrospoji.si](http://www.elektrospoji.si)

# Addresses worldwide

Let's connect.

**SK Slovakia**  
ELEKTRIS s.r.o.  
Elektrárenská 1  
831 04 Bratislava  
Telephone number +421  
2/4920 0113  
Fax number +421 2/4920  
0119  
bratislava@elektris.sk

**SV El Salvador**  
Prestegard Electro  
11 Avenida Norte No. 240  
Edificio Salazar No. 2  
San Salvador  
Telephone number +503  
2271 1690  
Fax number +503 2221  
3851  
prestegard@navegante.com.sv

**SY Syria**  
Please contact  
Weidmüller Middle East FZE  
United Arab Emirates

**SZ Swaziland**  
Please contact  
Phambili Interface  
South Africa

**TH Thailand**  
Pisanu Engineering Co. Ltd.  
Kwang Dingaeng, Khet  
Dingaeng  
800/2 Soi Trakulsuk, Asoke-  
dindaeng Road  
Dindaeng, Bangkok  
10400  
Telephone number +66 2  
248 2896  
Fax number +662 105 6301  
ecsales@pisanu.co.th  
www.pisanu.co.th

Representative Office  
Weidmüller Pte. Ltd.  
37/F, Sathorn Square Building  
98 North Sathorn Road  
Bangkok, Silom Bangrak  
10500  
Telephone number +66 2  
105 6300  
Fax number +66 2 642 9220  
info@weidmuller.com.sg

**TJ Tajikistan**  
Please contact  
our Representative Office  
Weidmüller Interface  
Azerbaijan.

**TM Turkmenistan**  
Please contact  
our Representative Office  
Weidmüller Interface  
Azerbaijan.

**TN Tunisia**  
Please contact  
Weidmüller E. U. R. L.  
France

**TR Turkey**  
Weidmüller Elektronik Ticaret  
Ltd. Sirketi  
Kavacik Mah. Orhan Veli Kanik  
Caddesi 9/1  
34810 Beykoz / Istanbul  
Telephone number +90 (216)  
537 10 70  
Fax number +90 (216) 537  
10 77  
info@weidmuller.com.tr  
www.weidmuller.com.tr

**TW Taiwan**  
Please contact  
Weidmüller (Hong Kong)  
Limited Co. Ltd.  
Hong Kong

**TZ Tanzania**  
Please contact  
our Representative Office  
Weidmüller Interface GmbH  
& Co. KG  
South Africa.

**UA Ukraine**  
LLC WM UKRAINE  
Levanevskogo str. 6  
Kiev  
3058  
Telephone number +38 044  
490 32 48  
Fax number  
info@wm-ua.com.ua  
wm-ua.com.ua/

Representative Office  
Weidmüller Interface GmbH  
& Co. KG  
Z. office 303  
7-D, Zdolbunivska str.  
Kiev, 2081  
Telephone number  
(mobile) +38 050 440 25 24  
info.ua@weidmueller.com

**US United States**  
W Interconnections Inc.  
821 Southlake Boulevard  
Richmond Virginia 23236  
Telephone number +1 (804)  
794-2877  
Fax number +1 (804) 379-  
2593  
info@weidmuller.com  
www.weidmuller.com

**UY Uruguay**  
REWU Uruguay S. A.  
AV. Bolivia 2001Esq  
Rocafuerte  
11300 Carrasco Montevideo  
Telephone number +598  
2604 8439  
Fax number +598 2604  
8439  
rewo@rewoouruguay.com.uy

**UZ Republic of Uzbekistan**  
Please contact  
our Representative Office  
Weidmüller Interface  
Azerbaijan.

**VE Venezuela**  
Somerinca C. A.  
Corazon de Jesus - 3ra  
Transversal con calle el  
Carmen- Los Dos Caminos  
Caracas 1070-A  
Telephone number +58  
2122352748  
Fax number +58  
2122399341  
klocmoeller@cantv.net  
www.somerinca.com

**VN Vietnam**  
AUMI Industrial Equipment &  
Automation Company Limited  
E1, La Thanh Hotel  
218 Doi Can Street  
Lieu Giai Ward, Ba Dinh  
District  
Hanoi City  
Telephone number +84 4  
37628601  
Fax number +84 4  
62661391  
aumi@aumi.com.vn  
www.aumi.com.vn

Representative Office  
Weidmüller Pte. Ltd.  
Level 16 Saigon Tower  
Building  
29 Le Duan Street  
District 1  
Ho Chi Minh  
Telephone number +848  
3520 7717  
Fax number +848 3520  
7604  
info@weidmuller.com.sg

**ZA South Africa**  
Phambili Interface  
PO Box 193  
1609 Johannesburg, Edenvale  
5 Bundo Road, Sebenza  
1610 Johannesburg  
Telephone number +27 (11)  
4521930  
Fax number  
info@weidmuller.co.za  
www.weidmuller.co.za

Representative Office  
Weidmüller Interface GmbH  
& Co. KG  
210 Amarand  
Avenue, Pegasus Building  
181 Pretoria, waterkloof Glen  
ext 2 -  
Telephone number +27 12  
003 2906  
Fax number +27 (11)  
4526455  
Jacques.Vosloo@weidmueller.  
com  
www.weidmueller.com

**ZM Zambia**  
Please contact  
Phambili Interface  
South Africa

**ZW Zimbabwe**  
Please contact  
Phambili Interface  
South Africa