

SL 5.08HC/07/90F 3.2SN OR BX

Weidmüller Interfaces GmbH & Co. KG

Postfach 3030

32760 Detmold

Tel. +49 5231 14-0

Fax. +49 5231 14-2083

info@weidmueller.com

www.weidmueller.com

Product image

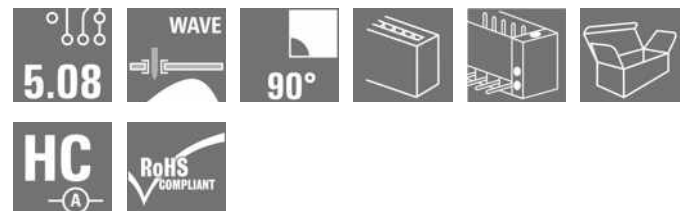

Pin headers made from glass-fibre-reinforced plastic with 90° wire outlet; optimised for wave soldering. The flange variant (F) can be screwed onto the respective counter piece or the circuit board. There is no need for an extra screw to connect the circuit board when the solder flange (LF) version is used. This also protects the solder points from mechanical strain. All pin headers can be manually coded or ordered pre-coded. HC = High Current.

General ordering data

Version	PCB plug-in connector, male header, Flange, THT solder connection, 5.08 mm, Number of poles: 7, 90°, Solder pin length (l): 3.2 mm, tinned, orange, Box
Order No.	1148780000
Type	SL 5.08HC/07/90F 3.2SN OR BX
GTIN (EAN)	4032248935727
Qty.	36 pc(s).
Product data	IEC: 400 V / 24 A UL: 300 V / 18.5 A
Packaging	Box

SL 5.08HC/07/90F 3.2SN OR BX

Weidmüller Interfaces GmbH & Co. KG

Postfach 3030

32760 Detmold

Tel. +49 5231 14-0

Fax. +49 5231 14-2083

info@weidmueller.com

www.weidmueller.com

Technical data

Dimensions and weights

Depth	12 mm	Depth (inches)	0.472 inch
Height	11.7 mm	Height (inches)	0.461 inch
Height of lowest version	8.5 mm	Width	45.72 mm
Width (inches)	1.8 inch	Net weight	3.396 g

Temperatures

Operating temperature, min.	-50 °C	Operating temperature, max.	100 °C
-----------------------------	--------	-----------------------------	--------

System specifications

Product family	OMNIMATE Signal - series BL/SL 5.08		
Type of connection	Board connection		
Mounting onto the PCB	THT solder connection		
Pitch in mm (P)	5.08 mm		
Pitch in inches (P)	0.2 inch		
Outgoing elbow	90°		
Number of poles	7		
Number of solder pins per pole	1		
Solder pin length (l)	3.2 mm		
Solder pin length tolerance	+0.1 / -0.3 mm		
Solder pin dimensions	d = 1.2 mm, Octagonal		
Solder pin dimensions = d tolerance	0 / -0.03 mm		
Solder eyelet hole diameter (D)	1.3 mm		
Solder eyelet hole diameter tolerance (D)	+ 0,1 mm		
L1 in mm	30.48 mm		
L1 in inches	1.2 inch		
Number of rows	1		
Pin series quantity	1		
Touch-safe protection acc. to DIN VDE 57 106	finger-safe unplugged/ back-of-hand-safe plugged		
Touch-safe protection acc. to DIN VDE 0470	IP20 plugged/ IP10 unplugged		
Protection degree	IP20		
Volume resistance	≤5 mΩ		
Can be coded	Yes		
Plugging cycles	25		
Plugging force/pole, max.	10 N		
Pulling force/pole, max.	7.5 N		
Tightening torque	Torque type	Mounting screw, PCB	
	Usage information	Tightening torque	min. 0.15 Nm max. 0.2 Nm
		Recommended screw	Part number PTSC KA 2.2X4.5 WN1412

SL 5.08HC/07/90F 3.2SN OR BX

Weidmüller Interfaces GmbH & Co. KG

Postfach 3030

32760 Detmold

Tel. +49 5231 14-0

Fax. +49 5231 14-2083

info@weidmueller.com

www.weidmueller.com

Technical data

Material data

Insulating material	PA GF	Colour	RAL 2000
Colour chart (similar)	RAL 2000	Insulating material group	II
Comparative Tracking Index (CTI)	≥ 550	UL 94 flammability rating	V-0
Contact material	CuMg	Contact surface	tinned
Layer structure of solder connection	1...3 µm Ni / 2...4 µm Sn matt	Layer structure of plug contact	1...3 µm Ni / 2...4 µm Sn matt
Storage temperature, min.	-40 °C	Storage temperature, max.	70 °C
Operating temperature, min.	-50 °C	Operating temperature, max.	100 °C
Temperature range, installation, min.	-25 °C	Temperature range, installation, max.	100 °C

Rated data acc. to IEC

tested acc. to standard	IEC 60664-1, IEC 61984	Rated current, min. number of poles (Tu=20°C)	24 A
Rated current, max. number of poles (Tu=20°C)	19 A	Rated current, min. number of poles (Tu=40°C)	21 A
Rated current, max. number of poles (Tu=40°C)	16.5 A	Rated voltage for surge voltage class / pollution degree II/2	400 V
Rated voltage for surge voltage class / pollution degree III/2	320 V	Rated voltage for surge voltage class / pollution degree III/3	250 V
Rated impulse voltage for surge voltage class/ pollution degree II/2	4,000 V	Rated impulse voltage for surge voltage class/ pollution degree III/2	4 kV
Rated impulse voltage for surge voltage class/ contamination degree III/3	4 kV		

Rated data acc. to CSA

Rated voltage (Use group B / CSA)	300 V	Rated voltage (Use group D / CSA)	300 V
Rated current (Use group B / CSA)	18.5 A	Rated current (Use group D / CSA)	10 A

Rated data acc. to UL 1059

Institute (cURus)		Certificate No. (cURus)	E60693
Rated voltage (Use group B / UL 1059)	300 V	Rated voltage (Use group D / UL 1059)	300 V
Rated current (Use group B / UL 1059)	18.5 A	Rated current (Use group D / UL 1059)	10 A
Reference to approval values	Specifications are maximum values, details - see approval certificate.		

Packing

Packaging	Box	VPE length	340 mm
VPE width	134 mm	VPE height	23 mm

Classifications

ETIM 6.0	EC002637	ETIM 7.0	EC002637
ETIM 8.0	EC002637	ECLASS 9.0	27-44-04-02
ECLASS 9.1	27-44-04-02	ECLASS 10.0	27-44-04-02
ECLASS 11.0	27-46-02-01	ECLASS 12.0	27-46-02-01

Creation date April 25, 2023 3:37:14 PM CEST

Catalogue status 14.04.2023 / We reserve the right to make technical changes.

SL 5.08HC/07/90F 3.2SN OR BX

Weidmüller Interfaces GmbH & Co. KG

Postfach 3030

32760 Detmold

Tel. +49 5231 14-0

Fax. +49 5231 14-2083

info@weidmueller.com

www.weidmueller.com

Technical data**Important note**

IPC conformity	Conformity: The products are developed, manufactured and delivered according to international recognized standards and norms and comply with the assured properties in the data sheet resp. fulfill decorative properties in accordance with IPC-A-610 "Class 2". Further claims on the products can be evaluated on request.
Notes	<ul style="list-style-type: none"> • Additional variants on request • Gold-plated contact surfaces on request • Rated current related to rated cross-section & min. No. of poles. • P on drawing = pitch • Rated data refer only to the component itself. Clearance and creepage distances to other components are to be designed in accordance with the relevant application standards. • Long term storage of the product with average temperature of 50 °C and average humidity 70%, 36 months

Approvals

Approvals



ROHS	Conform
UL File Number Search	UL Website
Certificate No. (cURus)	E60693

Downloads

Approval/Certificate/Document of Conformity	Declaration of the Manufacturer
Engineering Data	CAD data – STEP
Catalogues	Catalogues in PDF-format
Brochures	FL DRIVES EN MB DEVICE MANUF. EN FL DRIVES DE FL BUILDING SAFETY EN FL APPL LED LIGHTING EN FLIndustr.CONTROLS EN FL MACHINE SAFETY EN FL HEATING ELECTR EN FL APPL INVERTER EN FL_BASE_STATION_EN FL ELEVATOR EN FL POWER SUPPLY EN FL 72H SAMPLE SER EN PO OMNIMATE EN PO OMNIMATE EN

SL 5.08HC/07/90F 3.2SN OR BX

Weidmüller Interfaces GmbH & Co. KG

Postfach 3030

32760 Detmold

Tel. +49 5231 14-0

Fax. +49 5231 14-2083

Drawings

Product image



Dimensional drawing info@weidmueller.com

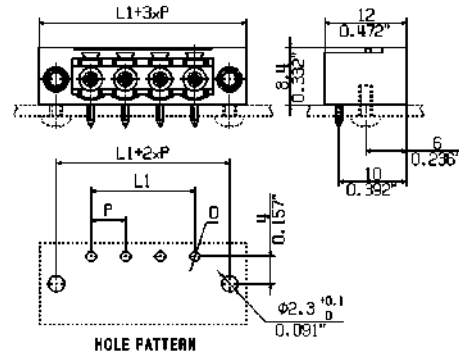

Graph

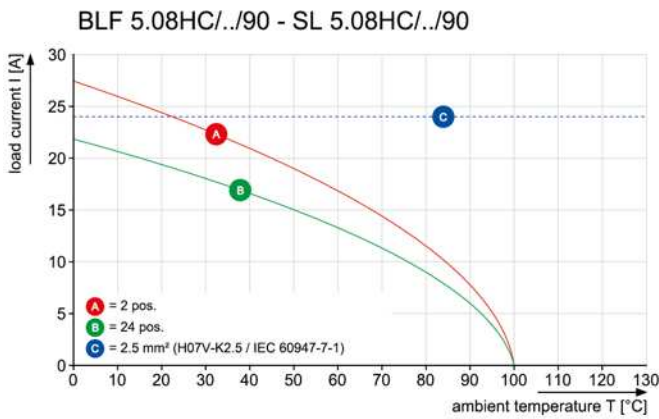

Graph

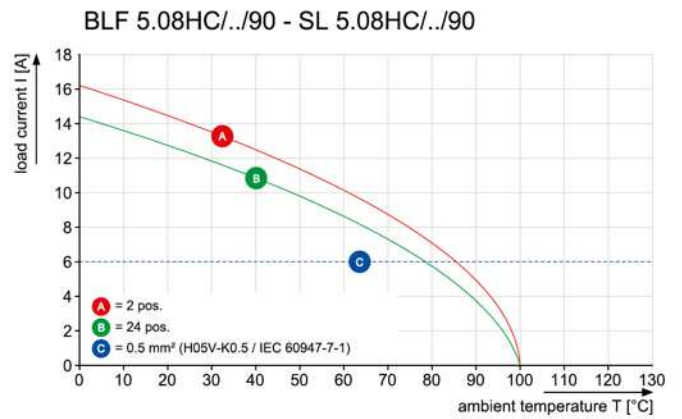

Graph

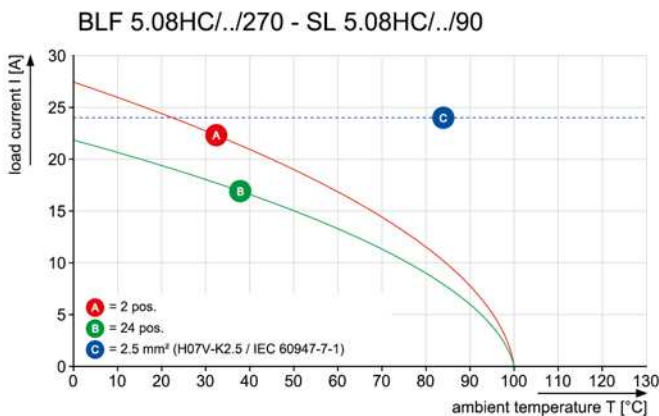

Graph

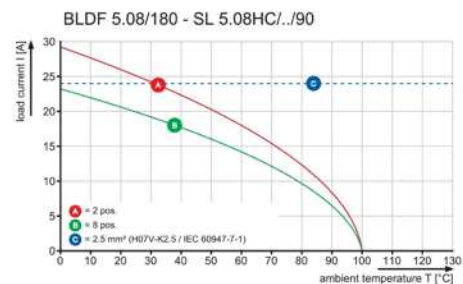

Data sheet**SL 5.08HC/07/90F 3.2SN OR BX****Weidmüller Interfaces GmbH & Co. KG**

Postfach 3030

32760 Detmold

Tel. +49 5231 14-0

Fax. +49 5231 14-2083

info@weidmueller.com

www.weidmueller.com

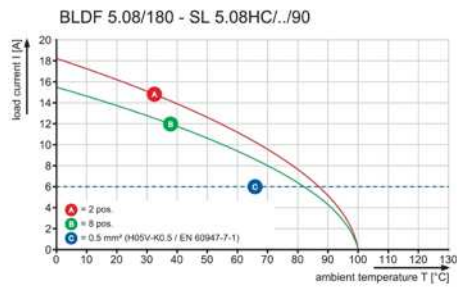
Drawings**Graph**

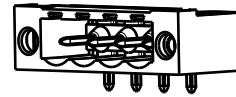
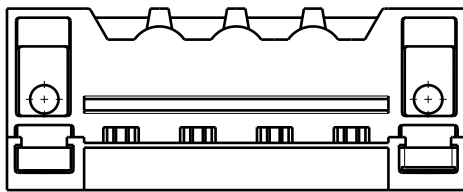
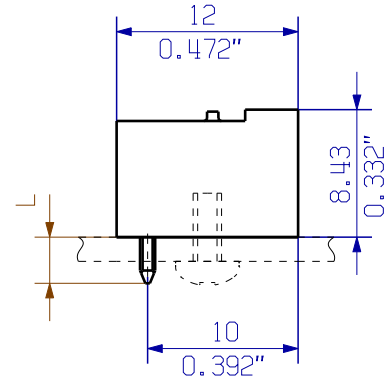
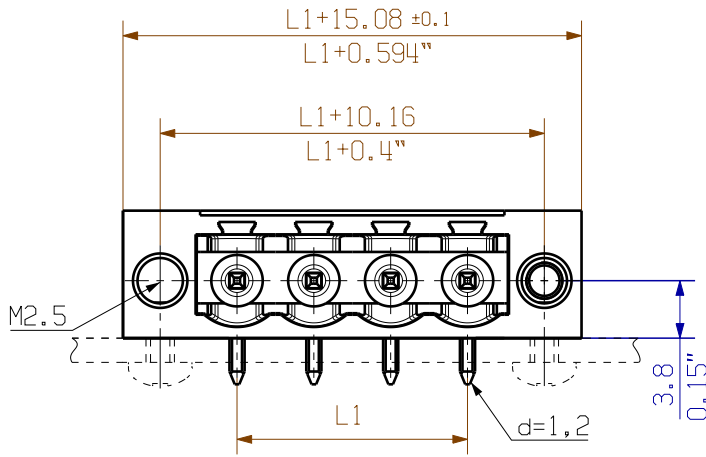

1/1

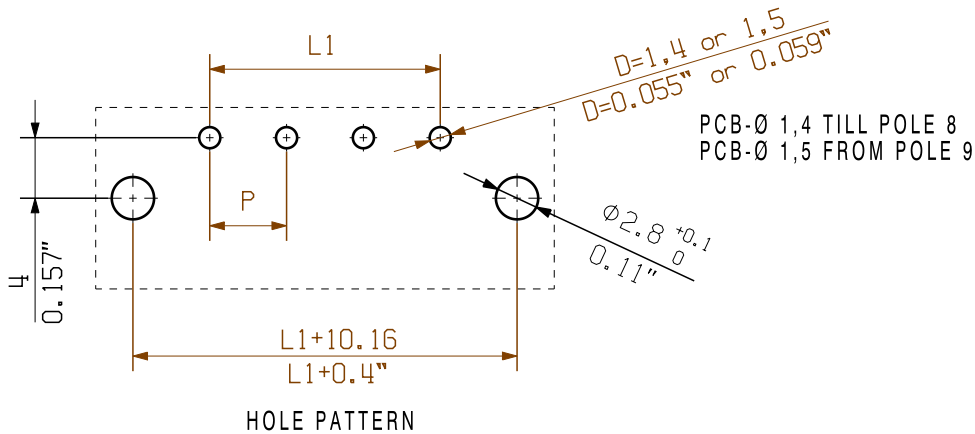

HOLE PATTERN

For the mounting of PCBs, it should be noted that the rated data relates only to the PCB components alone.
 The necessary creepage and clearance paths must be observed in connection with the respective applicant in accordance to IEC 664 / VDE 0110.
 The current-carrying capacity and pitch tolerance is to be determined according to DIN IEC 326 part 3 very fine.

Weidmüller PCB components are tested to the DIN EN 61984 standard, and are valid for its field of application. Provided that the components are used to the intended purpose, all requirements with respect to the occurring of electrical, mechanical, thermic and corrosive stress will be satisfied.

P = PITCH

SHOWN: SL 5.08HC/04/90F

24	116,84	4,600
23	111,76	4,400
22	106,68	4,200
21	101,60	4,000
20	96,52	3,800
19	91,44	3,600
18	86,36	3,400
17	81,28	3,200
16	76,20	3,000
15	71,12	2,800
14	66,04	2,600
13	60,96	2,400
12	55,88	2,200
11	50,80	2,000
10	45,72	1,800
9	40,64	1,600
8	35,56	1,400
7	30,48	1,200
6	25,40	1,000
5	20,32	0,800
4	15,24	0,600
3	10,16	0,400
2	5,08	0,200
n	L1 [mm]	L1 [inch]

STIFTLAENGE L PIN LENGTH L	TOLERANZ TOLERANCE
3,2	0,1
	-0,3
4,5	0,1
	-0,3

	DIN ISO 2768-m	101482/5 07.02.18 HELIS_MA 00			Cat.no.: 3 48753 04
	Modification		Drawing no. Issue no.		
	Date	Name	SL 5.08HC/.. /90... STIFTLISTE MALE HEADER		
	Drawn	18.10.2010			
Responsible		HERTEL_S			
Scale: 2:1	Checked	27.02.2018	HELIS_MA	Sheet 04 of 05 sheets	7377
Supersedes: .	Approved		LANG_T	Product file: SL-HP 5.08	

The reproduction, distribution and utilization of this document as well as the communication of its contents without explicit authorization is prohibited. Offenders will be held liable for the payment of damages. Weidmüller exclusively reserves the right to file for patents, utility models or designs.

© Weidmüller Interface GmbH & Co. KG

Recommended wave soldering profiles

Weidmüller Interface GmbH & Co. KG
 Klingenbergstraße 16
 D-32758 Detmold
 Germany
 Fon: +49 5231 14-0
 Fax: +49 5231 14-292083
 www.weidmueller.com

Single Wave:



Double Wave:

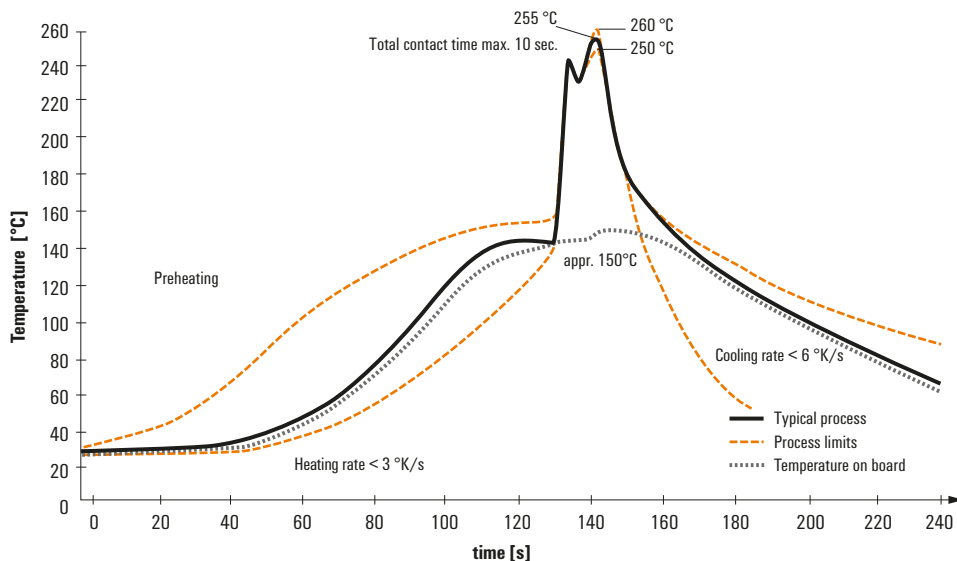

Wave soldering profiles

Wired connection elements should be processed in accordance with the DIN EN 61760-1 standard. We have included two recommendations for practical wave soldering profiles, with which Weidmüller PCB terminals and connectors are qualified.

When choosing a suitable profile for your application, the following factors also need to be considered:

- PCB thickness
- Proportion of Cu in the layers
- Single/double-sided assembly
- Product range
- Heating and cooling rates

The single and double wave profiles each indicate the recommended operating range, including the maximum soldering temperature of 260°C. In practice, the maximum soldering temperature is quite often well below the above maximum profile.