

## TOP1.5GS12/90 7 2STI OR

**Weidmüller Interface GmbH & Co. KG**

Klingenbergstraße 26

D-32758 Detmold

Germany

www.weidmueller.com

### Product image

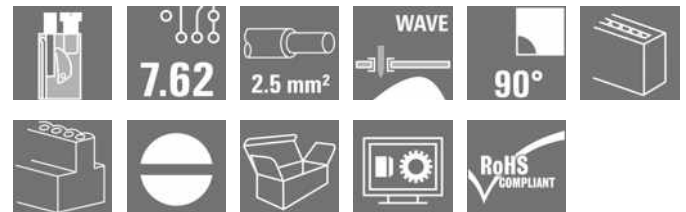

Similar to illustration

Conductor entry and screw connection in the same direction on this PCB terminal with 7.62 mm pitch for conductor cross-sections up to 2.5 mm<sup>2</sup>. Conductor outlet direction 90° and 180°.

### General ordering data

Version	Printed circuit board terminals, 7.62 mm, Number of poles: 12, 90°, Solder pin length (l): 3.5 mm, tinned, orange, TOP connection, Clamping range, max.: 2.5 mm <sup>2</sup> , Box
Order No.	<a href="#">0394160000</a>
Type	TOP1.5GS12/90 7 2STI OR
GTIN (EAN)	4032248203796
Qty.	20 pc(s).
Product data	IEC: 1000 V / 24 A / 0.5 - 2.5 mm <sup>2</sup> UL: 300 V / 10 A / AWG 26 - AWG 14
Packaging	Box
Creation date	January 20, 2023 9:06:55 AM CET
Available until	2023-03-31

This article will no longer be available in the future.

## TOP1.5GS12/90 7 2STI OR

**Weidmüller Interface GmbH & Co. KG**

Klingenbergstraße 26

D-32758 Detmold

Germany

www.weidmueller.com

## Technical data

### Dimensions and weights

Depth	19.5 mm	Depth (inches)	0.768 inch
Height	22 mm	Height (inches)	0.866 inch
Height of lowest version	18.5 mm	Width	93.24 mm
Width (inches)	3.671 inch	Net weight	48.35 g

### Temperatures

Operating temperature, min.	-50 °C	Operating temperature, max.	100 °C
-----------------------------	--------	-----------------------------	--------

### System parameters

Product family	OMNIMATE Signal - series TOP1.5GS	Wire connection method	TOP connection
Mounting onto the PCB	THT solder connection	Conductor outlet direction	90°
Pitch in mm (P)	7.62 mm	Pitch in inches (P)	0.3 inch
Number of poles	12	Pin series quantity	1
Fitted by customer	No	Number of rows	1
Solder pin length (l)	3.5 mm	Solder pin dimensions	0.8 x 1.0 mm
Solder eyelet hole diameter (D)	1.3 mm	Solder eyelet hole diameter tolerance (D)+	0,1 mm
Number of solder pins per pole	2	Screwdriver blade	0.6 x 3.5
Screwdriver blade standard	DIN 5264	Tightening torque, min.	0.4 Nm
Tightening torque, max.	0.5 Nm	Clamping screw	M 2.5
Stripping length	10 mm	L1 in mm	83.82 mm
L1 in inches	3.3 inch	Touch-safe protection acc. to DIN VDE 0470	IP 20
Touch-safe protection acc. to DIN VDE 57 106	Safe from finger touch	Protection degree	IP20
Volume resistance	1.20 mΩ		

### Material data

Insulating material	PA	Colour	orange
Colour chart (similar)	RAL 2000	Insulating material group	I
Comparative Tracking Index (CTI)	≥ 600	Insulation strength	≥ 10 <sup>8</sup> Ω
UL 94 flammability rating	V-2	Contact material	CuZn
Contact surface	tinned	Layer structure of solder connection	1.5...3 μm Ni / 4...6 μm Sn
Storage temperature, min.	-40 °C	Storage temperature, max.	70 °C
Operating temperature, min.	-50 °C	Operating temperature, max.	100 °C
Temperature range, installation, min.	-25 °C	Temperature range, installation, max.	100 °C

### Conductors suitable for connection

Clamping range, min.	0.13 mm <sup>2</sup>
Clamping range, max.	2.5 mm <sup>2</sup>
Wire connection cross section AWG, min.	AWG 26
Wire connection cross section AWG, max.	AWG 14
Solid, min. H05(07) V-U	0.5 mm <sup>2</sup>
Solid, max. H05(07) V-U	2.5 mm <sup>2</sup>
Flexible, min. H05(07) V-K	0.5 mm <sup>2</sup>
Flexible, max. H05(07) V-K	2.5 mm <sup>2</sup>
w. plastic collar ferrule, DIN 46228 pt 4, 0.5 mm <sup>2</sup> min.	
w. plastic collar ferrule, DIN 46228 pt 4, 2.5 mm <sup>2</sup> max.	

Creation date January 20, 2023 9:05:53 AM CET

**TOP1.5GS12/90 7 2STI OR**

**Weidmüller Interface GmbH & Co. KG**  
 Klingenbergstraße 26  
 D-32758 Detmold  
 Germany

www.weidmueller.com

**Technical data**

w. wire end ferrule, DIN 46228 pt 1, min.	0.5 mm <sup>2</sup>
w. wire end ferrule, DIN 46228 pt 1, max.	2.5 mm <sup>2</sup>
Plug gauge in accordance with EN 60999 a x b; ø	2.4 mm x 1.5 mm

Clampable conductor	Cross-section for conductor connection	Type	fine-wired
		nominal	0.5 mm <sup>2</sup>
wire end ferrule		Stripping length	nominal 12 mm
		Recommended wire-end ferrule	<a href="#">H0.5/16 OR</a>
		Stripping length	nominal 10 mm
		Recommended wire-end ferrule	<a href="#">H0.5/10</a>
Cross-section for conductor connection		Type	fine-wired
		nominal	0.75 mm <sup>2</sup>
wire end ferrule		Stripping length	nominal 12 mm
		Recommended wire-end ferrule	<a href="#">H0.75/16 W</a>
		Stripping length	nominal 10 mm
		Recommended wire-end ferrule	<a href="#">H0.75/10</a>
Cross-section for conductor connection		Type	fine-wired
		nominal	1 mm <sup>2</sup>
wire end ferrule		Stripping length	nominal 12 mm
		Recommended wire-end ferrule	<a href="#">H1.0/16D R</a>
		Stripping length	nominal 10 mm
		Recommended wire-end ferrule	<a href="#">H1.0/10</a>
Cross-section for conductor connection		Type	fine-wired
		nominal	1.5 mm <sup>2</sup>
wire end ferrule		Stripping length	nominal 10 mm
		Recommended wire-end ferrule	<a href="#">H1.5/10</a>
		Stripping length	nominal 12 mm
		Recommended wire-end ferrule	<a href="#">H1.5/16 R</a>
Cross-section for conductor connection		Type	fine-wired
		nominal	2.5 mm <sup>2</sup>
wire end ferrule		Stripping length	nominal 10 mm
		Recommended wire-end ferrule	<a href="#">H2.5/10</a>

Reference text Length of ferrules is to be chosen depending on the product and the rated voltage., The outside diameter of the plastic collar should not be larger than the pitch (P)

**Rated data acc. to IEC**

tested acc. to standard		Rated current, min. number of poles (Tu=20°C)	
	IEC 60664-1, IEC 61984		24 A
Rated current, max. number of poles (Tu=20°C)	19 A	Rated current, min. number of poles (Tu=40°C)	21 A
Rated current, max. number of poles (Tu=40°C)	16 A	Rated voltage for surge voltage class / pollution degree II/2	1,000 V
Rated voltage for surge voltage class / pollution degree III/2	630 V	Rated voltage for surge voltage class / pollution degree III/3	400 V
Rated impulse voltage for surge voltage class/ pollution degree II/2	4 kV	Rated impulse voltage for surge voltage class/ pollution degree III/2	4 kV
Rated impulse voltage for surge voltage class/ contamination degree III/3	4 kV	Short-time withstand current resistance	3 x 1s with 120 A

Creation date January 20, 2023 9:05:53 AM CET

**TOP1.5GS12/90 7 2STI OR**
**Weidmüller Interface GmbH & Co. KG**

Klingenbergstraße 26

D-32758 Detmold

Germany

www.weidmueller.com

**Technical data**
**Rated data acc. to CSA**

Institute (CSA)



Certificate No. (CSA)

154685-1501716

Rated voltage (Use group B / CSA) 300 V

Rated voltage (Use group D / CSA) 300 V

Rated current (Use group B / CSA) 10 A

Rated current (Use group D / CSA) 10 A

Wire cross-section, AWG, min. AWG 26

Wire cross-section, AWG, max. AWG 14

Reference to approval values

Specifications are maximum values, details - see approval certificate.

**Rated data acc. to UL 1059**

Rated voltage (Use group B / UL 1059) 300 V

Rated voltage (Use group D / UL 1059) 300 V

Rated current (Use group B / UL 1059) 10 A

Rated current (Use group D / UL 1059) 10 A

Wire cross-section, AWG, min. AWG 26

Wire cross-section, AWG, max. AWG 14

**Packing**

Packaging	Box	VPE length	226 mm
VPE width	109 mm	VPE height	45 mm

**Classifications**

ETIM 6.0	EC002643	ETIM 7.0	EC002643
ETIM 8.0	EC002643	ECLASS 9.0	27-44-04-01
ECLASS 9.1	27-44-04-01	ECLASS 10.0	27-44-04-01
ECLASS 11.0	27-46-01-01	ECLASS 12.0	27-46-01-01

**Important note**

IPC conformity

Conformity: The products are developed, manufactured and delivered according international recognized standards and norms and comply with the assured properties in the data sheet resp. fulfill decorative properties in accordance with IPC-A-610 "Class 2". Further claims on the products can be evaluated on request.

Notes

- Additional variants on request
- Rated current related to rated cross-section & min. No. of poles.
- Wire end ferrule without plastic collar to DIN 46228/1
- Wire end ferrule with plastic collar to DIN 46228/4
- Crimp form A for wire end ferrules with PZ 6/5 crimping tool are recommended for the largest cable sizes.
- P on drawing = pitch
- Rated data refer only to the component itself. Clearance and creepage distances to other components are to be designed in accordance with the relevant application standards.
- Long term storage of the product with average temperature of 50 °C and average humidity 70%, 36 months

**TOP1.5GS12/90 7 2STI OR**

**Weidmüller Interface GmbH & Co. KG**  
Klingenbergstraße 26  
D-32758 Detmold  
Germany

[www.weidmueller.com](http://www.weidmueller.com)

**Technical data****Approvals**

Approvals



ROHS

Conform

**Downloads**

Engineering Data	<a href="#">CAD data – STEP</a>
Engineering Data	<a href="#">WSCAD</a>
Catalogues	<a href="#">Catalogues in PDF-format</a>
Brochures	<a href="#">FL DRIVES EN</a> <a href="#">FL ANALO.SIGN.CONV. EN</a> <a href="#">MB DEVICE MANUF. EN</a> <a href="#">FL DRIVES DE</a> <a href="#">FL BUILDING SAFETY EN</a> <a href="#">FL APPL LED LIGHTING EN</a> <a href="#">FLIndustr.CONTROLS EN</a> <a href="#">FL MACHINE SAFETY EN</a> <a href="#">FL HEATING ELECTR EN</a> <a href="#">FL APPL INVERTER EN</a> <a href="#">FL_BASE_STATION_EN</a> <a href="#">FL ELEVATOR EN</a> <a href="#">FL POWER SUPPLY EN</a> <a href="#">FL 72H SAMPLE SER EN</a> <a href="#">PO OMNIMATE EN</a> <a href="#">PO OMNIMATE EN</a>

**TOP1.5GS12/90 7 2STI OR**

**Weidmüller Interface GmbH & Co. KG**  
 Klingenbergstraße 26  
 D-32758 Detmold  
 Germany

www.weidmueller.com

**Drawings**

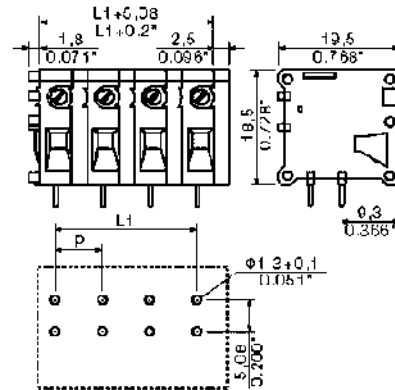

**Dimensional drawing**

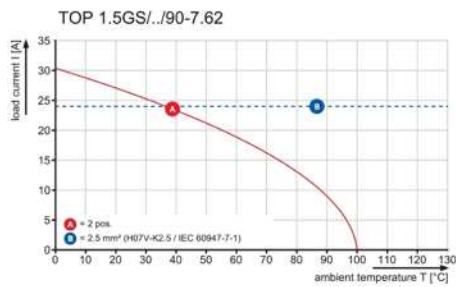

**Graph**



**Technical Data**

<b>Rev.</b>		
<b>Material data</b>		
Insulation material type		PA 66
Insulation material colours		S 33230
Insulation material flammability class	UL94	V-2
Insulation resistance	MOhm	10 <sup>3</sup>
Contact base material		CuZn
Contact plating (mating end)		Tin-plated
Contact plating (solder end)		n/a
<b>System characteristic values</b> together with counterpart		
Pitch P	mm/inch	7.62 / 0.3
Number of rows		1
Dielectric strength (r.m.s withstand voltage)	kV	2.5
Conductor connection methode		TOP connection
Plug in force (max.)	N/pole	n/a
Pull out force (max.)	N/pole	n/a
Through resistance (typical)	mOhm	0.9
Operating temperature range	°C	-20....+100
Degree of protection acc. to VDE 0106 (plugged/unplugged)		finger safe
Degree of protection acc. to DIN EN 60529 (plugged/unplugged)		IP20
Solder pin length L	mm/inch	3.5
PCB hole diameter D (wave soldering)	mm/inch	1.3
PCB hole diameter D (reflow soldering)	mm/inch	n/a
Resistance to soldering heat acc. to DIN IEC 60512-6	°C/sec	260/10
Resistance to soldering heat acc. to EN 61760-1	°C/sec	n/a
Solderability classification acc. to EN 61760-1		n/a
Solder connection type		wave soldering
Solder pin diameter d (max.)	mm/inch	1.28/0.05
<b>Application notes</b>		
Coding possibility	yes/no	no
Joinable without loss of pitch	yes/no	no
Manual assembly of modules	yes/no	yes
Max. number of poles	n	12
<b>IEC 664-1 / VDE0110 (4.97) rated data</b>		
Rated cross section acc. to EN 60999	mm <sup>2</sup>	1.5
Rated current @ 20°C ambient (together with)	A	16
Rated current @ 40°C ambient (together with)	A	xxx
<b>Overvoltage category / Pollution degree</b>		
Rated voltage	V	500 630 1000
Rated impulse voltage	kV	6.0 6.0 6.0
<b>UL 1059 rated data</b>  File No.: E60693		
Rated voltage	V	300
Rated current	A	10
Clamping range	mm <sup>2</sup> / AWG	0.5...1.5/26..14
<b>CSA C22.2 rated data</b>  File No.: LR12400		
Rated voltage	V	300
Rated current	A	10
Clamping range	mm <sup>2</sup> / AWG	0.5.....1.5/26....14
<b>Packaging</b>		
		carton
<b>Downloads</b>		
		www.weidmueller.de

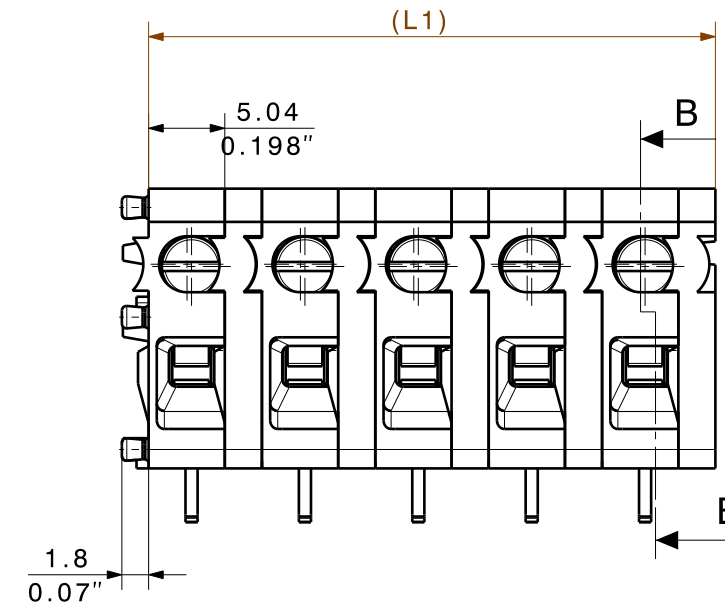
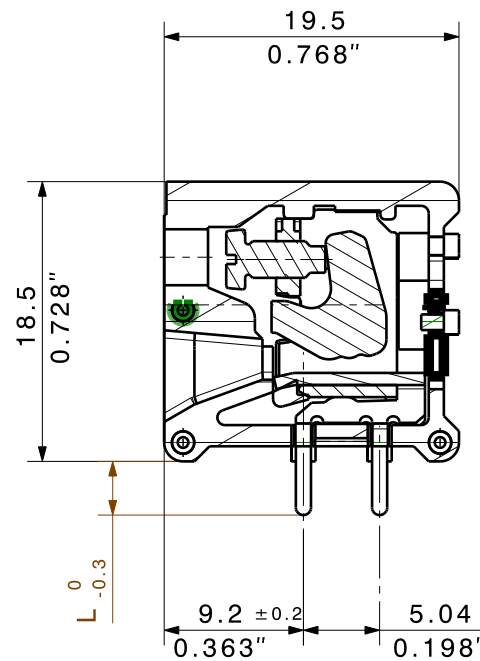

**Drilling Diagram**

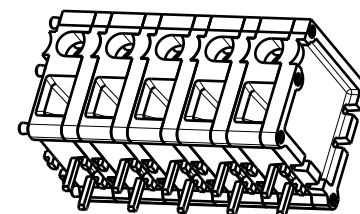
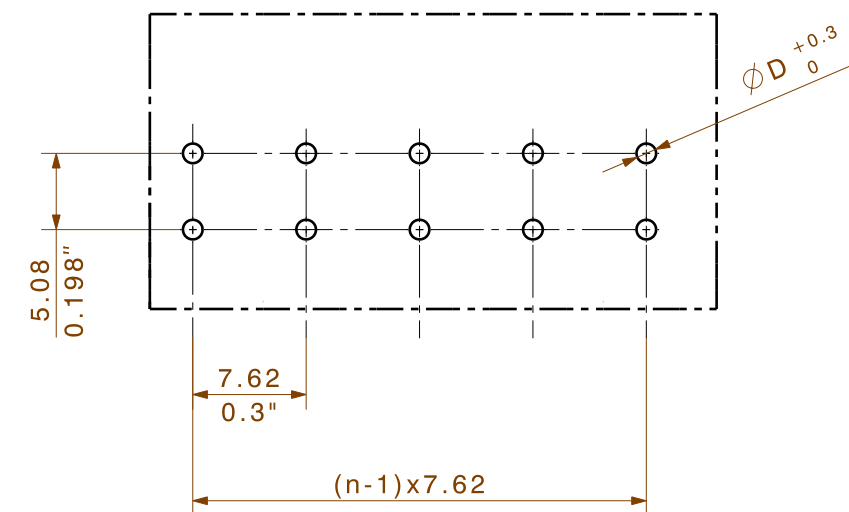

12	91,44	3,600
11	83,82	3,300
10	76,20	3,000
9	68,58	2,700
8	60,96	2,400
7	53,34	2,100
6	45,72	1,800
5	38,10	1,500
4	30,48	1,200
3	22,86	0,900
2	15,24	0,600
1	7,62	0,300
n	L1 [mm]	L1 [Inch]

02 Zeichnung komplett überarbeitet

- Without locking latches
- Sum of ambient temperature and temperature rise
- Recommendation for manual assembly
- Recommendation for automatic assembly
- Recommendation for wave soldering
- Recommendation for reflow soldering
- Referred to rated cross section and minimum pole number

n.a. = not applicable

Subject to technical changes

For the mounting of PCBs, it should be noted that the rated data stated here relates only to the PCB components alone. The necessary creepage and clearance paths must be observed in connection with the respective applicant in accordance to IEC 664 / VDE 0110. The current-carrying capacity and pitch tolerance is to be determined according to DIN IEC 326 part 3 very fine.

Weidmüller PCB components are tested to the DIN EN 61984 standard, and are valid for its field of application. Provided that the components are used to the intended purpose, all requirements with respect to the occurring of electrical, mechanical, thermic and corrosive stress will be satisfied.

METRIC TOLERANCES: X. = ±0.3 X.X = ±0.1 X.XX = ±0.05		35928/5 05.09.06 KRUG_M 01		CAT.NO.:	
MODIFICATION				C 33230 02	
METRIC/INCH DIMENSIONS		DATE	NAME	DRAWING NO. ISSUE NO.	
SCALE: 2:1		DRAWN	06.04.2004	HEINEL_M	
SUPERSEDES:		RESPONSIBLE		KRUG_M	
SUPERSEDED BY:.		CHECKED	05.09.2006	HECKERT_M	
		APPROVED		GUENTHER_W	PRODUCT FILE:
				SHEET 3	OF 4 SHEETS
				TOP 1.5 GS /90 2STI	

WEITERGABE SOWIE VERVIELFÄLTIGUNG DIESES DOKUMENTS, VERWERTUNG UND MITTEILUNG SEINES INHALTS SIND VERBOTEN, SOWEIT NICHT AUSDRUECKLICH GESTATET. ZUWIDERHANDLUNGEN VERPFLICHTEN ZU SCHADENSERSATZ. ALLE RECHTE FUER DEN FALL DER PATENT-, GEBRAUCHSMUSTER- ODER GESCHMACKSMUSTERINTEGRATION VORBEHALTEN. THE REPRODUCTION, DISTRIBUTION AND UTILIZATION OF THIS DOCUMENT AS WELL AS THE COMMUNICATION OF ITS CONTENTS TO OTHERS WITHOUT EXPLICIT AUTHORIZATION IS PROHIBITED. OFFENDERS WILL BE HELD LIABLE FOR THE PAYMENT OF DAMAGES. ALL RIGHTS RESERVED IN THE EVENT OF THE GRANT OF A PATENT, UTILITY MODEL OR DESIGN.

## Recommended wave soldering profiles

**Weidmüller Interface GmbH & Co. KG**  
 Klängenbergstraße 16  
 D-32758 Detmold  
 Germany  
 Fon: +49 5231 14-0  
 Fax: +49 5231 14-292083  
 www.weidmueller.com

### Single Wave:



### Double Wave:

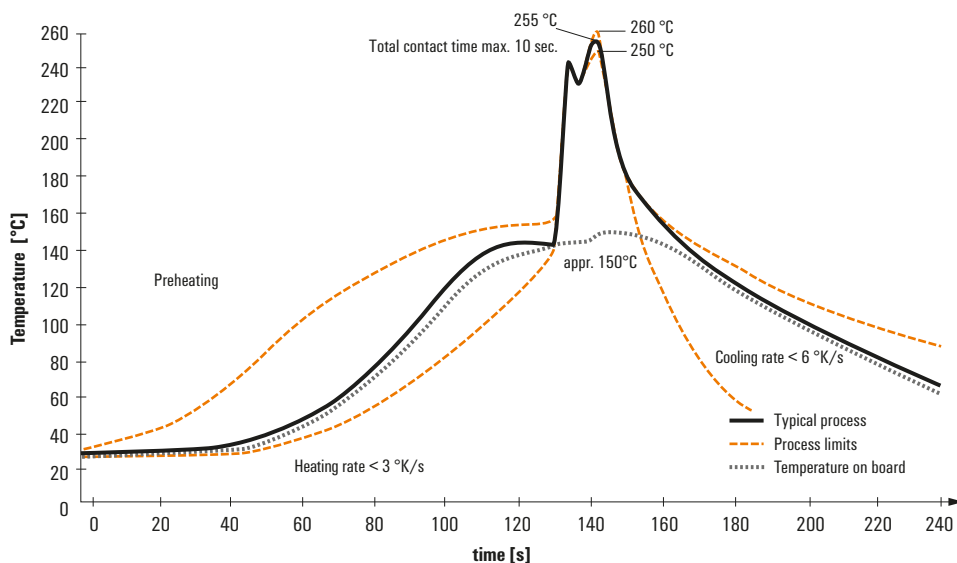

### Wave soldering profiles

Wired connection elements should be processed in accordance with the DIN EN 61760-1 standard. We have included two recommendations for practical wave soldering profiles, with which Weidmüller PCB terminals and connectors are qualified.

When choosing a suitable profile for your application, the following factors also need to be considered:

- PCB thickness
- Proportion of Cu in the layers
- Single/double-sided assembly
- Product range
- Heating and cooling rates

The single and double wave profiles each indicate the recommended operating range, including the maximum soldering temperature of 260°C. In practice, the maximum soldering temperature is quite often well below the above maximum profile.