

# Data sheet | Item number: 769-606/006-000

1-conductor male connector; Snap-in flange; 4 mm<sup>2</sup>; Pin spacing 5 mm; 6-pole

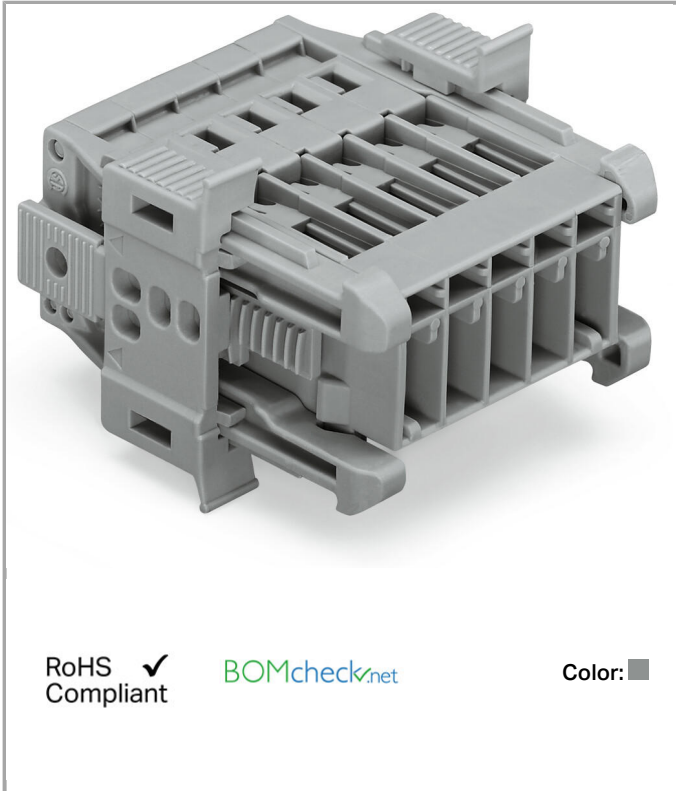

769-606/006-000



RoHS  Compliant

[BOMcheck.net](https://www.bomcheck.net)

Color: ■

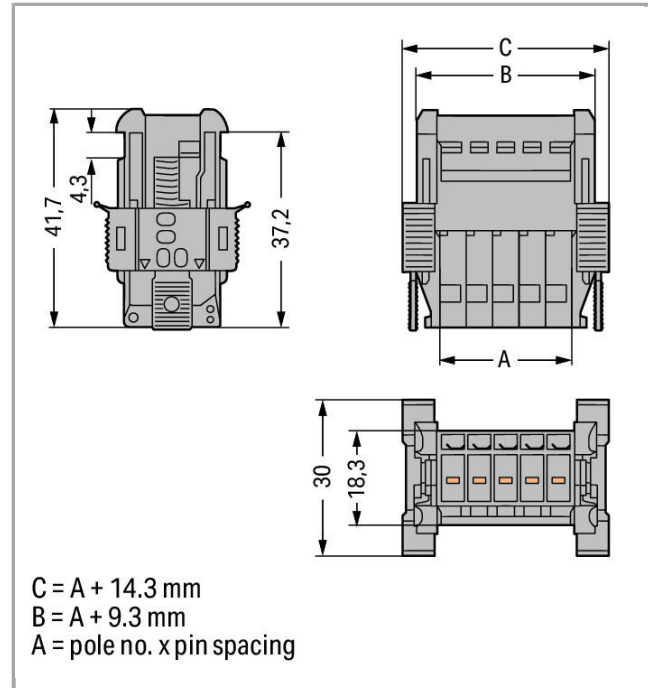

## Data

### Electrical data

#### Ratings per IEC/EN 60664-1

Rated voltage (III / 3)	500 V
Rated impulse voltage (III / 3)	6 kV
Rated current	32 A

### Connection data

Connection technology	CAGE CLAMP®
Actuation type	Operating tool
Connectable conductor materials	Copper
Nominal cross section	4 mm <sup>2</sup>
Solid conductor	0.08 ... 4 mm <sup>2</sup> / 28 ... 12 AWG
Fine-stranded conductor	0.08 ... 4 mm <sup>2</sup> / 28 ... 12 AWG
Strip length	8 ... 9 mm / 0.31 ... 0.35 inch

No. of poles	6
Total number of connection points	6
Total number of potentials	6
Type of wiring	Side-entry wiring

### Geometrical Data

Pin spacing	5 mm / 0.197 inch
Width	44.3 mm / 1.744 inch
Height	30 mm / 1.181 inch
Depth	41.7 mm / 1.642 inch

### Mechanical data

Mounting type	Snap-in
---------------	---------

### Plug connection

Contact type (pluggable connector)	Male connector/plug
Connector connection type	for conductors

### Material Data

Color	gray
Insulating material	Polyamide 66 (PA 66)
Fire load	0.5 MJ
Weight	22.637 g

### Commercial data

Product Group	18 (X-COM-System)
Country of origin	PL
GTIN	4045454917036
Customs Tariff No.	85366990990

### Approvals / Certificates



#### Country specific Approvals

Logo	Approval	Additional Approval Text	Certificate name
	CCA DEKRA Certification B.V.	EN 61984	2190419.02
	CCA DEKRA Certification B.V.	IEC 61984	NL-47799
	CSA	C22.2 No. 158	1101144



DEKRA Certification B.V.

## UL-Approvals

Logo	Approval	Additional Approval Text	Certificate name
	UR Underwriters Laboratories Inc.	UL 1977	E45171
	UR Underwriters Laboratories Inc.	UL 1059	E45172

## Compatible products





## Protective Warning Marker

















	Item no.: 280-415 Protective warning marker; with high-voltage symbol, black; for 5 terminal blocks	280-415
--	--	---------

## Coding

	Item no.: 769-435 Coding pin; for coding of female plugs; for carrier terminal blocks / male connectors	769-435
--	--	---------

## Marking accessories

	Item no.: 2009-145 Mini-WSB Inline; for Smart Printer; on reel; stretchable 5 - 5.2 mm; plain; snap-on type	2009-145
	Item no.: 2009-145/000-002 Mini-WSB Inline; for Smart Printer; on reel; stretchable 5 - 5.2 mm; plain; snap-on type	2009-145 /000-002
	Item no.: 2009-145/000-005 Mini-WSB Inline; for Smart Printer; on reel; stretchable 5 - 5.2 mm; plain; snap-on type	2009-145 /000-005
	Item no.: 2009-145/000-006 Mini-WSB Inline; for Smart Printer; on reel; stretchable 5 - 5.2 mm; plain; snap-on type	2009-145 /000-006

	<b>Item no.: 2009-145/000-007</b> Mini-WSB Inline; for Smart Printer; on reel; stretchable 5 - 5.2 mm; plain; snap-on type	2009-145	/000-007
	<b>Item no.: 2009-145/000-012</b> Mini-WSB Inline; for Smart Printer; on reel; stretchable 5 - 5.2 mm; plain; snap-on type	2009-145	/000-012
	<b>Item no.: 2009-145/000-023</b> Mini-WSB Inline; for smartPRINTER; on reel; stretchable 5 - 5.2 mm; plain; snap-on type	2009-145	/000-023
	<b>Item no.: 2009-145/000-024</b> Mini-WSB Inline; for Smart Printer; on reel; stretchable 5 - 5.2 mm; plain; snap-on type	2009-145	/000-024
	<b>Item no.: 210-831</b> Marking strips; on reel; 2.3 mm wide; plain; Self-adhesive	210-831	
	<b>Item no.: 210-832</b> Marking strips; on reel; 3 mm wide; plain; Self-adhesive	210-832	
	<b>Item no.: 210-833</b> Marking strips; on reel; 6 mm wide; plain; Self-adhesive	210-833	
	<b>Item no.: 210-834</b> Marking strips; on reel; 5 mm wide; plain; Self-adhesive	210-834	
	<b>Item no.: 248-501</b> Miniature WSB Quick marking system; plain; Marker width 5 mm; 10 strips with 10 markers per card	248-501	
	<b>Item no.: 248-501/000-002</b> Mini-WSB marking card; as card; not stretchable; plain; snap-on type	248-501	/000-002
	<b>Item no.: 248-501/000-005</b> Mini-WSB marking card; as card; not stretchable; plain; snap-on type	248-501	/000-005
	<b>Item no.: 248-501/000-006</b> Mini-WSB marking card; as card; not stretchable; plain; snap-on type	248-501	/000-006
	<b>Item no.: 248-501/000-007</b> Mini-WSB marking card; as card; not stretchable; plain; snap-on type	248-501	/000-007
	<b>Item no.: 248-501/000-012</b> Mini-WSB marking card; as card; not stretchable; plain; snap-on type	248-501	/000-012
	<b>Item no.: 248-501/000-017</b> Mini-WSB marking card; as card; not stretchable; plain; snap-on type	248-501	/000-017
	<b>Item no.: 248-501/000-023</b> Mini-WSB marking card; as card; not stretchable; plain; snap-on type	248-501	/000-023



**Item no.: 248-501/000-024**  
Mini-WSB marking card; as card; not stretchable; plain; snap-on type

248-501  
/000-024

**Female plug**



**Item no.: 769-101**  
1-conductor female plug; 4 mm<sup>2</sup>; 1-pole

769-101



**Item no.: 769-101/000-016**  
1-conductor female plug; 4 mm<sup>2</sup>; 1-pole

769-101  
/000-016



**Item no.: 769-102**  
1-conductor female plug; 4 mm<sup>2</sup>; 2-pole

769-102



**Item no.: 769-102/000-036**  
1-conductor female plug; 4 mm<sup>2</sup>; 2-pole

769-102  
/000-036



**Item no.: 769-102/000-037**  
1-conductor female plug; 4 mm<sup>2</sup>; 2-pole

769-102  
/000-037



**Item no.: 769-103**  
1-conductor female plug; 4 mm<sup>2</sup>; 3-pole

769-103



**Item no.: 769-103/000-036**  
1-conductor female plug; 4 mm<sup>2</sup>; 3-pole

769-103  
/000-036



**Item no.: 769-103/000-037**  
1-conductor female plug; 4 mm<sup>2</sup>; 3-pole

769-103  
/000-037



**Item no.: 769-103/000-038**  
1-conductor female plug; 4 mm<sup>2</sup>; 3-pole

769-103  
/000-038



**Item no.: 769-103/000-039**  
1-conductor female plug; 4 mm<sup>2</sup>; 3-pole

769-103  
/000-039



**Item no.: 769-104**  
1-conductor female plug; 4 mm<sup>2</sup>; 4-pole

769-104



**Item no.: 769-104/000-036**  
1-conductor female plug; 4 mm<sup>2</sup>; 4-pole

769-104  
/000-036

















**Item no.: 769-104/000-037**  
1-conductor female plug; 4 mm<sup>2</sup>; 4-pole



















769-104  
/000-037



**Item no.: 769-104/000-038**  
1-conductor female plug; 4 mm<sup>2</sup>; 4-pole

769-104  
/000-038

	<b>Item no.: 769-104/000-039</b> 1-conductor female plug; 4 mm <sup>2</sup> ; 4-pole		769-104
		/000-039	
	<b>Item no.: 769-105</b> 1-conductor female plug; 4 mm <sup>2</sup> ; 5-pole		769-105
	<b>Item no.: 769-105/000-036</b> 1-conductor female plug; 4 mm <sup>2</sup> ; 5-pole		769-105
		/000-036	
	<b>Item no.: 769-105/000-037</b> 1-conductor female plug; 4 mm <sup>2</sup> ; 5-pole		769-105
		/000-037	
	<b>Item no.: 769-105/000-038</b> 1-conductor female plug; 4 mm <sup>2</sup> ; 5-pole		769-105
		/000-038	
	<b>Item no.: 769-105/000-039</b> 1-conductor female plug; 4 mm <sup>2</sup> ; 5-pole		769-105
		/000-039	
	<b>Item no.: 769-106</b> 1-conductor female plug; 4 mm <sup>2</sup> ; 6-pole		769-106
	<b>Item no.: 769-106/000-006</b> 1-conductor female plug; 4 mm <sup>2</sup> ; 6-pole		769-106
		/000-006	
	<b>Item no.: 769-106/000-036</b> 1-conductor female plug; 4 mm <sup>2</sup> ; 6-pole		769-106
		/000-036	
	<b>Item no.: 769-106/000-037</b> 1-conductor female plug; 4 mm <sup>2</sup> ; 6-pole		769-106
		/000-037	
	<b>Item no.: 769-106/000-038</b> 1-conductor female plug; 4 mm <sup>2</sup> ; 6-pole		769-106
		/000-038	
	<b>Item no.: 769-106/000-039</b> 1-conductor female plug; 4 mm <sup>2</sup> ; 6-pole		769-106
		/000-039	
	<b>Item no.: 769-106/021-000</b> 1-conductor female plug; Locking lever; 4 mm <sup>2</sup> ; 6-pole		769-106
		/021-000	
	<b>Item no.: 769-121</b> 2-conductor female connector; 4 mm <sup>2</sup> ; 1-pole		769-121
	<b>Item no.: 769-121/000-016</b> 2-conductor female connector; 4 mm <sup>2</sup> ; 1-pole		769-121
		/000-016	

	<b>Item no.: 769-122</b> 2-conductor female connector; 4 mm <sup>2</sup> ; 2-pole	769-122
	<b>Item no.: 769-123</b> 2-conductor female connector; 4 mm <sup>2</sup> ; 3-pole	769-123
	<b>Item no.: 769-124</b> 2-conductor female connector; 4 mm <sup>2</sup> ; 4-pole	769-124
	<b>Item no.: 769-125</b> 2-conductor female connector; 4 mm <sup>2</sup> ; 5-pole	769-125
	<b>Item no.: 769-126</b> 2-conductor female connector; 4 mm <sup>2</sup> ; 6-pole	769-126
<b>tools</b>		
	<b>Item no.: 210-490</b> Operating tool; for female and male connectors with CAGE CLAMP® connection	210-490
	<b>Item no.: 769-434</b> Push-button; loose; for female and male connectors with CAGE CLAMP® connection	769-434
<b>ferrule</b>		
	<b>Item no.: 216-101</b> Ferrule; Sleeve for 0.5 mm <sup>2</sup> / AWG 22; uninsulated; electro-tin plated	216-101
	<b>Item no.: 216-102</b> Ferrule; Sleeve for 0.75 mm <sup>2</sup> / AWG 20; uninsulated; electro-tin plated	216-102
	<b>Item no.: 216-103</b> Ferrule; Sleeve for 1 mm <sup>2</sup> / AWG 18; uninsulated; electro-tin plated	216-103
	<b>Item no.: 216-104</b> Ferrule; Sleeve for 1.5 mm <sup>2</sup> / AWG 16; uninsulated; electro-tin plated	216-104
	<b>Item no.: 216-201</b> Ferrule; Sleeve for 0.5 mm <sup>2</sup> / 20 AWG; insulated; electro-tin plated	216-201
	<b>Item no.: 216-202</b> Ferrule; Sleeve for 0.75 mm <sup>2</sup> / 18 AWG; insulated; electro-tin plated	216-202
	<b>Item no.: 216-203</b> Ferrule; Sleeve for 1 mm <sup>2</sup> / AWG 18; insulated; electro-tin plated	216-203
	<b>Item no.: 216-204</b> Ferrule; Sleeve for 1.5 mm <sup>2</sup> / AWG 16; insulated; electro-tin plated	216-204
	<b>Item no.: 216-206</b> Ferrule; Sleeve for 2.5 mm <sup>2</sup> / AWG 14; insulated; electro-tin plated	216-206
<b>Insulation stop</b>		
	<b>Item no.: 769-470</b> Insulation stop; 0.08 - 0.2 mm <sup>2</sup> "s" (0.14 mm <sup>2</sup> "f-st"); 5 pieces/strip	769-470
	<b>Item no.: 769-471</b> Insulation stop; 0.25 - 0.5 mm <sup>2</sup> ; 5 pieces/strip	769-471
	<b>Item no.: 769-472</b> Insulation stop; 0.75 - 1 mm <sup>2</sup> ; 5 pieces/strip	769-472

---

Strain relief plate



Item no.: 769-410  
Strain relief plate

769-410



Item no.: 769-413  
Strain relief plate

769-413

---

Downloads

Documentation

Bid Text

769-606/006-000

doc  
25.6 kB

Download

---

CAD/CAE - Smart Data

CAD data

3D Download 769-606/006-000

URL

Download

---

Product family

**X-COM**

[Learn more about the product family.](#)

[Show all products from the family](#)

Subject to changes.

---