

Data Sheet | Item Number: 231-612

1-conductor male connector; CAGE CLAMP®; 2.5 mm²; Pin spacing 5 mm; 12-pole; gray

<https://www.wago.com/231-612>



Color: ■ gray

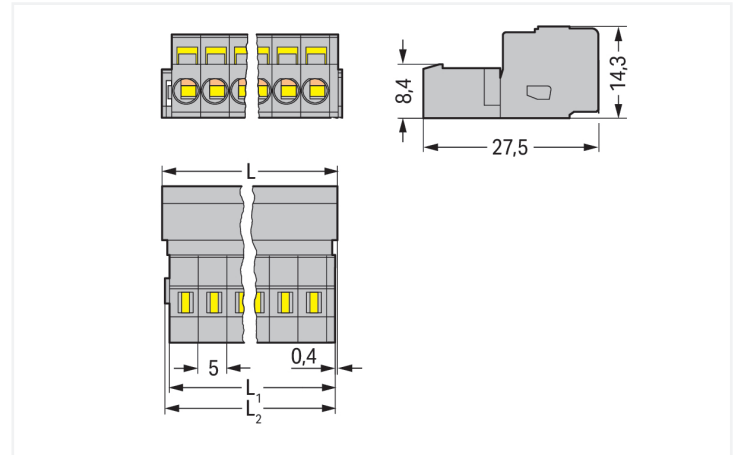

Dimensions in mm

$L = (\text{pole no.} - 1) \times \text{pin spacing} + 8.2 \text{ mm}$

$L1 = L - 1.7 \text{ mm}$

$L2 = L - 1.2 \text{ mm}$

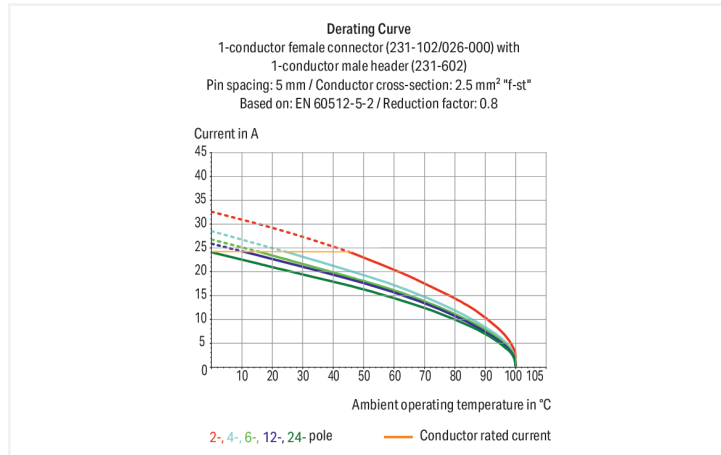

Stiftleiste Serie 231, grau

Die Stiftleiste hat die Artikelnummer 231-612 und verspricht eine fehlerfreie Elektroinstallation. Mit unseren Leiterplatten-Steckverbindern bekommen Sie ein universelles Steckverbindersystem, das vielseitig eingesetzt werden kann: als Leiterplatten-Steckverbinder, als Durchführungssteckverbinder, als fliegende Steckverbindung für verschiedene Montagearten oder als Steckverbinder auf Reihenklemmen. Für den Leiteranschluss werden bei dieser Stiftleiste Abisolierlängen von 8 bis 9 mm benötigt. Bei diesem Produkt findet die CAGE CLAMP®-Technologie Verwendung. Der zuverlässige und wartungsfreie CAGE CLAMP® Universalanschluss bietet die Möglichkeit, alle Arten von Leitern mit einer Käfigzugfeder anzuschließen, ohne, dass eine Vorbehandlung der Leiter erforderlich ist. Das Aufcrimpen von Aderendhülsen kann somit entfallen. Die Abmessungen sind in Breite x Höhe x Tiefe (63,2 x 14,3 x 27,5) mm. In Abhängigkeit von der Leiterart ist die Stiftleiste für Leiterquerschnitte von 0,08 mm² bis 2,5 mm² geeignet. Für die Kontaktfläche wurde Zinn verwendet. Diese Stiftleiste/Stecker wird durch ein Betätigungswerkzeug betätigt. Das MCS – "Multi Connection System" von WAGO ist ein vielfältiges Steckverbindersystem für Ihre durchgängige Systemverdrahtung. Es ermöglicht Ihnen eine vereinfachte Verdrahtung in der Kabelvorkonfektionierung und auf Geräten durch zwei Betätigungsrichtungen für die CAGE CLAMP®-Varianten.

Notes

Safety Information

The MCS – MULTI CONNECTION SYSTEM includes connectors without breaking capacity in accordance with DIN EN 61984. When used as intended, these connectors must not be connected/disconnected when live or under load. When used as intended, these connectors must not be connected/disconnected when live or under load. The circuit design should ensure header pins, which can be touched, are not live when unmated.

Variants:

Other pole numbers

Gold-plated or partially gold-plated contact surfaces

Other versions (or variants) can be requested from WAGO Sales or configured at <https://configurator.wago.com/>.

Electrical data

Ratings per	IEC/EN 60664-1		
Overvoltage category	III	III	II
Pollution degree	3	2	2
Nominal voltage	320 V	320 V	630 V
Rated impulse withstand voltage	4 kV	4 kV	4 kV
Rated current	12 A	12 A	12 A

Approvals per	UL 1059		
Use group	B	C	D
Rated voltage	300 V	-	300 V
Rated current	15 A	-	10 A

Approvals per	UL 1977
Rated voltage	600 V
Rated current	15 A

Approvals per	CSA		
Use group	B	C	D
Rated voltage	300 V	-	300 V
Rated current	15 A	-	10 A

Connection data

Clamping units	12
Total number of potentials	12
Number of connection types	1
Number of levels	1

Connection 1	
Connection technology	CAGE CLAMP®
Actuation type	Operating tool
Actuation direction 1	Operation parallel to conductor entry
Actuation direction 2	Operation perpendicular to conductor entry
Solid conductor	0.08 ... 2.5 mm ² / 28 ... 12 AWG
Fine-stranded conductor	0.08 ... 2.5 mm ² / 28 ... 12 AWG
Fine-stranded conductor; with insulated ferrule	0.25 ... 1.5 mm ²
Fine-stranded conductor; with uninsulated ferrule	0.25 ... 2.5 mm ²
Strip length	8 ... 9 mm / 0.31 ... 0.35 inches
Pole number	12
Conductor entry direction to mating direction	0°

Physical data

Pin spacing	5 mm / 0.197 inches
Width	63.2 mm / 2.488 inches
Height	14.3 mm / 0.563 inches
Depth	27.5 mm / 1.083 inches

Mechanical data

Variable coding	Yes
Anti-rotation protection	Yes

Plug-in connection

Contact type (pluggable connector)	Male connector/plug
Connector (connection type)	for conductor
Mismatching protection	No

Material data

Note (material data)	Information on material specifications can be found here
Color	gray
Material group	I
Insulation material (main housing)	Polyamide (PA66)
Flammability class per UL94	V0
Clamping spring material	Chrome-nickel spring steel (CrNi)
Contact material	Electrolytic copper (E _{Cu})
Contact Plating	Tin
Fire load	0.317 MJ
Weight	18 g

Environmental requirements

Limit temperature range	-60 ... +100 °C	Environmental Testing	
Processing temperature	-35 ... +60 °C	Test specification:	DIN EN 50155 (VDE 0115-200):2022-06
		Railway applications – Rolling stock – Electronic equipment	
		Test procedure:	DIN EN 61373 (VDE 0115-0106):2011-04
		Railway applications – Rolling stock equipment – Vibration and shock tests	
		Spectrum/Mounting location	Service life test, Category 1, Class A/B
		Functional test with noise-like oscillations	Test passed according to Section 8 of the standard
		Frequency	f ₁ = 5 Hz to f ₂ = 150 Hz
		Acceleration	0.101g (highest test level used for all axes)
		Test duration per axis	10 min.
		Test directions	X, Y and Z axes
		Monitoring of contact faults and interruptions	Passed
		Voltage drop measurement before and after each axis	Passed
		Simulated service life test through increased levels of noise-like oscillations	Test passed according to Section 9 of the standard
		Frequency	f ₁ = 5 Hz to f ₂ = 150 Hz
		Acceleration	0.572g (highest test level used for all axes)
		Test duration per axis	5 h
		Test directions	X, Y and Z axes
		Extended testing: Monitoring of contact faults and interruptions	Passed
		Extended testing: Voltage drop measurement before and after each axis	Passed
		Shock test	Test passed according to Section 10 of the standard
		Shock pulse form	Half sine
		Acceleration	5g (highest test level used for all axes)
		Shock duration	30 ms
		Number of shocks (per axis)	3 pos. und 3 neg.
		Test directions	X, Y and Z axes
		Extended testing: Monitoring of contact faults and interruptions	Passed
		Extended testing: Voltage drop measurement before and after each axis	Passed
		Vibration and shock stress for rolling stock equipment	Passed

Commercial data

Product Group	3 (Multi Conn. System)
PU (SPU)	25 pcs
Packaging type	Box
Country of origin	DE
GTIN	4044918258302
Customs tariff number	85366930000

Product Classification

UNSPSC	39121409
eCl@ss 10.0	27-44-03-09
eCl@ss 9.0	27-44-03-09
ETIM 9.0	EC002638
ETIM 8.0	EC002638
ECCN	NO US CLASSIFICATION

Environmental Product Compliance

RoHS Compliance Status	Compliant, No Exemption
------------------------	-------------------------

Approvals / Certificates

General approvals



Approval	Standard	Certificate Name
CB DEKRA Certification B.V.	IEC 61984	NL-113351
CSA DEKRA Certification B.V.	C22.2	1466354
KEMA/KEUR DEKRA Certification B.V.	EN 61984	71-130478 REV.1
UL Underwriters Laboratories Inc.	UL 1059	UL-US- L45172-6187117-81111991-1
UR Underwriters Laboratories Inc.	UL 1977	E45171

Declarations of conformity and manufacturer's declarations



Approval	Standard	Certificate Name
Railway WAGO GmbH & Co. KG	-	Railway Ready

Approvals for marine applications



Approval	Standard	Certificate Name
ABS American Bureau of Ship- ping	-	24-0095975-PDA
DNV DNV GL SE	-	TAE000016Z
LR Lloyds Register	IEC 61984	96/20035 (E5)

Downloads			
Environmental Product Compliance			
Compliance Search			
Environmental Product Compliance 231-612			↓
Documentation			
Additional Information			
Technical Section	03.04.2019	pdf 2027.26 KB	↓
CAD/CAE-Data			
CAD data		CAE data	
2D/3D Models 231-612		EPLAN Data Portal 231-612	
		↓	
		ZUKEN Portal 231-612	
		↓	
1 Compatible Products			
1.1 System counterpart			
1.1.1 Female connector/socket			
Item No.: 232-112/026-000 1-conductor female connector, angled; CAGE CLAMP®; 2.5 mm²; Pin spacing 5 mm; 12-pole; 2,50 mm²; gray	Item No.: 232-212/026-000 1-conductor female connector, angled; CAGE CLAMP®; 2.5 mm²; Pin spacing 5 mm; 12-pole; 2,50 mm²; gray	Item No.: 731-512/031-000 1-conductor female connector, angled; CAGE CLAMP®; 2.5 mm²; Pin spacing 5 mm; 12-pole; clamping collar; DIN-35 rail/ panel mounting; 2,50 mm²; gray	Item No.: 731-512/008-000 1-conductor female connector, angled; CAGE CLAMP®; 2.5 mm²; Pin spacing 5 mm; 12-pole; Snap-in mounting feet; 2,50 mm²; gray
Item No.: 231-112/027-000 1-conductor female connector; CAGE CLAMP®; 2.5 mm²; Pin spacing 5 mm; 12-pole; clamping collar; gray	Item No.: 231-112/031-000 1-conductor female connector; CAGE CLAMP®; 2.5 mm²; Pin spacing 5 mm; 12-pole; clamping collar; gray	Item No.: 231-112/026-000 1-conductor female connector; CAGE CLAMP®; 2.5 mm²; Pin spacing 5 mm; 12-pole; gray	Item No.: 231-112/037-000 1-conductor female connector; CAGE CLAMP®; 2.5 mm²; Pin spacing 5 mm; 12-pole; Lateral locking levers; gray
Item No.: 231-112/125-000 1-conductor female connector; CAGE CLAMP®; 2.5 mm²; Pin spacing 5 mm; 12-pole; Snap-in flange; gray	Item No.: 231-112/008-000 1-conductor female connector; CAGE CLAMP®; 2.5 mm²; Pin spacing 5 mm; 12-pole; Snap-in mounting feet; gray	Item No.: 231-112/102-000 1-conductor female connector; CAGE CLAMP®; 2.5 mm²; Pin spacing 5 mm; 12-pole; with integrated end plate; gray	Item No.: 2231-1112/327-000 1-conductor female connector; lever; Push-in CAGE CLAMP®; 2.5 mm²; Pin spacing 5 mm; 12-pole; 2,50 mm²; gray
Item No.: 2231-1112/329-000 1-conductor female connector; lever; Push-in CAGE CLAMP®; 2.5 mm²; Pin spacing 5 mm; 12-pole; Centered locking levers; gray	Item No.: 2231-1112/329-000/336-000 1-conductor female connector; lever; Push-in CAGE CLAMP®; 2.5 mm²; Pin spacing 5 mm; 12-pole; Centered locking levers; Strain relief plate; gray	Item No.: 2231-1112/327-047 1-conductor female connector; lever; Push-in CAGE CLAMP®; 2.5 mm²; Pin spacing 5 mm; 12-pole; direct marking; 2,50 mm²; gray	Item No.: 2231-1112/038-000 1-conductor female connector; lever; Push-in CAGE CLAMP®; 2.5 mm²; Pin spacing 5 mm; 12-pole; Lateral locking levers; 2,50 mm²; gray
Item No.: 2231-1112/038-000/336-000 1-conductor female connector; lever; Push-in CAGE CLAMP®; 2.5 mm²; Pin spacing 5 mm; 12-pole; Lateral locking levers; Strain relief plate; gray	Item No.: 2231-1112/327-000/336-000 1-conductor female connector; lever; Push-in CAGE CLAMP®; 2.5 mm²; Pin spacing 5 mm; 12-pole; Strain relief plate; gray	Item No.: 2231-112/026-000 1-conductor female connector; push-button; Push-in CAGE CLAMP®; 2.5 mm²; Pin spacing 5 mm; 12-pole; 2,50 mm²; gray	Item No.: 2231-112/031-000 1-conductor female connector; push-button; Push-in CAGE CLAMP®; 2.5 mm²; Pin spacing 5 mm; 12-pole; clamping collar; 2,50 mm²; gray

1.1.1 Female connector/socket



Item No.: 2231-112/037-000
1-conductor female connector; push-button; Push-in CAGE CLAMP®; 2.5 mm²; Pin spacing 5 mm; 12-pole; Lateral locking levers; 2,50 mm²; gray

Item No.: 2231-112/008-000
1-conductor female connector; push-button; Push-in CAGE CLAMP®; 2.5 mm²; Pin spacing 5 mm; 12-pole; Snap-in mounting feet; 2,50 mm²; gray

Item No.: 2231-112/102-000
1-conductor female connector; push-button; Push-in CAGE CLAMP®; 2.5 mm²; Pin spacing 5 mm; 12-pole; with integrated end plate; 2,50 mm²; gray

Item No.: 231-2112/037-000
2-conductor female connector; Push-in CAGE CLAMP®; 2.5 mm²; Pin spacing 5 mm; 12-pole; Lateral locking levers; gray



Item No.: 231-2112/026-000
2-conductor female connector; Push-in CAGE CLAMP®; 2.5 mm²; Pin spacing 5 mm; 12-pole; with integrated end plate; gray

Item No.: 232-242/005-000/039-000
Female connector for rail-mount terminal blocks; 0.6 x 1 mm pins; angled; Locking lever; Pin spacing 5 mm; 12-pole; gray

Item No.: 232-242/005-000
Female connector for rail-mount terminal blocks; 0.6 x 1 mm pins; angled; Pin spacing 5 mm; 12-pole; gray

Item No.: 232-142/005-000/039-000
Female connector for rail-mount terminal blocks; 0.6 x 1 mm pins; straight; Locking lever; Pin spacing 5 mm; 12-pole; gray



Item No.: 232-142/005-000
Female connector for rail-mount terminal blocks; 0.6 x 1 mm pins; straight; Pin spacing 5 mm; 12-pole; gray

Item No.: 232-242
THT female header; angled; Pin spacing 5 mm; 12-pole; 0.6 x 1.0 mm solder pin; gray

Item No.: 232-242/031-000
THT female header; angled; Pin spacing 5 mm; 12-pole; clamping collar; 0.6 x 1.0 mm solder pin; gray

Item No.: 232-242/039-000
THT female header; angled; Pin spacing 5 mm; 12-pole; Locking lever; 0.6 x 1.0 mm solder pin; gray



Item No.: 232-242/047-000
THT female header; angled; Pin spacing 5 mm; 12-pole; Spacer flange; 0.6 x 1.0 mm solder pin; gray

Item No.: 232-142
THT female header; straight; Pin spacing 5 mm; 12-pole; 0.6 x 1.0 mm solder pin; gray

Item No.: 232-142/031-000
THT female header; straight; Pin spacing 5 mm; 12-pole; clamping collar; 0.6 x 1.0 mm solder pin; gray

Item No.: 232-142/039-000
THT female header; straight; Pin spacing 5 mm; 12-pole; Locking lever; 0.6 x 1.0 mm solder pin; gray



Item No.: 232-142/047-000
THT female header; straight; Pin spacing 5 mm; 12-pole; Spacer flange; 0.6 x 1.0 mm solder pin; gray

1.2 Optional Accessories

1.2.1 Coding

1.2.1.1 Coding



Item No.: 231-129
Coding key; snap-on type; light gray

1.2.2 Cover

1.2.2.1 Cover



Item No.: 231-668
Lockout caps; for covering unused clamping units; gray

1.2.3 Ferrule

1.2.3.1 Ferrule



Item No.: 216-301

Ferrule; Sleeve for 0.25 mm² / AWG 24; insulated; electro-tin plated; yellow

Item No.: 216-302

Ferrule; Sleeve for 0.34 mm² / 22 AWG; insulated; electro-tin plated; light turquoise

Item No.: 216-201

Ferrule; Sleeve for 0.5 mm² / 20 AWG; insulated; electro-tin plated; electrolytic copper; acc. to DIN 46228, Part 4/09.90; white

Item No.: 216-241

Ferrule; Sleeve for 0.5 mm² / 20 AWG; insulated; electro-tin plated; electrolytic copper; gastight crimped; acc. to DIN 46228, Part 4/09.90; white



Item No.: 216-141

Ferrule; Sleeve for 0.5 mm² / 20 AWG; un-insulated; electro-tin plated; electrolytic copper; gastight crimped; acc. to DIN 46228, Part 1/08.92

Item No.: 216-101

Ferrule; Sleeve for 0.5 mm² / AWG 22; un-insulated; electro-tin plated; silver-colored

Item No.: 216-242

Ferrule; Sleeve for 0.75 mm² / 18 AWG; insulated; electro-tin plated; electrolytic copper; gastight crimped; acc. to DIN 46228, Part 4/09.90; gray

Item No.: 216-262

Ferrule; Sleeve for 0.75 mm² / 18 AWG; insulated; electro-tin plated; electrolytic copper; gastight crimped; acc. to DIN 46228, Part 4/09.90; gray



Item No.: 216-202

Ferrule; Sleeve for 0.75 mm² / 18 AWG; insulated; electro-tin plated; gray

Item No.: 216-142

Ferrule; Sleeve for 0.75 mm² / 18 AWG; un-insulated; electro-tin plated; electrolytic copper; gastight crimped; acc. to DIN 46228, Part 1/08.92

Item No.: 216-102

Ferrule; Sleeve for 0.75 mm² / AWG 20; un-insulated; electro-tin plated; silver-colored

Item No.: 216-243

Ferrule; Sleeve for 1 mm² / AWG 18; insulated; electro-tin plated; electrolytic copper; gastight crimped; acc. to DIN 46228, Part 4/09.90; red



Item No.: 216-263

Ferrule; Sleeve for 1 mm² / AWG 18; insulated; electro-tin plated; electrolytic copper; gastight crimped; acc. to DIN 46228, Part 4/09.90; red

Item No.: 216-203

Ferrule; Sleeve for 1 mm² / AWG 18; insulated; electro-tin plated; red

Item No.: 216-103

Ferrule; Sleeve for 1 mm² / AWG 18; un-insulated; electro-tin plated

Item No.: 216-143

Ferrule; Sleeve for 1 mm² / AWG 18; un-insulated; electro-tin plated; electrolytic copper; gastight crimped; acc. to DIN 46228, Part 1/08.92



Item No.: 216-204

Ferrule; Sleeve for 1.5 mm² / AWG 16; insulated; electro-tin plated; black

Item No.: 216-244

Ferrule; Sleeve for 1.5 mm² / AWG 16; insulated; electro-tin plated; electrolytic copper; gastight crimped; acc. to DIN 46228, Part 4/09.90; black

Item No.: 216-264

Ferrule; Sleeve for 1.5 mm² / AWG 16; insulated; electro-tin plated; electrolytic copper; gastight crimped; acc. to DIN 46228, Part 4/09.90; black

Item No.: 216-284

Ferrule; Sleeve for 1.5 mm² / AWG 16; insulated; electro-tin plated; electrolytic copper; gastight crimped; acc. to DIN 46228, Part 4/09.90; black



Item No.: 216-144

Ferrule; Sleeve for 1.5 mm² / AWG 16; un-insulated; electro-tin plated; electrolytic copper; gastight crimped; acc. to DIN 46228, Part 1/08.92; silver-colored

Item No.: 216-104

Ferrule; Sleeve for 1.5 mm² / AWG 16; un-insulated; electro-tin plated; silver-colored

Item No.: 216-106

Ferrule; Sleeve for 2.5 mm² / AWG 14; un-insulated; electro-tin plated; silver-colored

1.2.4 Insulation stop

1.2.4.1 Insulation stop



Item No.: 231-670

Insulation stop; 0.08-0.2 mm² / 0.2 mm² "s"; white

Item No.: 231-671

Insulation stop; 0.25 - 0.5 mm²; light gray

Item No.: 231-672

Insulation stop; 0.75 - 1 mm²; dark gray

1.2.5 Jumper

1.2.5.1 Jumper



Item No.: 231-910

Jumper; for conductor entry; 10-way; insulated; gray



Item No.: 231-902

Jumper; for conductor entry; 2-way; insulated; gray



Item No.: 231-903

Jumper; for conductor entry; 3-way; insulated; gray



Item No.: 231-905

Jumper; for conductor entry; 5-way; insulated; gray



Item No.: 231-907

Jumper; for conductor entry; 7-way; insulated; gray

1.2.6 Marking

1.2.6.1 Marking strip



Item No.: 210-331/500-103

Marking strips; as a DIN A4 sheet; MARKED; 1-12 (300x); Height of marker strip: 2.3 mm/0.091 in; Strip length 182 mm; Horizontal marking; Self-adhesive; white



Item No.: 210-332/500-202

Marking strips; as a DIN A4 sheet; MARKED; 1-16 (160x); Height of marker strip: 3 mm; Strip length 182 mm; Horizontal marking; Self-adhesive; white



Item No.: 210-332/500-205

Marking strips; as a DIN A4 sheet; MARKED; 1-32 (80x); Height of marker strip: 3 mm; Strip length 182 mm; Horizontal marking; Self-adhesive; white



Item No.: 210-331/500-104

Marking strips; as a DIN A4 sheet; MARKED; 13-24 (300x); Height of marker strip: 2.3 mm/0.091 in; Strip length 182 mm; Horizontal marking; Self-adhesive; white



Item No.: 210-332/500-204

Marking strips; as a DIN A4 sheet; MARKED; 17-32 (160x); Height of marker strip: 3 mm; Strip length 182 mm; Horizontal marking; Self-adhesive; white



Item No.: 210-332/500-206

Marking strips; as a DIN A4 sheet; MARKED; 33-48 (160x); Height of marker strip: 3 mm; Strip length 182 mm; Horizontal marking; Self-adhesive; white

1.2.7 Strain relief

1.2.7.1 Strain relief housing



Item No.: 232-612

Strain relief housing; for female and male connectors; 2 parts; Pin spacing 5 mm; 12-pole; gray

1.2.8 Tool

1.2.8.1 Operating tool



Item No.: 231-231

Combination operating tool; red



Item No.: 210-720

Operating tool; Blade: 3.5 x 0.5 mm; with a partially insulated shaft; multicoloured



Item No.: 210-657

Operating tool; Blade: 3.5 x 0.5 mm; with a partially insulated shaft; short; multicoloured



Item No.: 209-132

Operating tool; for connecting comb-style jumper bar; made of insulating material; 2-way; natural



Item No.: 210-250

Operating tool; for MCS MINI and MIDI with CAGE CLAMP® connection; red



Item No.: 280-440

Operating tool; made of insulating material; 10-way; white



Item No.: 209-130

Operating tool; made of insulating material; 1-way; for 264 Series (1-/2-way), 280, 281 Series (up to 3-way); natural



Item No.: 231-291

Operating tool; made of insulating material; 1-way; loose; red

1.2.8.1 Operating tool



Item No.: 231-131
Operating tool; made of insulating material; 1-way; loose; white



Item No.: 280-432
Operating tool; made of insulating material; 2-way; white



Item No.: 280-433
Operating tool; made of insulating material; 3-way; white



Item No.: 280-434
Operating tool; made of insulating material; 4-way; white



Item No.: 280-435
Operating tool; made of insulating material; 5-way; gray



Item No.: 280-436
Operating tool; made of insulating material; 6-way; white



Item No.: 280-437
Operating tool; made of insulating material; 7-way; white



Item No.: 280-438
Operating tool; made of insulating material; 8-way; white



Item No.: 231-159
Operating tool; natural

Installation Notes

Conductor termination

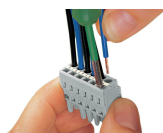

Inserting a conductor via 3.5 mm screwdriver – CAGE CLAMP® actuation parallel to conductor entry.

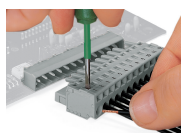

Inserting a conductor via 3.5 mm screwdriver – CAGE CLAMP® actuation perpendicular to conductor entry.

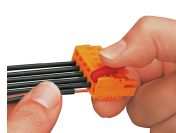

Inserting a conductor into CAGE CLAMP® unit via operating tool (231-291).

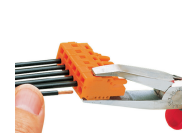

Inserting a conductor via operating tool.

Coding

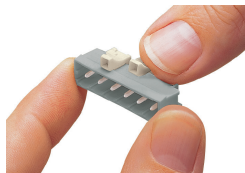

Coding a male header – fitting coding key(s).

Testing

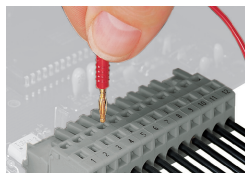

Testing – female connector with CAGE CLAMP®
Integrated test ports for testing perpendicular to conductor entry via 2 or 2.3 mm Ø test plug

Installation

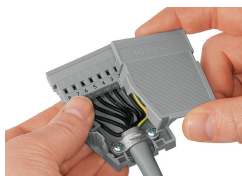
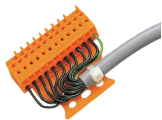

Male connector with strain relief plate

Strain relief housing shown with a male connector equipped with CAGE CLAMP®

Marking

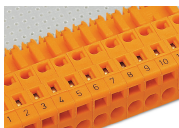

Labeling via direct marking or self-adhesive strips.