

Item no.: 232-208/026-000  
 Product description: ANGLED FEMALE PLUG; 8 POLE; PIN SPACING 5 MM / 0.197 IN; WITH CODIG FINGERS; WITH INTEGRATED FIXING FLANGES; CONDUCTOR EXIT SAME DIRECTION AS LATCHES

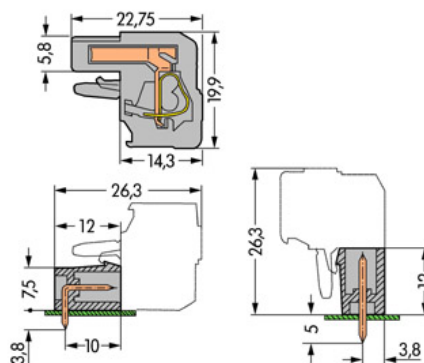

Packing unit 50 pieces

Product group	3 (Multi Conn. System)
Pin spacing from	5 mm
Pin spacing from	0,197 in
pole count	8
Cross section from [mm <sup>2</sup> ]	0,08 mm <sup>2</sup>
Cross section to [mm <sup>2</sup> ]	2,5 mm <sup>2</sup>
Cross section from [AWG]	28 AWG
Cross section to [AWG]	12 AWG
Connection method	CAGE CLAMP®CONNECTION
Measured voltage EN	250 V
Measured shock voltage	4 kV
Pollution degree	3
Current intensity EN	14 A
Weight	15,07 g
Color	grey
No. of connection Points	8
No. of potentials	8
Height	19,9 mm
Height	0,783 in
Width	42,4 mm
Width	1,669 in
Depth	22,75 mm



Depth	0,896 in
Strip length from	8 mm
Strip length to	9 mm
Strip length	0,33 in



Item number	Admission office	Approval no.	Voltage [V]	Current [A]	Cross section [ mm <sup>2</sup> ]
232-208/026-000	BV	11915/A0	400	16	2,5
232-208/026-000	CCA	5764	250	16	0,08-2,5
232-208/026-000	CSA	154112-1466354	300	15	22-12
232-208/026-000	DEMKO	88126	250		2,5
232-208/026-000	KEMA	2083746.02	250	16	0,08-2,5
232-208/026-000	KR	HMB05880-EL003	250/400	12/16	2,5
232-208/026-000	NEMKO	P94101840	250		2,5
232-208/026-000	UR	E45171	600	15	12
232-208/026-000	UR	E45172	300	15	22-12

Sorting criteria: admission office - approval number

© WAGO Kontakttechnik GmbH & Co. KG

Specifications are subject to changes and errors may be expected