

Item no.: 231-620/019-000  
 Product description: MALE CONNECTOR; WITH FIXING FLANGE; 20 POLE; PIN SPACING 5 MM / 0.197 IN; FOR SCREW OR SIMILAR MOUNTING TYPES; CAGE CLAMP®CONNECTION

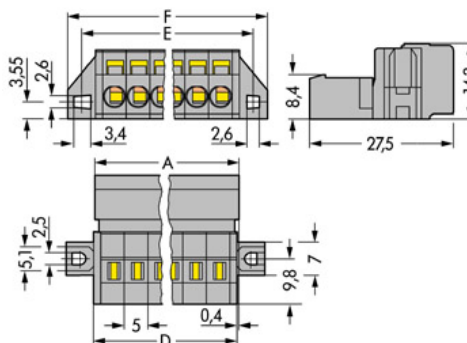

Packing unit 10 pieces

Product group	3 (Multi Conn. System)
Pin spacing from	5 mm
Pin spacing from	0,197 in
pole count	20
Cross section from [mm <sup>2</sup> ]	0,08 mm <sup>2</sup>
Cross section to [mm <sup>2</sup> ]	2,5 mm <sup>2</sup>
Cross section from [AWG]	28 AWG
Cross section to [AWG]	12 AWG
Connection method	CAGE CLAMP®CONNECTION
Measured voltage EN	250 V
Measured shock voltage	4 kV
Pollution degree	3
Current intensity EN	12 A
Weight	31,3 g
Color	grey
No. of connection Points	20
No. of potentials	20
Height	14,3 mm
Height	0,563 in
Width	114,8 mm
Width	4,52 in
Depth	27,5 mm



Depth	1,083 in
Strip length from	8 mm
Strip length to	9 mm
Strip length	0,33 in



Item number	Admission office	Approval no.	Voltage [V]	Current [A]	Cross section [ mm <sup>2</sup> ]
231-620/019-000	BV	11915/A0	400	16	2,5
231-620/019-000	CCA	5764	250	12	0,08-2,5
231-620/019-000	CSA	154112-1466354	300	15	22-12
231-620/019-000	DEMKO	88126	250		2,5
231-620/019-000	KEMA	2083746.02	250	12	0,08-2,5
231-620/019-000	KR	HMB05880-EL003	250/400	12/16	2,5
231-620/019-000	NEMKO	P94101840	250		2,5
231-620/019-000	UR	E45171	600	15	12
231-620/019-000	UR	E45172	300	15	22-12

Sorting criteria: admission office - approval number

© WAGO Kontakttechnik GmbH & Co. KG

Specifications are subject to changes and errors may be expected