

- Y5U Ceramic
- Surface Mount
- High CV
- +125°C
Maximum
Temperature

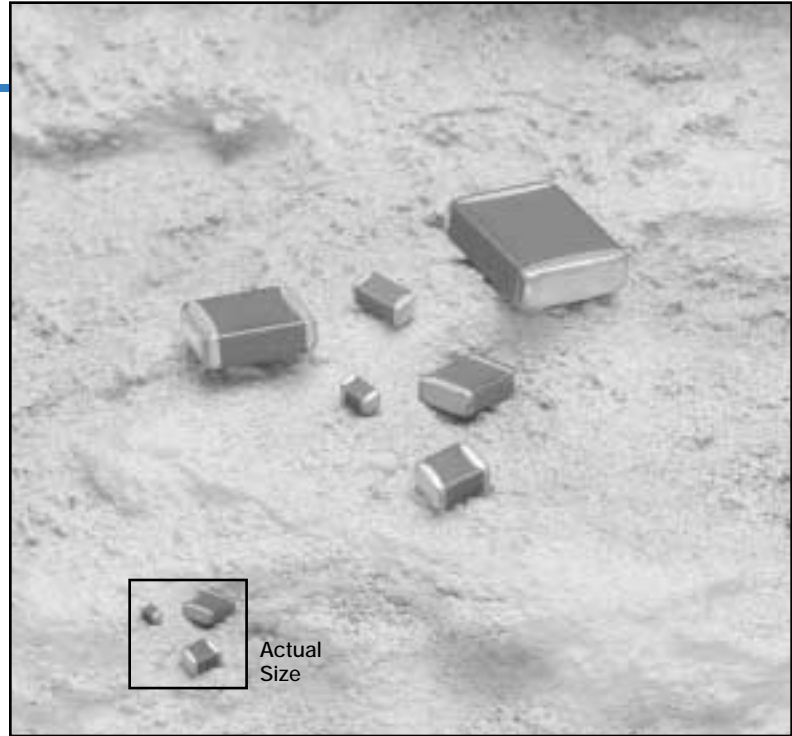

The THC series is a very high CV value multilayer ceramic chip capacitor available from UCC/NCC. These chip capacitors are designed for use in DC-DC converters, switching power supplies, or any other application requiring a very high capacitance, low impedance, surface mount capacitor. The THC series capacitors have a Y5U temperature coefficient, which allows for the high CV values. All of these capacitors are available with either silver or nickel barrier terminations.

Refer to Mini-Glossary at the end of the multilayer ceramic capacitors section for additional technical information and specifications.

Summary of Specifications

- Surface mount terminals.
- Capacitance range: 0.047 to 33 μ F.
- Voltage range: 25 to 100VDC.
- Operating temperature range: -55°C to +125°C.
- Standard capacitance tolerance: -20% to +80%
- Nominal case size (L x W x H): 2.0 x 1.25 x 1.25mm to 7.5 x 6.3 x 2.5mm.
- Rated lifetime: 1,000 hours at +125°C.

THC Series

THC Specifications

Item	Characteristics
Operating Temperature Range	-55 to +125°C
Rated Voltage Range	25 to 100VDC
Capacitance Range	0.047 to 33μF
Capacitance Tolerance	-20% to +80% (Z) at +20±2°C, 1±0.1kHz, and 1±0.2Vrms
Dissipation Factor (Tan δ)	5% maximum at +20±2°C, 1±0.1kHz, and 1±0.2Vrms
Ripple Current	At +125°C, the maximum ripple current at 10kHz-1MHz is specified in the Ratings Tables.
Withstand Voltage	No abnormality after applying 250% of the DC rated voltage for 1 to 5 seconds at +20±2°C.
Insulation Resistance	1,000 Ω•F or 10,000MΩ, whichever is less, after applying the DC rated voltage for 60±5 seconds at +20±2°C.
Solderability	Using eutectic solder containing Ag 3% at a solder temperature of +235±5°C and a dip time of 2±0.5 seconds, a minimum of 75% of the surface of the terminals shall be covered with new solder.
Soldering Heat Resistance	Using eutectic solder containing Ag 3% at a solder temperature of +260±5°C and a dip time of 5±0.5 seconds, the following specifications shall be satisfied when the capacitors are restored to +20°C. Appearance : no abnormality Capacitance change : ≤ -10% to +15% of initial measured value Tan δ (DF) : ≤ 5%
Humidity Load Life Test	The following specifications shall be satisfied when the capacitors are restored to +20°C after applying the DC rated voltage for 500+24,-0 hours at +40±2°C, 90-95% RH. After the initial load test, the withstand voltage shall be tested by applying 250% of the DC rated voltage for 5 seconds. Appearance : no abnormality Capacitance change : ≤ ±20% of initial measured value Tan δ (DF) : ≤ 7% Insulation resistance : 50 Ω•F or 1,000MΩ, whichever is less
Load Life Test	The following specifications shall be satisfied when the capacitors are restored to +20°C after applying 200% of the DC rated voltage for 1,000+48,-0 hours at +85±2°C, or 1,000+48,-0 hours at +125±3°C with the initial DC rated voltage applied. After the initial load test, the withstand voltage shall be tested by applying 250% of the DC rated voltage for 5 seconds. Appearance : no abnormality Capacitance change : ≤ ±20% of initial measured value Tan δ (DF) : ≤ 7% Insulation resistance : 100 Ω•F or 1,000MΩ, whichever is less

Part Numbering System for THC Series

When ordering, always specify complete catalog number for THC Series.

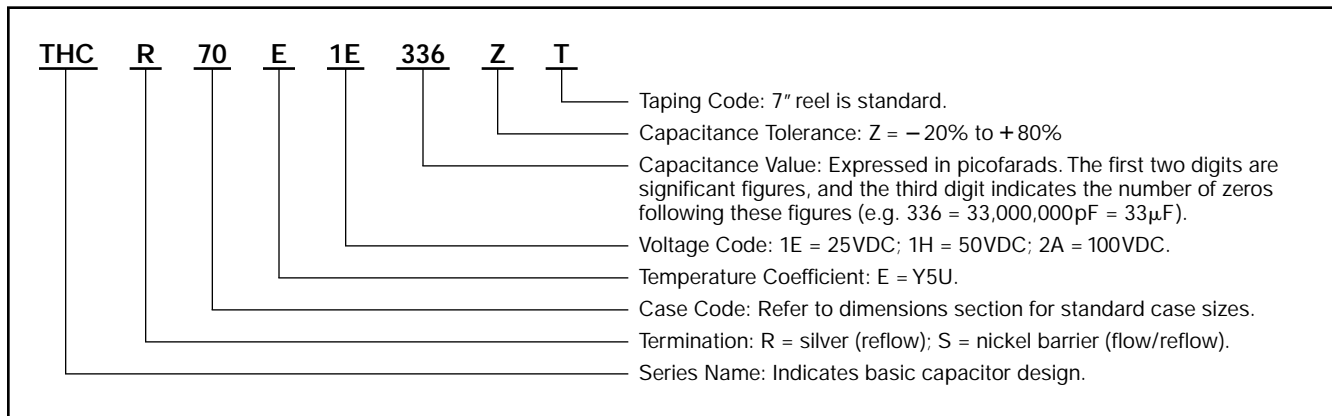

THC Series

Construction and Diagram of Dimensions

Multilayer Ceramic Chips

Unit: mm

THCR - Silver Termination

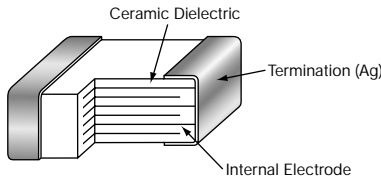

THCS - Nickel Barrier Termination

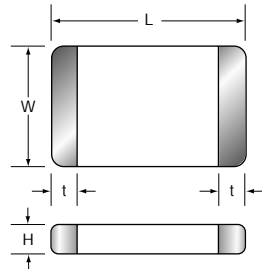
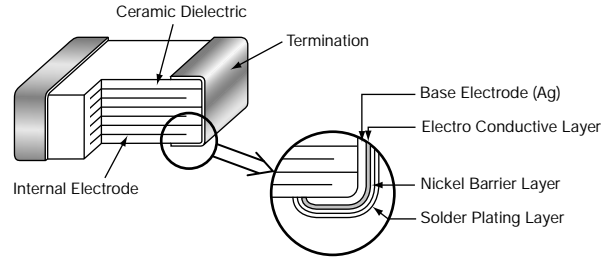

Case Dimensions

UCC Case Code	EIA Case Code	L	W	H max.	t
20	0805	2.0±0.2	1.25±0.2	1.25	0.3±0.2
30	1206	3.2±0.2	1.6±0.2	1.5	0.5±0.3
40	1210	3.2±0.2	2.5±0.2	1.8	0.6±0.3
50	1812	4.5±0.3	3.2±0.2	2.0	0.6±0.3
60	2220	5.7±0.4	5.0±0.4	2.2	0.8±0.5
70	3025	7.5±0.5	6.3±0.5	2.5	0.8±0.5

Standard Voltage Ratings - Multilayer Ceramic Chips

Rated Voltage (WVDC)	Capacitance (µF)	Catalog Part Number †	UCC Case Code*	EIA Case Code*	Maximum Ripple Current (A rms) at +125°C, 10kHz-1MHz
25 Volts	0.22	THCR20E1E224ZT	20	0805	0.2
	0.33	THCR20E1E334ZT	20	0805	0.2
	0.47	THCR20E1E474ZT	20	0805	0.2
	0.68	THCR20E1E684ZT	20	0805	0.2
	1.0	THCR30E1E105ZT	30	1206	0.3
	1.5	THCR30E1E155ZT	30	1206	0.3
	2.2	THCR30E1E225ZT	30	1206	0.3
	3.3	THCR40E1E335ZT	40	1210	0.5
	4.7	THCR40E1E475ZT	40	1210	0.5
	6.8	THCR50E1E685ZT	50	1812	1.0
	10	THCR50E1E106ZT	50	1812	1.0
	15	THCR60E1E156ZT	60	2220	1.5
22	THCR60E1E226ZT	60	2220	1.5	
33	THCR70E1E336ZT	70	3025	2.0	
50 Volts	0.1	THCR20E1H104ZT	20	0805	0.2
	0.15	THCR20E1H154ZT	20	0805	0.2
	0.22	THCR20E1H224ZT	20	0805	0.2
	0.33	THCR30E1H334ZT	30	1206	0.3
	0.47	THCR30E1H474ZT	30	1206	0.3
	0.68	THCR30E1H684ZT	30	1206	0.3
	1.0	THCR40E1H105ZT	40	1210	0.5
	1.5	THCR40E1H155ZT	40	1210	0.5
	2.2	THCR50E1H225ZT	50	1812	1.0
	3.3	THCR50E1H335ZT	50	1812	1.0
	4.7	THCR60E1H475ZT	60	2220	1.5
	6.8	THCR60E1H685ZT	60	2220	1.5
	10	THCR60E1H106ZT	60	2220	1.5
	15	THCR70E1H156ZT	70	3025	2.0
22	THCR70E1H226ZT	70	3025	2.0	

† R indicates silver termination. Substitute code letter S in part number for nickel barrier termination.

* Refer to diagram of dimensions for actual case sizes.

THC Series

Standard Voltage Ratings - Multilayer Ceramic Chips

Rated Voltage (WVDC)	Capacitance (μF)	Catalog Part Number †	UCC Case Code*	EIA Case Code*	Maximum Ripple Current (A rms) at +125°C, 10kHz-1MHz
100 Volts	0.047	THCR20E2A473ZT	20	0805	0.2
	0.068	THCR20E2A683ZT	20	0805	0.2
	0.1	THCR30E2A104ZT	30	1206	0.3
	0.15	THCR30E2A154ZT	30	1206	0.3
	0.22	THCR30E2A224ZT	30	1206	0.3
	0.33	THCR40E2A334ZT	40	1210	0.5
	0.47	THCR40E2A474ZT	40	1210	0.5
	0.68	THCR50E2A684ZT	50	1812	1.0
	1.0	THCR50E2A105ZT	50	1812	1.0
	1.5	THCR50E2A155ZT	50	1812	1.0
	2.2	THCR60E2A225ZT	60	2220	1.5
	3.3	THCR60E2A335ZT	60	2220	1.5
4.7	THCR70E2A475ZT	70	3025	2.0	

† R indicates silver termination. Substitute code letter S in part number for nickel barrier termination.

* Refer to diagram of dimensions for actual case sizes.

Soldering Guidelines

- To maintain good solderability, capacitors should be stored under the following conditions:
 - Avoid high temperature and high humidity. Storage temperature and humidity should not exceed +40°C, 70% RH.
 - Do not store in a chlorine or sulfur contaminated area.
 - Store capacitors with a desiccator after opening a package.
- Use Sn/Pb eutectic solder with Ag 2 to 5%.
- Use a rosin-based flux. Do not use a strong acid.

4. Due to the properties of ceramic, radical temperature changes or improper pre-heating before soldering may crack ceramic capacitors. Follow the recommended soldering conditions to avoid capacitor damage.

5. Minimize the soldering temperature and time to prevent the leaching of silver into the solder when using the reflow soldering method for the silver termination products.

6. Use isopropyl alcohol or trichloroethane cleaning solvent. For ultrasonic wave cleaning, the time should be 1 minute maximum.

Soldering Conditions

Recommended Soldering Land Design

Unit: mm

Soldering Land Dimensions

UCC Case Code	EIA Case Code	a	b	c	d
20	0805	1.0 - 1.4	3.0 - 4.6	0.9 - 1.2	0.3 - 0.6
30	1206	1.8 - 2.5	4.2 - 5.8	1.2 - 1.6	0.4 - 0.8
40	1210	1.8 - 2.5	4.2 - 5.8	1.8 - 2.5	0.5 - 1.0
50	1812	2.5 - 3.5	5.5 - 6.1	2.3 - 3.2	0.6 - 1.1
60	2220	2.7 - 4.7	6.7 - 8.3	3.5 - 5.0	0.7 - 1.2
70	3025	3.8 - 5.0	8.8 - 10.8	4.7 - 6.3	0.8 - 1.3

Recommended Soldering Temperature Profiles

Reflow Soldering Profile

Flow Soldering Profile

THC Series

Tape and Reel Specifications

Multilayer Ceramic Chips

Tape and Reel Specifications Conform to JIS-C-0806

Unit: mm

Taping

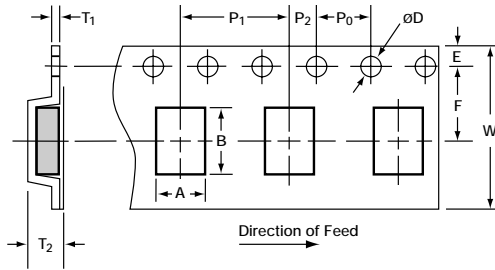

Taping Dimensions

UCC Case Code (EIA Case Code)	20 (0805)	30 (1206)	40 (1210)	50 (1812)	60 (2220)	70 (3025)
A ± 0.1	1.6	2.0	2.8	3.6	5.4	6.7
B ± 0.1	2.3	3.6	3.6	4.9	6.1	7.9
W ± 0.3	8.0	8.0	8.0	12.0	12.0	16.0
F ± 0.05	3.5	3.5	3.5	5.5	5.5	7.5
E ± 0.1	1.75	1.75	1.75	1.75	1.75	1.75
P1 ± 0.1	4.0	4.0	4.0	8.0	8.0	12.0
P2 ± 0.05	2.0	2.0	2.0	2.0	2.0	2.0
P0 ± 0.1	4.0	4.0	4.0	4.0	4.0	4.0
øD ± 0.1	1.5	1.5	1.5	1.5	1.5	1.5
T1 max.	0.6	0.6	0.6	0.6	0.6	0.6
T2 max.	1.5	1.5	2.5	2.5	2.5	3.0

Reel

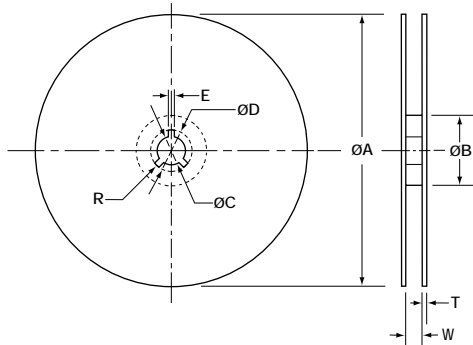

Reel Dimensions and Quantity Per Reel

UCC Case Code (EIA Case Code)	20 (0805)	30 (1206)	40 (1210)	50 (1812)	60 (2220)	70 (3025)
øA ± 2	178	178	178	178	178	178
øB min.	50	50	50	50	50	50
øC ± 0.5	13	13	13	13	13	13
øD ± 0.8	21	21	21	21	21	21
E ± 0.5	2	2	2	2	2	2
W ± 0.5	10	10	10	14	14	18
T ± 0.5	2	2	2	2	2	2
R	1.0	1.0	1.0	1.0	1.0	1.0
Pieces Per Reel*	3,000	3,000	1,600	800	800	500

*Specified quantity may vary for rating of capacitor.

Capacitance - Temperature Characteristics

Comparison Between THC (Y5U) and Typical Y5V

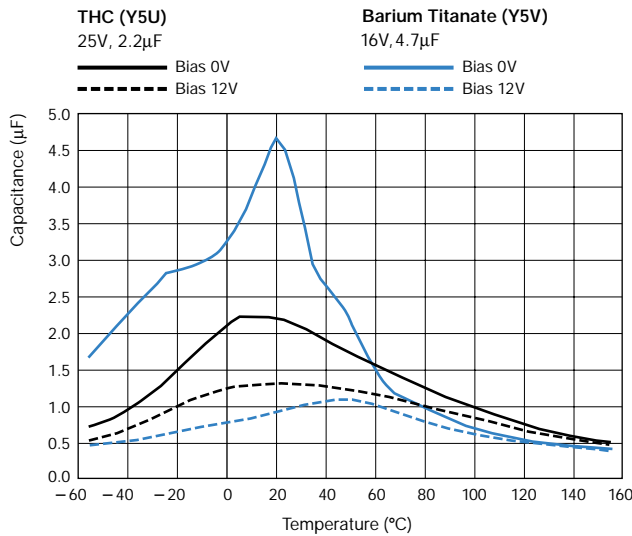

Comparison Between THC (Y5U) and Typical X7R

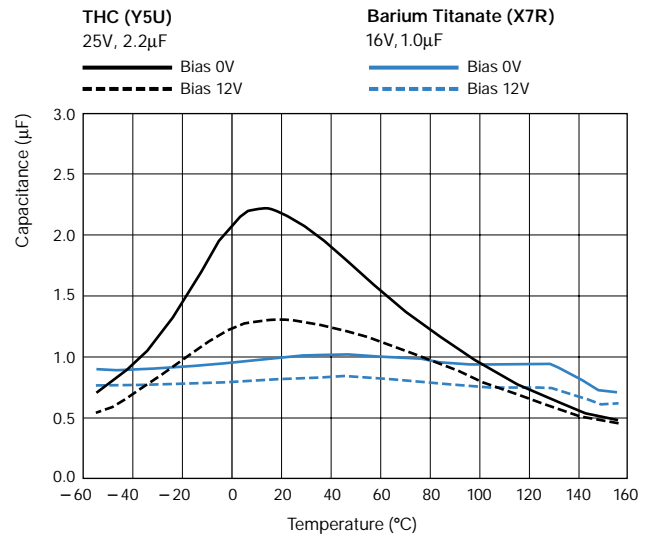

Temperature Characteristics

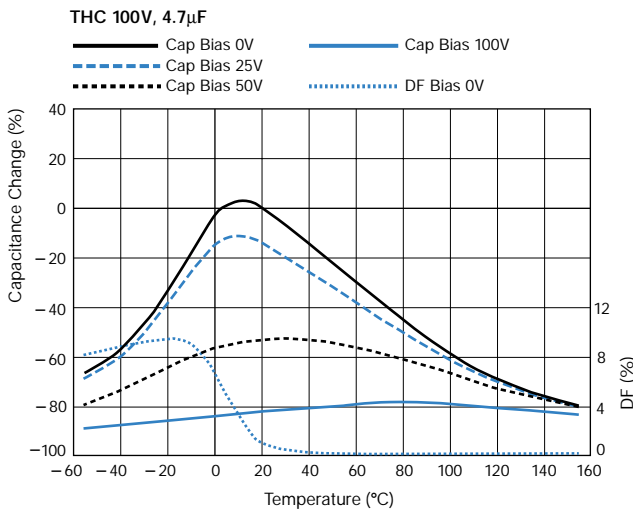
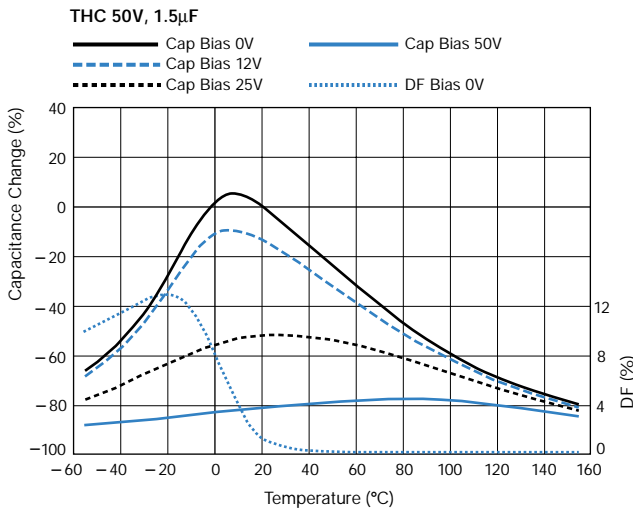
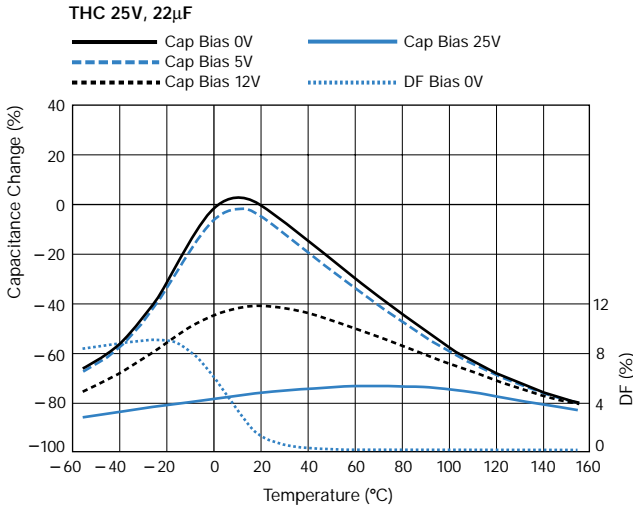

Impedance/ESR - Frequency Characteristics

