

Price* : 58.66 GBP



Main

Range of product	Harmony XAP
Product or component type	Die-cast empty control station
Device short name	XAPM
Product destination	For Ø 22 mm control and signalling units
Product front plate size	80 x 130 mm
Usable depth	49 mm
Number of cut-out	3 cut-outs
Colour of base of enclosure	Blue
Colour of cover	Blue
Material	Zinc alloy
Cable entry	1 hole with blanking plug for cable gland <= 14 mm 1 hole without blanking plug for cable gland <= 14 mm
Device mounting	Flush
IP degree of protection	IP69 conforming to NF C 20-010 IP65 conforming to IEC 60529 IP69K

Complementary

Number of vertical rows	1
Product weight	0.605 kg

Environment

Protective treatment	TC
Ambient air temperature for storage	-40...70 °C
Ambient air temperature for operation	-40...70 °C
Overvoltage category	Class I conforming to NF C 20-030 Class I conforming to IEC 60536

Contractual warranty

Warranty period	18 months
-----------------	-----------

Dimensions and Fixing

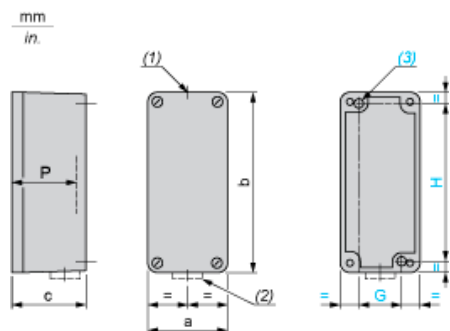

- (1) 1 hole, without blanking plug, for cable gland with 14 mm/0.55 in. maximum clamping capacity
- (2) 1 hole, with blanking plug (protrusion 6 mm/0.23 in.), for cable gland with 14 mm/0.55 in. maximum clamping capacity
- (3) 2 x Ø 5.6 mm/0.22 in. holes, depth 20 mm/0.78 in.
- P Usable depth

a		b		c		G		H		P	
mm	in.	mm	in.	mm	in.	mm	in.	mm	in.	mm	in.
80	3.15	130	5.12	51.5	2.03	50	1.97	115	4.53	49	1.93

Refer to the product characteristics to get the number of cut-outs.

Cut-out interaxis dimensions

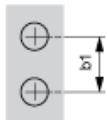

b1 Vertical interaxis: 30 mm/1.18 in.