

# Multilayer Ceramic Chip Capacitor

**Part Number:** 1206J1000822KXT

**Description:** 1206 100Vdc 8.2nF ±10% X7R (2R1) (CTI ≥ 600)

A range of X7R MLC capacitors to suit a variety of applications. In a wide selection of chip sizes, rated voltages and terminations, including FlexiCap™, the world's first commercially available flexible termination.

WS2, WR2, WS3 and WR3 parts use StackiCap™ patented construction technology.

DR1, WR2 and WR3 parts have a voltage de-rating above 105°C.

Suffix code PXX or PX mandates the use of precious metal electrode (PME) materials. This may incur additional costs.

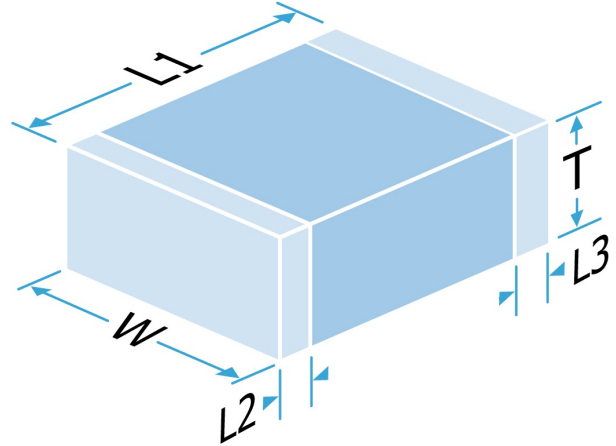

## Mechanical Specification

Size Code	1206
Length (L1) in mm (")	3.2 ± 0.20 (0.126 ± 0.008)
Width (W) in mm (")	1.6 ± 0.20 (0.063 ± 0.008)
Thickness (T) in mm (")	1.7 Max (0.068 Max)
Minimum Termination Band (L2,L3) in mm (")	0.25 (0.010)
Maximum Termination Band (L2,L3) in mm (")	0.75 (0.030)
Termination Material	Nickel Barrier, Sn Plated Solder (RoHS compliant)
Solderability	IEC-60068-2-58
Packaging	7" Reel Horizontal Orientation, 2500 per reel
Conformal Coating	Not normally required

## General Electrical Specification

Rated Voltage	100Vdc
Nominal Capacitance Value	8.2nF
Capacitance Tolerance	±10%
Tangent of Loss Angle (Tan δ)	≤0.025
Capacitance and Tan δ Test Conditions	1.0Vrms @ 1kHz
Voltage Proof	250Vdc
(Voltage applied for 5 secs max. @ 50mA max. charge current. 50% Max, RH)	
Min Insulation Resistance (IR)	100.00GOhm @ 100Vdc
Dielectric Classification	X7R (2R1) (CTI ≥ 600)
Rated Temperature Range	-55°C / +125°C
Maximum Capacitance Change over Temperature Range	No DC Voltage ±15%
Climatic Category (IEC)	Rated DC Voltage -
Ageing Characteristic	55/125/56
	<2% per decade (nominal capacitance is 1000 hour value)

### Knowles Precision Devices - Sales

Europe: KPD-Europe-sales@knowles.com

Asia: KPD-Asia-sales@knowles.com

USA: KPD-NA-sales@knowles.com

[www.knowlescapacitors.com](http://www.knowlescapacitors.com)

This datasheet is for a standard item and is confirmed valid on the date generated, the latest published data for this part may differ and is available at <http://www.knowlescapacitors.com> or by contacting us.

© The information contained on this drawing is confidential and may not be copied in whole or part in any form or disclosed to a third party without the consent of Knowles and any customer mentioned within this specification.

Data is correct to the best of our knowledge, errors and omissions excepted.

Date: Monday, January 12, 2026

20260112 094337458UTC

# Multilayer Ceramic Chip Capacitor

**Part Number:** 1206J1000822KXT

**Description:** 1206 100Vdc 8.2nF ±10% X7R (2R1) (CTI ≥ 600)

## Environmental

RoHS Compliant to 2011/65/EC as amended by 2015/863/EU	Compliant
REACH Compliant	250 compliant
California Proposition 65	No exposure risk

## Board Layout

Knowles' conventional 2-terminal chip capacitors can generally be mounted using pad designs in accordance with international specification IPC-7351, Generic Requirements for Surface Mount Design and Land Pattern Standards, but there are some other factors that have been shown to reduce mechanical stress, such as reducing the pad width to less than the chip width. In addition, the position of the chip on the board should be considered.

### IPC-7351 pad design

	1206	
C	3.00mm	0.118"
Y	1.15mm	0.045"
X	1.80mm	0.071"

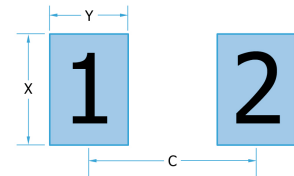

Some high voltage parts may require modifications to the board layout and/or the addition of a conformal coating to prevent flashover, especially under high humidity conditions. Board cleanliness and environmental conditions can also impact this. Refer to application note AN0043 for further information.

## Packaging

Tape packaging information for tape-and-reel parts:

Tape and reel packing of surface mounting chip capacitors for automatic placement are in accordance with IEC60286-3.

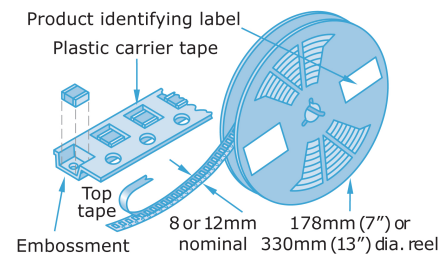

## Soldering

Reflow solder in accordance with IPC-A-610. Recommended reflow profile as laid down in IPC/JEDEC J-STD-020.

Wave soldering is also possible, but care must be taken for case sizes 1210 and larger and component thickness >1.0mm. Trials are encouraged.

Hand soldering is not recommended and can lead to component damage through thermal shock.

PdAg terminations are primarily intended for conductive epoxy attachment - they may be suitable for soldering but trials are recommended.

Application notes with mounting and handling guidance are available on request.



Compex

DLI

Johanson MFG

Novacap

Syfer

Voltronics

### Knowles Precision Devices - Sales

Europe: KPD-Europe-sales@knowles.com

Asia: KPD-Asia-sales@knowles.com

USA: KPD-NA-sales@knowles.com

[www.knowlescapacitors.com](http://www.knowlescapacitors.com)

This datasheet is for a standard item and is confirmed valid on the date generated, the latest published data for this part may differ and is available at <http://www.knowlescapacitors.com> or by contacting us.

© The information contained on this drawing is confidential and may not be copied in whole or part in any form or disclosed to a third party without the consent of Knowles and any customer mentioned within this specification.

Data is correct to the best of our knowledge, errors and omissions excepted.

Date: Monday, January 12, 2026

20260112 09433745UTC

**Part Number:** 1206J1000822KXT

**Description:** 1206 100Vdc 8.2nF ±10% X7R (2R1) (CTI ≥ 600)

## DC Bias Characteristics

VCC Characterization

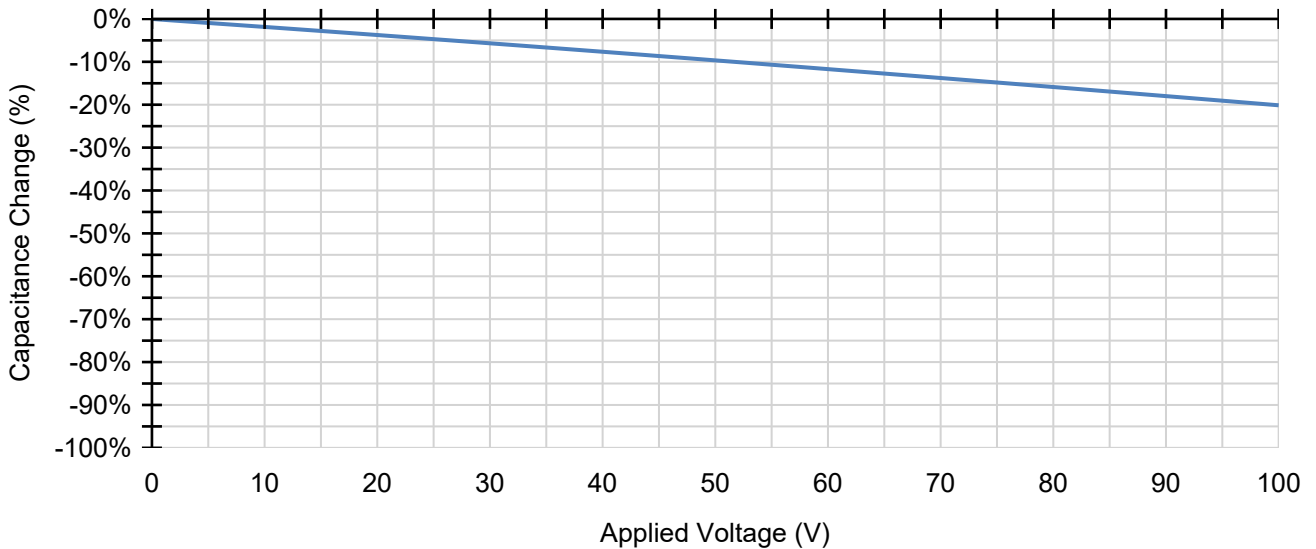

% Capacitance Drift with Time

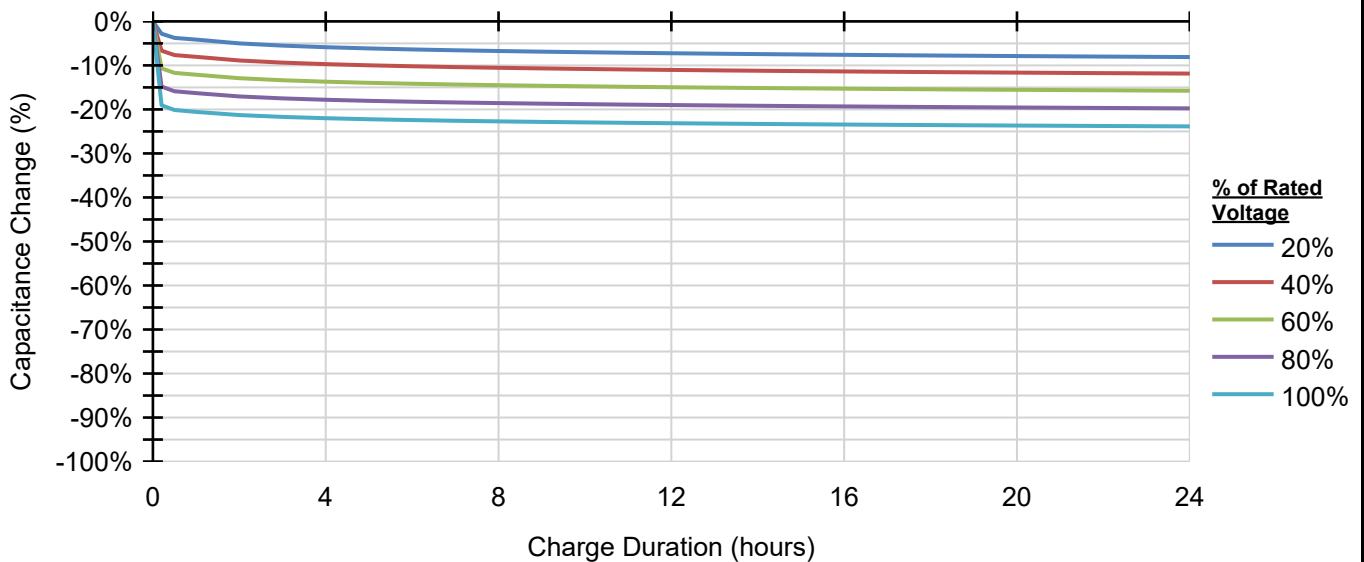

The curves represent the 'typical worst case' curve – i.e. the typical curve of a 'worst case' component having the most capacitance loss delivered against the specification.

Knowles Precision Devices reserve the right to substitute any component with a similar component of the same or higher specification. In some cases this may mean that the capacitance drop with applied voltage is, in practice, less than the curve shown

Compex

DLI

Johanson MFG

Novacap

Syfer

Voltronics

### Knowles Precision Devices - Sales

Europe: KPD-Europe-sales@knowles.com

Asia: KPD-Asia-sales@knowles.com

USA: KPD-NA-sales@knowles.com

[www.knowlescapacitors.com](http://www.knowlescapacitors.com)

This datasheet is for a standard item and is confirmed valid on the date generated, the latest published data for this part may differ and is available at <http://www.knowlescapacitors.com> or by contacting us.

© The information contained on this drawing is confidential and may not be copied in whole or part in any form or disclosed to a third party without the consent of Knowles and any customer mentioned within this specification.

Data is correct to the best of our knowledge, errors and omissions excepted.

Date: Monday, January 12, 2026

20260112 094337458UTC

**Part Number:** 1206J1000822KXT

**Description:** 1206 100Vdc 8.2nF ±10% X7R (2R1) (CTI ≥ 600)

### Typical Capacitance Change vs Temperature

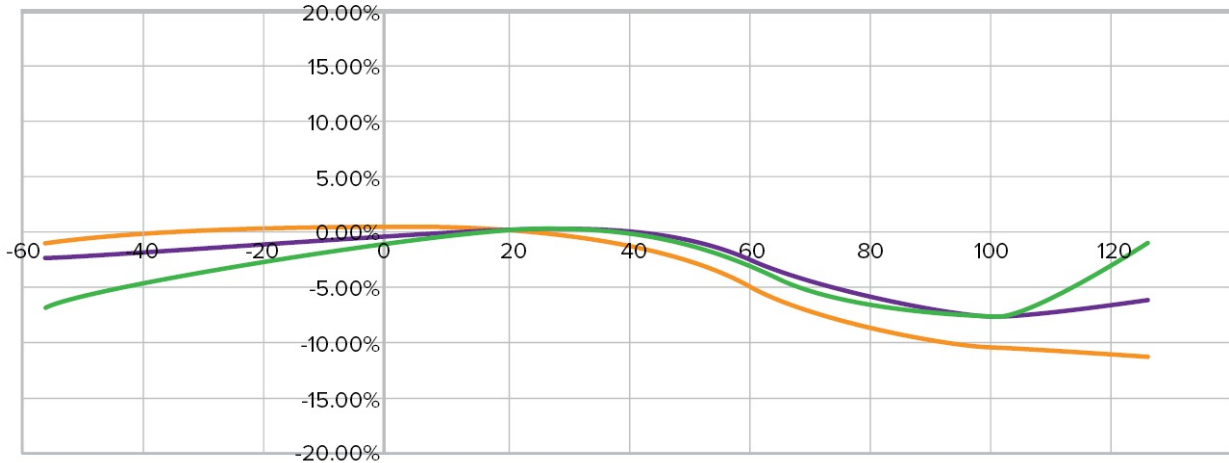

Typical TC Curves for X7R capacitors showing different dielectric types

#### Stable X7R Dielectric

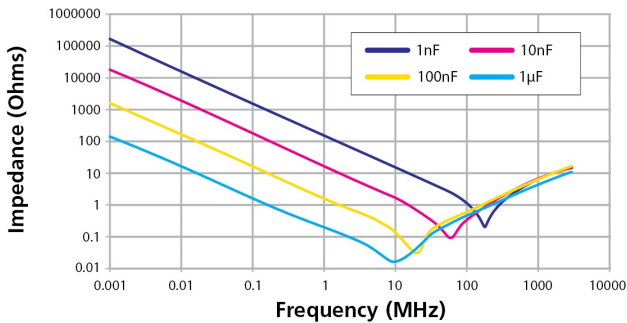

#### Stable X7R Dielectric

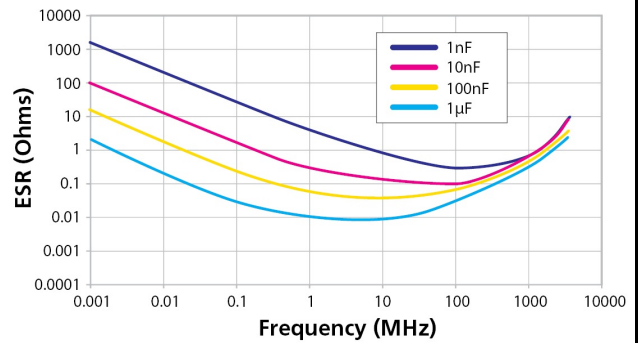

#### Stable X7R Dielectric — 10nF



Typical Performance Data - X7R

For part specific data, please contact your local sales office  
 This data is for reference only and does not constitute a specification.

Compex

DLI

Johanson MFG

Novacap

Syfer

Voltronics

#### Knowles Precision Devices - Sales

Europe: KPD-Europe-sales@knowles.com

Asia: KPD-Asia-sales@knowles.com

USA: KPD-NA-sales@knowles.com

[www.knowlescapacitors.com](http://www.knowlescapacitors.com)

This datasheet is for a standard item and is confirmed valid on the date generated, the latest published data for this part may differ and is available at <http://www.knowlescapacitors.com> or by contacting us.

© The information contained on this drawing is confidential and may not be copied in whole or part in any form or disclosed to a third party without the consent of Knowles and any customer mentioned within this specification.

Data is correct to the best of our knowledge, errors and omissions excepted.

Date: Monday, January 12, 2026

20260112 094337458UTC