

ISL8117ADEMO3Z

User's Manual: Demonstration Board

Industrial Analog and Power

ISL8117ADEMO3Z

Demonstration Board

UG134
Rev.0.00
Aug 3, 2017

1. Overview

The ISL8117ADEMO3Z demonstration board (shown in [Figure 4](#)) features the [ISL8117A](#). The ISL8117A is a 60V high voltage synchronous buck controller that offers external soft-start, independent enable functions, and integrates UV/OV/OC/OT protection. Its current mode control architecture keeps peripheral component count minimal. Programmable switching frequency ranging from 100kHz to 2MHz helps to optimize inductor size while the strong gate driver delivers up to 30A for the buck output.

1.1 Key Features

- Small, compact design
- Wide input range: 6V to 60V
- High light-load efficiency in pulse skipping DEM operation
- Programmable soft-start
- Optional DEM/CCM operation
- Supports prebias output with SR soft-start
- External frequency sync
- PGOOD indicator
- OCP, OVP, OTP, and UVP protection

1.2 Specifications

The ISL8117ADEMO3Z demonstration board is designed for high current applications. The current rating of the ISL8117ADEMO3Z is limited by the FETs and inductor selected. The electrical ratings of the ISL8117ADEMO3Z are shown in [Table 1](#).

Table 1. Electrical Ratings

Parameter	Rating
Input Voltage	6V to 60V
Switching Frequency	300kHz
Output Voltage	5V
Output Current	6A
OCP Set Point	Minimum 8A at ambient room temperature

1.3 Ordering Information

Part Number	Description
ISL8117ADEMO3Z	High voltage PWM step-down synchronous buck controller

1.4 Related Literature

- For a full list of related documents, visit our website
 - [ISL8117A](#) product page

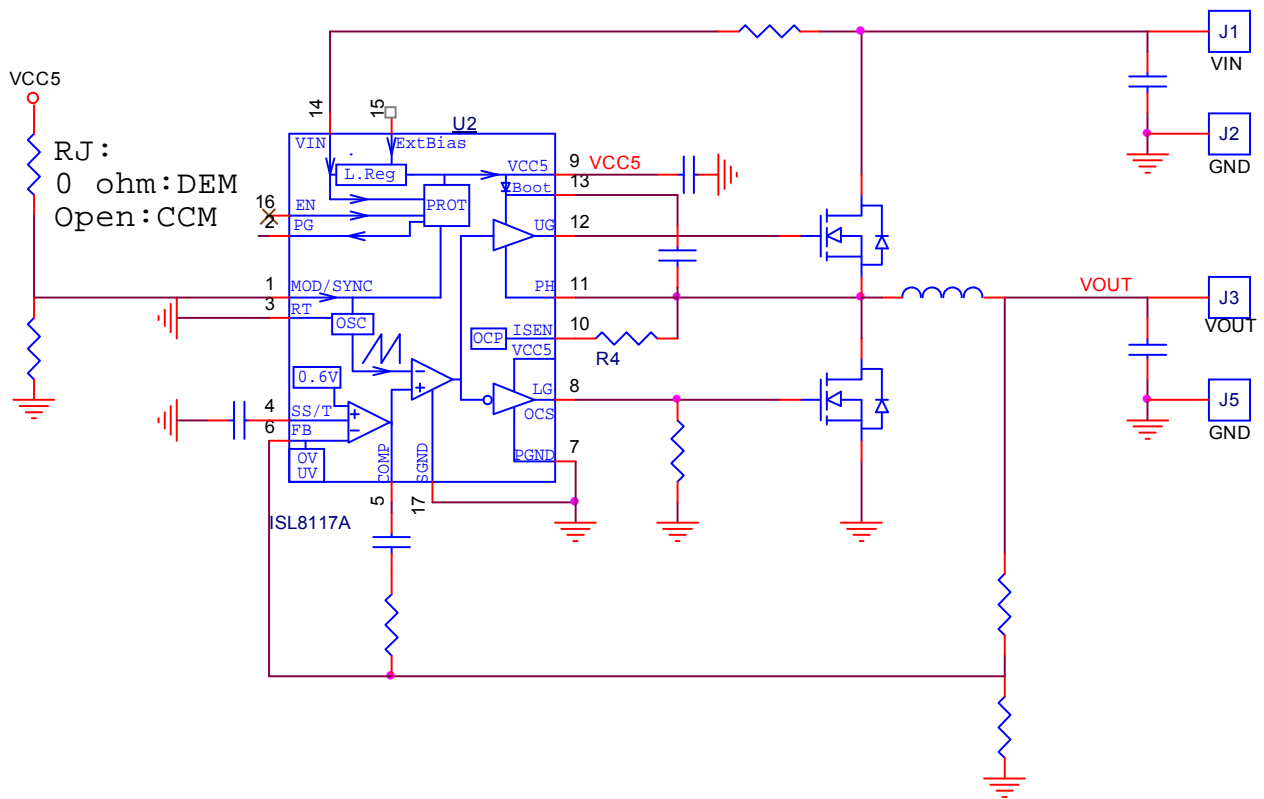

Figure 1. ISL8117ADEMO3Z Block Diagram

2. Functional Description

The ISL8117ADEMO3Z is a compact design with high efficiency and high power density.

As shown in [Figure 3 on page 7](#), 6V to 60V V_{IN} is supplied to J1 (+) and J2 (-). The regulated 5V output on J3 (+) and J5 (-) can supply up to 6A to the load.

2.1 Recommended Testing Equipment

The following materials are recommended to perform testing:

- 0V to 60V power supply with at least 10A source current capability
- Electronic loads capable of sinking current up to 10A
- Digital Multimeters (DMMs)
- 100MHz quad-trace oscilloscope

2.2 Quick Test Guide

- (1) Ensure that the circuit is correctly connected to the supply and electronic loads prior to applying any power. Refer to [Figure 3](#) for proper setup.
- (2) Turn on the power supply.
- (3) Adjust the input voltage, V_{IN} , within the specified range and observe output voltage. The output voltage variation should be within 3%.
- (4) Adjust load current within the specified range and observe output voltage. The output voltage variation should be within 3%.
- (5) Use an oscilloscope to observe output voltage ripple and phase node ringing. For accurate measurement, refer to [Figure 2](#) for proper test setup.

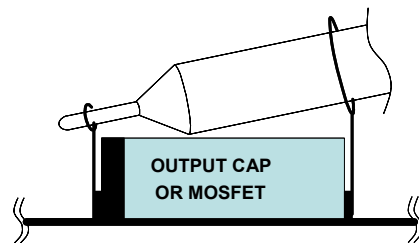

Figure 2. Proper Probe Setup to Measure Output Ripple and Phase Node Ringing

2.3 Operating Range

The input voltage range is from 6V to 60V for an output voltage of 5V. The rated load current is 6A with the OCP point set at minimum 8A at room temperature ambient conditions.

The operating temperature range of ISL8117A is -40°C to +125°C. Please note that airflow is needed.

2.3.1 Evaluating the Other Output Voltages

The ISL8117ADEMO3Z demonstration board output is preset to 5V, however, the output can be adjusted from 1.8V to 5V. The output voltage programming resistor, R_2 , will depend on the desired output voltage of the regulator and the value of the feedback resistor R_1 , as shown in [Equation 1](#).

$$R_2 = R_1 \left(\frac{0.6}{V_{OUT} - 0.6} \right) \quad (\text{EQ. 1})$$

[Table 2](#) shows the component selection that should be used for the respective V_{OUT} of 1.8V, 3.3V, and 5V.

Table 2. External Component Selection

V_{OUT} (V)	R_2 (k Ω)
1.8	24.9
3.3	11
5	6.8

Notes:

1. If $V_{OUT} < 3.3V$, the minimal V_{IN} is about 4.5V for full load. If $V_{OUT} = 5V$, the minimal V_{IN} is about 6V for full load.
2. Unless $V_{OUT} = 5V$, R11 should be removed.

3. PCB Layout Guidelines

Careful attention to layout requirements is necessary for successful implementation of an ISL8117A based DC/DC converter. The ISL8117A switches at a very high frequency and therefore the switching times are very short. At these switching frequencies, even the shortest trace has significant impedance. Also, the peak gate drive current rises significantly in an extremely short time. Transition speed of the current from one device to another causes voltage spikes across the interconnecting impedances and parasitic circuit elements. These voltage spikes can degrade efficiency, generate EMI, and increase device overvoltage stress and ringing. Careful component selection and proper PC board layout minimizes the magnitude of these voltage spikes.

There are three sets of critical components in a DC/DC converter using the ISL8117A:

- The controller
- The switching power components
- The small signal components

The switching power components are the most critical from a layout point of view because they switch a large amount of energy, which tends to generate a large amount of noise. The critical small signal components are those connected to sensitive nodes or those supplying critical bias currents. A multilayer printed circuit board is recommended.

3.1 Layout Considerations

- (1) The input capacitors, upper FET, lower FET, inductor, and output capacitor should be placed first. Isolate these power components on dedicated areas of the board with their ground terminals adjacent to one another. Place the input high frequency decoupling ceramic capacitors very close to the MOSFETs.
- (2) If signal components and the IC are placed in a separate area to the power train, it is recommended to use full ground planes in the internal layers with shared SGND and PGND to simplify the layout design. Otherwise, use separate ground planes for power ground and small signal ground. Connect the SGND and PGND together close to the IC. DO NOT connect them together anywhere else.
- (3) The loop formed by the input capacitor, the top FET, and the bottom FET must be kept as small as possible.
- (4) Ensure the current paths from the input capacitor to the MOSFET, to the output inductor and the output capacitor are as short as possible with maximum allowable trace widths.
- (5) Place the PWM controller IC close to the lower FET. The LGATE connection should be short and wide. The IC can be best placed over a quiet ground area. Avoid switching ground loop currents in this area.
- (6) Place a VCC5V bypass capacitor very close to the VCC5V pin of the IC and connect its ground to the PGND plane.
- (7) Place the gate drive components (optional BOOT diode and BOOT capacitors) together near the controller IC.
- (8) The output capacitors should be placed as close to the load as possible. Use short wide copper regions to connect the output capacitors to load to avoid inductance and resistances.
- (9) Use copper filled polygons or wide but short trace to connect the junction of the upper FET, lower FET, and output inductor. Also keep the PHASE node connection to the IC short. DO NOT unnecessarily oversize the copper islands for the PHASE node. Since the phase nodes are subjected to very high dv/dt voltages, the stray capacitor formed between these islands and the surrounding circuitry will tend to couple switching noise.
- (10) Route all high-speed switching nodes away from the control circuitry.
- (11) Create a separate small analog ground plane near the IC. Connect the SGND pin to this plane. All small signal grounding paths including feedback resistors, current limit setting resistor, soft-starting capacitor, and EN pull-down resistor should be connected to this SGND plane.
- (12) Separate the current sensing trace from the PHASE node connection.
- (13) Ensure the feedback connection to the output capacitor is short and direct.

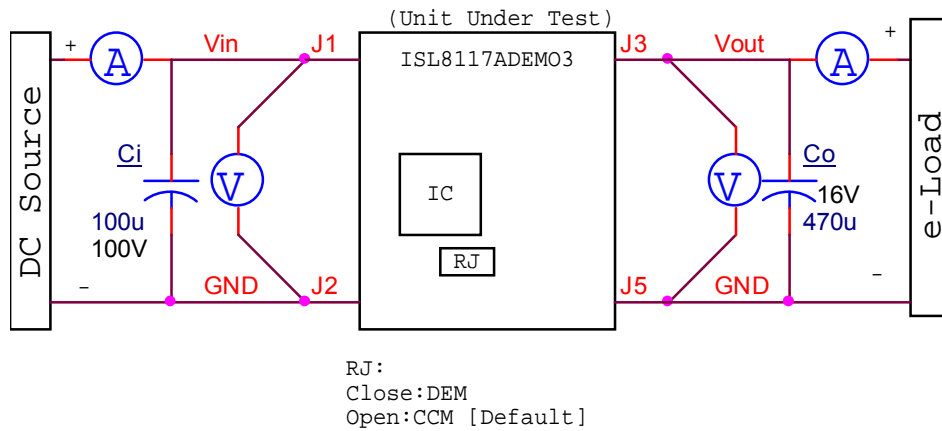

Figure 3. Proper Test Setup

3.2 ISL8117ADEMO3Z Demonstration Board



Figure 4. ISL8117ADEMO3Z Top Side



Figure 5. ISL8117ADEMO3Z Bottom Side

3.3 Schematic

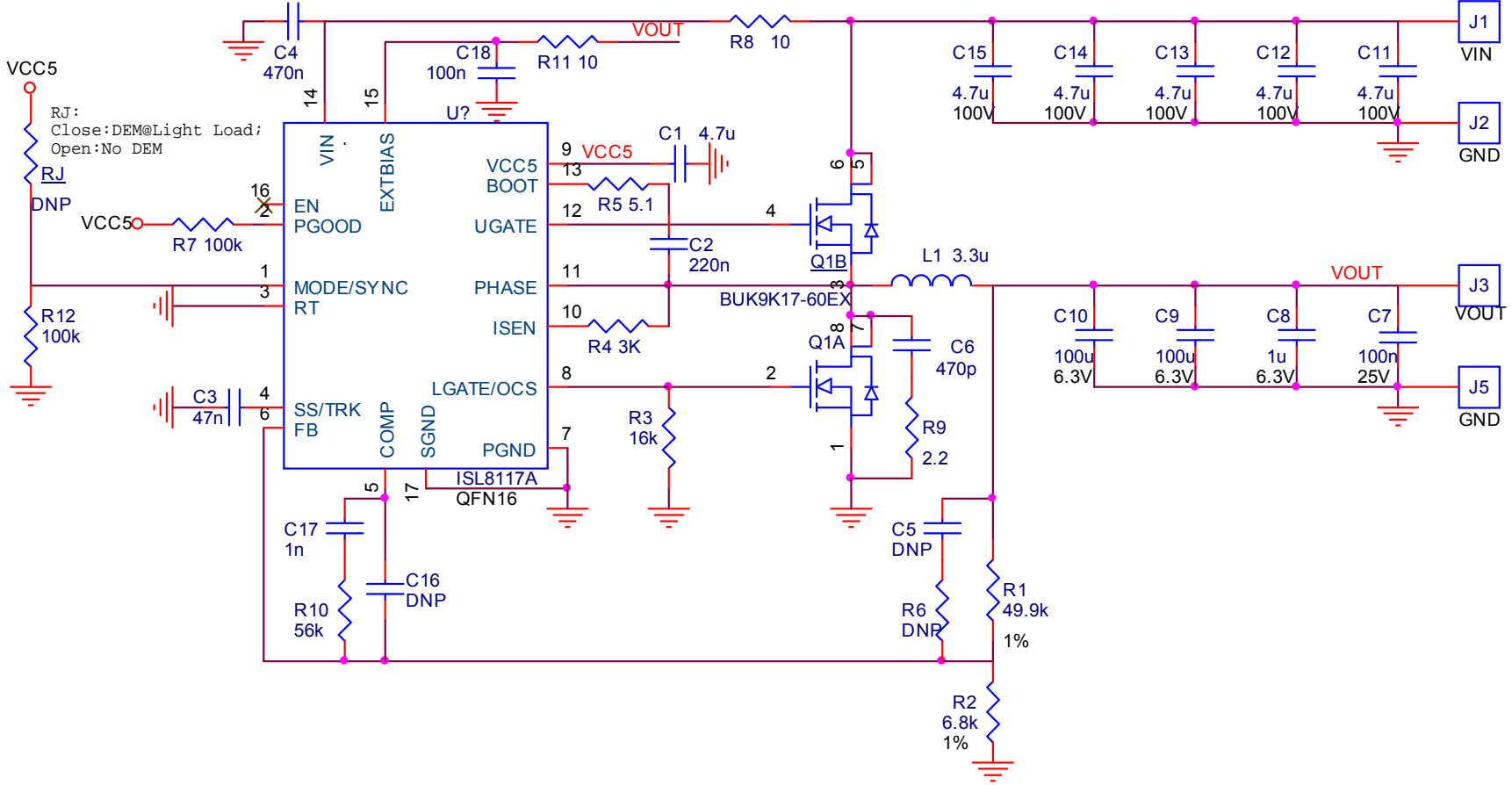

Figure 6. ISL8117A DEMO3Z Schematic

3.4 ISL8117ADEMO3Z Bill of Materials

Qty	Reference Designator	Description	Manufacturer	Manufacturer Part
1	C17	CAP, SMD, 0603, 1000pF, 50V, 10%, X7R, RoHS	AVX	06035C102KAT2A
1	C7	CAP, SMD, 0603, 0.1μF, 25V, 10%, X7R, ROHS	Murata	GRM188R71E104KA01D
1	C8	CAP, SMD, 0603, 1μF, 6.3V, 10%, X5R, ROHS	Panasonic	ECJ1VB0J105K
1	C2	CAP, SMD, 0603, 0.22μF, 25V, 10%, X7R, ROHS	TDK	C1608X7R1E224K
1	C6	CAP, SMD, 0603, 470pF, 100V, 10%, X7R, ROHS	Vishay	VJ0603Y471KXBA
1	C3	CAP, SMD, 0603, 0.047μF, 25V, 10%, X7R, ROHS	Murata	GRM188R71E473KA01D
1	C1	CAP, SMD, 0603, 4.7μF, 10V, 10%, X5R, ROHS	Venkel	CR0603-16W-4701FT
0	C5, C16	CAP, SMD, 0603, DNP-Place Holder, ROHS		
1	C18	CAP, SMD, 0805, 0.1μF, 100V, 10%, X7R, ROHS	TDK	C2012X7R2A104K
1	C4	CAP, SMD, 0805, 0.47μF, 100V, 10%, X7R, ROHS	Murata	GRM21BR72A474KA73L
2	C9, C10	CAP, SMD, 1210, 100μF, 6.3V, 10%, X5R, ROHS	AVX	12106D107KAT2A
5	C11, C12, C13, C14, C15	CAP, SMD, 1210, 4.7μF, 100V, 10%, X7S, ROHS	TDK	CGA6M3X7S2A475K200AB
1	L1	COIL-PWR INDUCTOR, SMD, 8.4x7.9, 3.3μH, 20%, 14A, ROHS	Würth Electronics	7443340330
1	J1, J2, J3, J5	CONN-TURRET, TERMINAL POST, TH, ROHS	Keystone	1514-2
1	U2	IC-55V SWITCHING CONTROLLER, 16P, QFN, ROHS	Intersil	ISL8117AFRZ
1	Q1	TRANSIST-MOS, DUAL N-CHANNEL, SMD, 8P, 56LFAK, 60V, 26A, ROHS	NXP Semiconductor	BUK9K17-60EX
2	R8, R11	RES, SMD, 0603, 10Ω, 1/10W, 1%, TF, ROHS	KOA	RK73H1JT10R0F
1	R9	RES, SMD, 0603, 2.2Ω, 1/10W, 1%, TF, ROHS	Panasonic	ERJ-3RQF2R2V
1	R5	RES, SMD, 0603, 5.1Ω, 1/10W, 1%, TF, ROHS	Venkel	CR0603-10W-05R1FT
2	R7, R12	RES, SMD, 0603, 100k, 1/10W, 1%, TF, ROHS	Venkel	CR0603-10W-1003FT
1	R3	RES, SMD, 0603, 16k, 1/10W, 1%, TF, ROHS	Venkel	CR0603-16W-1602FT
1	R4	RES, SMD, 0603, 3k, 1/10W, 1%, TF, ROHS	Yageo	RC0603FR-073KL
1	R1	RES, SMD, 0603, 49.9k, 1/10W, 1%, TF, ROHS	Venkel	CR0603-10W-4992FT
1	R10	RES, SMD, 0603, 56k, 1/10W, 1%, TF, ROHS	Panasonic	ERJ-3EKF5602V
1	R2	RES, SMD, 0603, 6.8k, 1/10W, 1%, TF, ROHS	Yageo	RC0603FR-076K8L
0	R6, RJ	RES, SMD, 0603, DNP-Place Holder, ROHS		

3.5 ISL8117ADEMO3Z PCB Layout

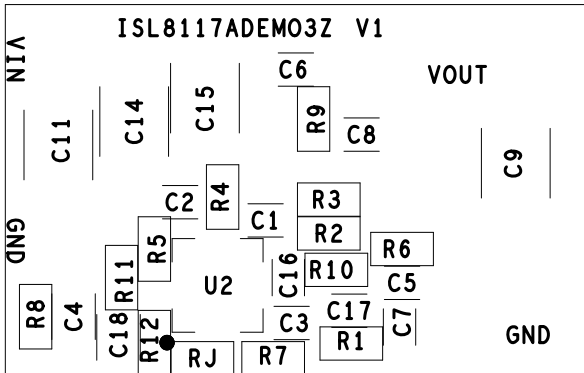

Figure 7. Assembly Top

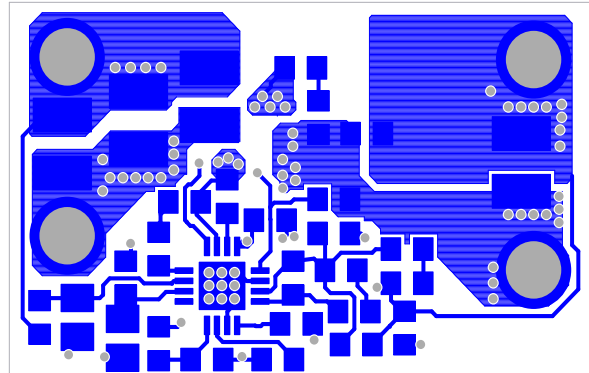

Figure 8. Top Layer

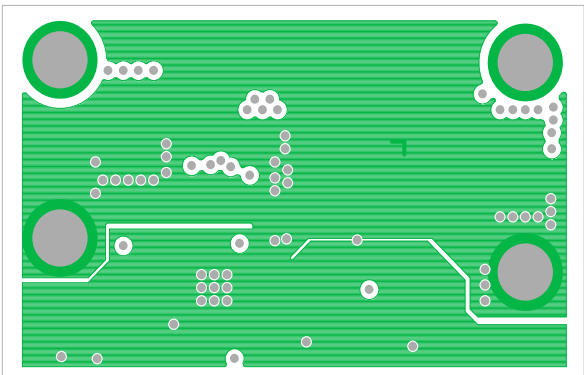

Figure 9. Second Layer (Solid Ground)

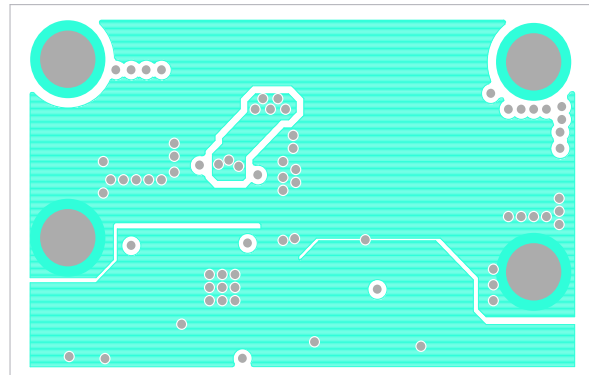

Figure 10. Third Layer

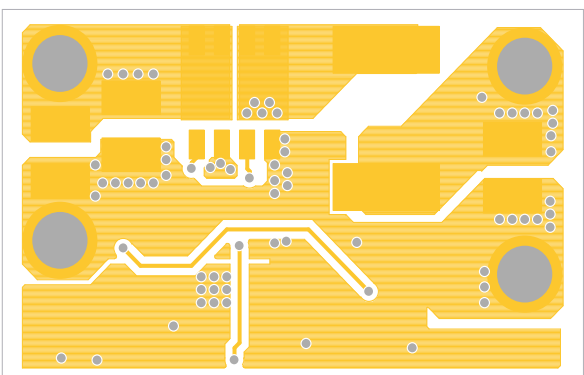

Figure 11. Bottom Layer

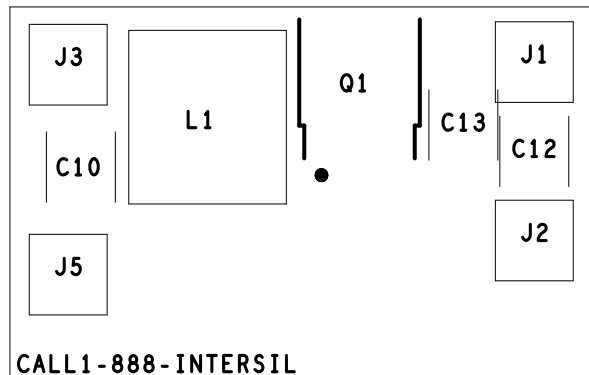

Figure 12. Assembly Bottom

3.6 Typical Demonstration Board Performance Curves

$V_{IN} = 24V$, $V_{OUT} = 5V$, unless otherwise noted.

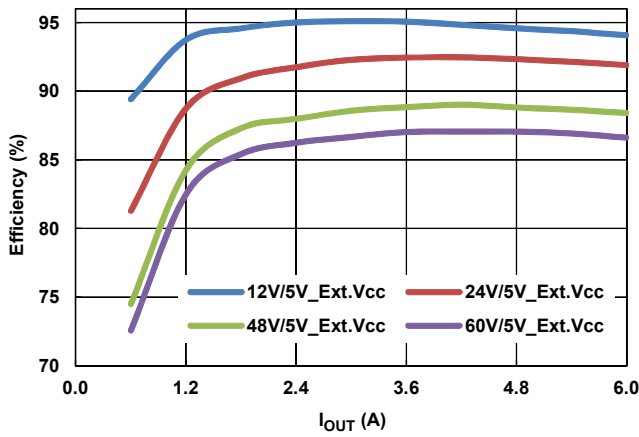

Figure 13. CCM Efficiency

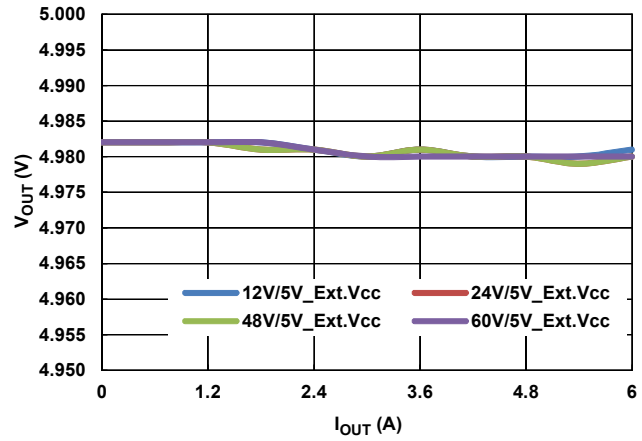

Figure 14. CCM Load Regulation

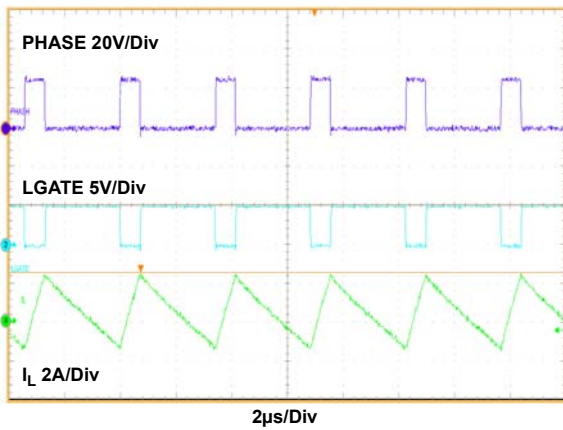

Figure 15. PHASE, LGATE, and Inductor Current Waveforms, $I_0 = 0A$

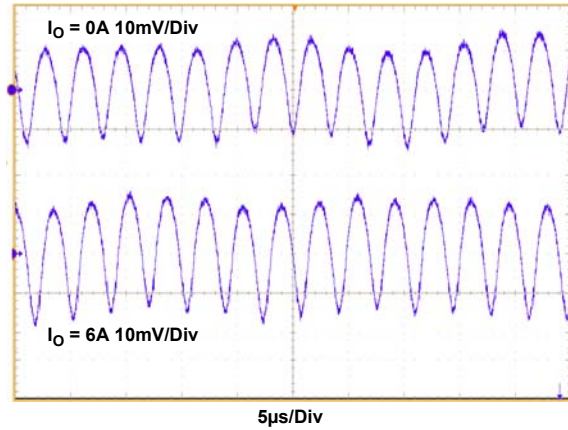

Figure 16. Output Ripple, Mode = CCM

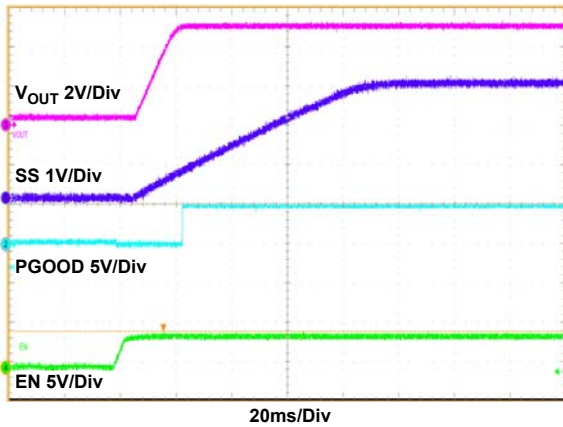

Figure 17. CCM Start-Up Waveforms: V_{OUT} , SS, PGOOD, EN, $I_0 = 0A$

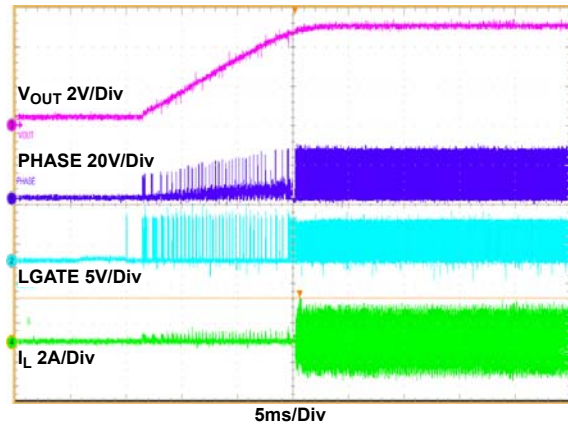

Figure 18. CCM Start-Up Waveforms: V_{OUT} , PHASE, LGATE, I_L , $I_0 = 0A$

$V_{IN} = 24V$, $V_{OUT} = 5V$, unless otherwise noted. (Continued)

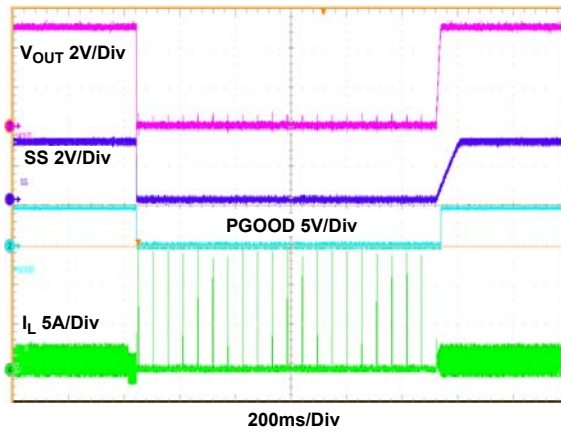

Figure 19. Short-Circuit Waveforms

4. Revision History

Rev.	Date	Description
0.00	Aug 3, 2017	Initial release

Notice

1. Descriptions of circuits, software and other related information in this document are provided only to illustrate the operation of semiconductor products and application examples. You are fully responsible for the incorporation or any other use of the circuits, software, and information in the design of your product or system. Renesas Electronics disclaims any and all liability for any losses and damages incurred by you or third parties arising from the use of these circuits, software, or information.
2. Renesas Electronics hereby expressly disclaims any warranties against and liability for infringement or any other claims involving patents, copyrights, or other intellectual property rights of third parties, by or arising from the use of Renesas Electronics products or technical information described in this document, including but not limited to, the product data, drawings, charts, programs, algorithms, and application examples.
3. No license, express, implied or otherwise, is granted hereby under any patents, copyrights or other intellectual property rights of Renesas Electronics or others.
4. You shall not alter, modify, copy, or reverse engineer any Renesas Electronics product, whether in whole or in part. Renesas Electronics disclaims any and all liability for any losses or damages incurred by you or third parties arising from such alteration, modification, copying or reverse engineering.
5. Renesas Electronics products are classified according to the following two quality grades: "Standard" and "High Quality". The intended applications for each Renesas Electronics product depends on the product's quality grade, as indicated below.
"Standard": Computers; office equipment; communications equipment; test and measurement equipment; audio and visual equipment; home electronic appliances; machine tools; personal electronic equipment; industrial robots; etc.
"High Quality": Transportation equipment (automobiles, trains, ships, etc.); traffic control (traffic lights); large-scale communication equipment; key financial terminal systems; safety control equipment; etc.
Unless expressly designated as a high reliability product or a product for harsh environments in a Renesas Electronics data sheet or other Renesas Electronics document, Renesas Electronics products are not intended or authorized for use in products or systems that may pose a direct threat to human life or bodily injury (artificial life support devices or systems; surgical implantations; etc.), or may cause serious property damage (space system; undersea repeaters; nuclear power control systems; aircraft control systems; key plant systems; military equipment; etc.). Renesas Electronics disclaims any and all liability for any damages or losses incurred by you or any third parties arising from the use of any Renesas Electronics product that is inconsistent with any Renesas Electronics data sheet, user's manual or other Renesas Electronics document.
6. When using Renesas Electronics products, refer to the latest product information (data sheets, user's manuals, application notes, "General Notes for Handling and Using Semiconductor Devices" in the reliability handbook, etc.), and ensure that usage conditions are within the ranges specified by Renesas Electronics with respect to maximum ratings, operating power supply voltage range, heat dissipation characteristics, installation, etc. Renesas Electronics disclaims any and all liability for any malfunctions, failure or accident arising out of the use of Renesas Electronics products outside of such specified ranges.
7. Although Renesas Electronics endeavors to improve the quality and reliability of Renesas Electronics products, semiconductor products have specific characteristics, such as the occurrence of failure at a certain rate and malfunctions under certain use conditions. Unless designated as a high reliability product or a product for harsh environments in a Renesas Electronics data sheet or other Renesas Electronics document, Renesas Electronics products are not subject to radiation resistance design. You are responsible for implementing safety measures to guard against the possibility of bodily injury, injury or damage caused by fire, and/or danger to the public in the event of a failure or malfunction of Renesas Electronics products, such as safety design for hardware and software, including but not limited to redundancy, fire control and malfunction prevention, appropriate treatment for aging degradation or any other appropriate measures. Because the evaluation of microcomputer software alone is very difficult and impractical, you are responsible for evaluating the safety of the final products or systems manufactured by you.
8. Please contact a Renesas Electronics sales office for details as to environmental matters such as the environmental compatibility of each Renesas Electronics product. You are responsible for carefully and sufficiently investigating applicable laws and regulations that regulate the inclusion or use of controlled substances, including without limitation, the EU RoHS Directive, and using Renesas Electronics products in compliance with all these applicable laws and regulations. Renesas Electronics disclaims any and all liability for damages or losses occurring as a result of your noncompliance with applicable laws and regulations.
9. Renesas Electronics products and technologies shall not be used for or incorporated into any products or systems whose manufacture, use, or sale is prohibited under any applicable domestic or foreign laws or regulations. You shall comply with any applicable export control laws and regulations promulgated and administered by the governments of any countries asserting jurisdiction over the parties or transactions.
10. It is the responsibility of the buyer or distributor of Renesas Electronics products, or any other party who distributes, disposes of, or otherwise sells or transfers the product to a third party, to notify such third party in advance of the contents and conditions set forth in this document.
11. This document shall not be reprinted, reproduced or duplicated in any form, in whole or in part, without prior written consent of Renesas Electronics.
12. Please contact a Renesas Electronics sales office if you have any questions regarding the information contained in this document or Renesas Electronics products.
(Note 1) "Renesas Electronics" as used in this document means Renesas Electronics Corporation and also includes its directly or indirectly controlled subsidiaries.
(Note 2) "Renesas Electronics product(s)" means any product developed or manufactured by or for Renesas Electronics.

(Rev.4.0-1 November 2017)



SALES OFFICES

Renesas Electronics Corporation

<http://www.renesas.com>

Refer to "<http://www.renesas.com/>" for the latest and detailed information.

Renesas Electronics America Inc.

1001 Murphy Ranch Road, Milpitas, CA 95035, U.S.A.
Tel: +1-408-432-8888, Fax: +1-408-434-5351

Renesas Electronics Canada Limited

9251 Yonge Street, Suite 8309 Richmond Hill, Ontario Canada L4C 9T3
Tel: +1-905-237-2004

Renesas Electronics Europe Limited

Dukes Meadow, Millboard Road, Bourne End, Buckinghamshire, SL8 5FH, U.K
Tel: +44-1628-651-700, Fax: +44-1628-651-804

Renesas Electronics Europe GmbH

Arcadiastrasse 10, 40472 Düsseldorf, Germany
Tel: +49-211-6503-0, Fax: +49-211-6503-1327

Renesas Electronics (China) Co., Ltd.

Room 1709 Quantum Plaza, No.27 ZhichunLu, Haidian District, Beijing, 100191 P. R. China
Tel: +86-10-8235-1155, Fax: +86-10-8235-7679

Renesas Electronics (Shanghai) Co., Ltd.

Unit 301, Tower A, Central Towers, 555 Langao Road, Putuo District, Shanghai, 200333 P. R. China
Tel: +86-21-2226-0888, Fax: +86-21-2226-0999

Renesas Electronics Hong Kong Limited

Unit 1601-1611, 16/F., Tower 2, Grand Century Place, 193 Prince Edward Road West, Mongkok, Kowloon, Hong Kong
Tel: +852-2265-6688, Fax: +852 2886-9022

Renesas Electronics Taiwan Co., Ltd.

13F, No. 363, Fu Shing North Road, Taipei 10543, Taiwan
Tel: +886-2-8175-9600, Fax: +886 2-8175-9670

Renesas Electronics Singapore Pte. Ltd.

80 Bendemeer Road, Unit #06-02 Hyflux Innovation Centre, Singapore 339949
Tel: +65-6213-0200, Fax: +65-6213-0300

Renesas Electronics Malaysia Sdn.Bhd.

Unit 1207, Block B, Menara Amcorp, Amcorp Trade Centre, No. 18, Jln Persiaran Barat, 46050 Petaling Jaya, Selangor Darul Ehsan, Malaysia
Tel: +60-3-7955-9390, Fax: +60-3-7955-9510

Renesas Electronics India Pvt. Ltd.

No.777C, 100 Feet Road, HAL 2nd Stage, Indiranagar, Bangalore 560 038, India
Tel: +91-80-67208700, Fax: +91-80-67208777

Renesas Electronics Korea Co., Ltd.

17F, KAMCO Yangjae Tower, 262, Gangnam-daero, Gangnam-gu, Seoul, 06265 Korea
Tel: +82-2-558-3737, Fax: +82-2-558-5338

ISL8117ADEMO3Z

RENESAS