

Features

- 2W power in SMD or DIP8 package
- 4:1 Input voltage range
- Efficiency up to 81%
- 1.6kVDC/1min isolation
- Regulated output
- -40°C to +85°C at full load
- Continuous short circuit protected

Regulated Converters

R2M

**2 Watt
DIP8 & SMD
Single & Dual
Output**



Description

The R2M is an isolated 2W DC/DC converter in a compact SMD package or DIP8 package available with 4:1 inputs covering 5, 12, 24, and 48V rails providing single or dual regulated, short-circuit protected outputs. There is no minimum load requirement. Isolation is 1.6kVDC/1min, and the operating temperature is from -40°C up to +85°C without derating. Class A and Class B EMC conformity requires only a few external components. Standard packaging is tube.

Selection Guide

Part Number	Input Voltage Range ⁽¹⁾ [VDC]	nom. Output Voltage [VDC]	Output Current [mA]	Efficiency typ. ⁽²⁾ [%]	max. Capacitive Load ⁽³⁾ [µF]
R2M-xx3.3S	4.5-18, 9-36, 18-75	3.3	500	77-78	2200
R2M-xx05S	4.5-18, 9-36, 18-75	5	400	78-79	1000
R2M-xx09S	4.5-18, 9-36, 18-75	9	222	79	660
R2M-xx12S	4.5-18, 9-36, 18-75	12	167	81	550
R2M-xx15S	4.5-18, 9-36, 18-75	15	134	81	440
R2M-xx24S	4.5-18, 9-36, 18-75	24	83	80	200
R2M-xx05D	4.5-18, 9-36, 18-75	±5	±200	77	±660
R2M-xx12D	4.5-18, 9-36, 18-75	±12	±83	80	±330
R2M-xx15D	4.5-18, 9-36, 18-75	±15	±67	81	±200

Notes:

- Note1: Refer to "Input Voltage Range"
- Note2: Efficiency is tested at nominal input and full load at +25°C ambient
- Note3: Max Cap Load is tested at nominal input and full resistive load

Model Numbering



Notes:

Note4: add suffix "/SMD" for SMD version, or leave blank for DIP8 THT version.

Specifications (measured @ Ta= 25°C, nom. Vin, full load and after warm-up unless otherwise stated)

BASIC CHARACTERISTICS				
Parameter	Condition	Min.	Typ.	Max.
Input Voltage Range	nom. V _{IN} = 12VDC	4.5VDC	12VDC	18VDC
	nom. V _{IN} = 24VDC	9VDC	24VDC	36VDC
	nom. V _{IN} = 48VDC	18VDC	48VDC	75VDC
Input Surge Voltage	1 second max.	nom. V _{IN} = 12VDC		25VDC
		nom. V _{IN} = 24VDC		50VDC
		nom. V _{IN} = 48VDC		100VDC

continued on next page

Specifications (measured @ Ta= 25°C, nom. Vin, full load and after warm-up unless otherwise stated)

BASIC CHARACTERISTICS

Parameter	Condition	Min.	Typ.	Max.
Quiescent Current	nom. V_{IN} = 12VDC		40mA	
	nom. V_{IN} = 24VDC		20mA	
	nom. V_{IN} = 48VDC		15mA	
Start-up time	power up, CTRL ON/OFF		10ms	20ms
ON/OFF CTRL ⁽⁵⁾	DC-DC ON		open or high impedance	
	DC-DC OFF	2mA	3mA	4mA
Standby Current	DC-DC OFF		2.5mA	
Internal Operating Frequency		100kHz		
Output Ripple and Noise	20MHz BW		50mVp-p	
Reflected Back Ripple Current	with external components	nom. V_{IN} = 12VDC	30mA	p-p
		nom. V_{IN} = 24VDC	30mA	p-p
		nom. V_{IN} = 48VDC	20mA	p-p

Notes:

Note5: Refer to "ON/OFF CTRL"

R2M-2405S/SMD

Efficiency vs. Load

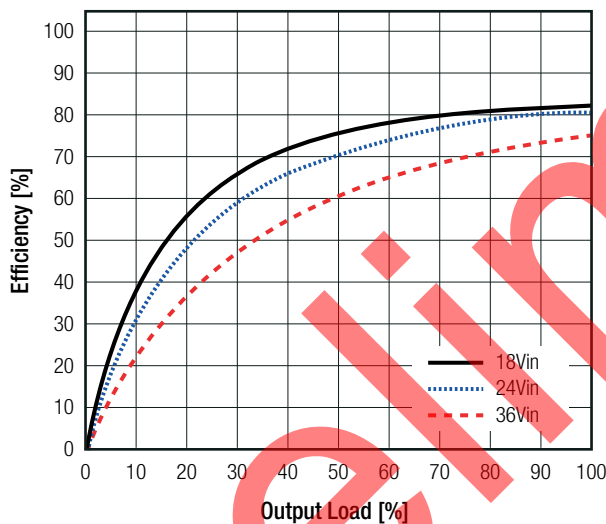

Power Dissipation vs. Load

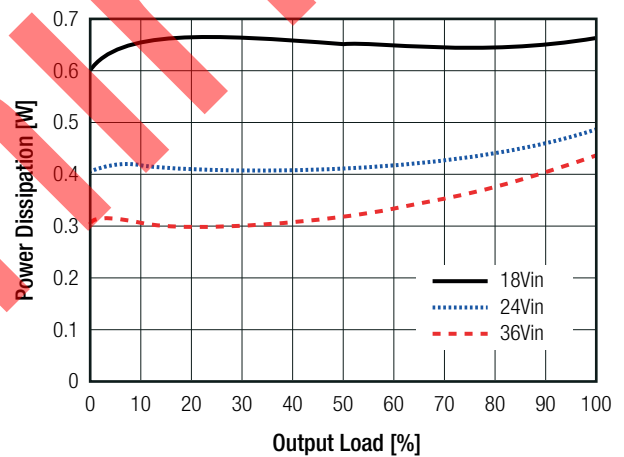

R2M-4812S/SMD

Efficiency vs. Load

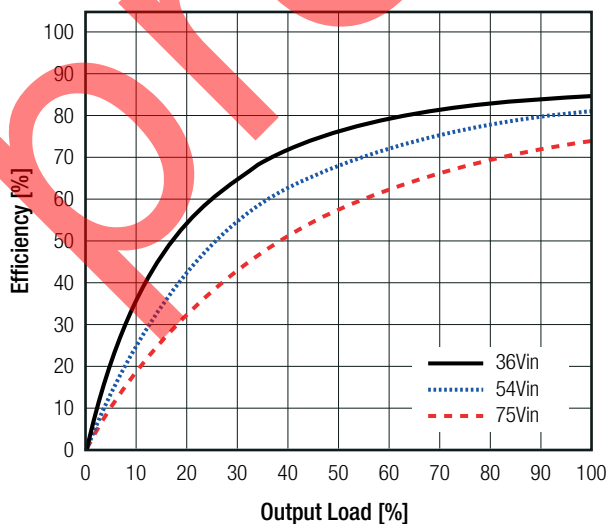

Power Dissipation vs. Load

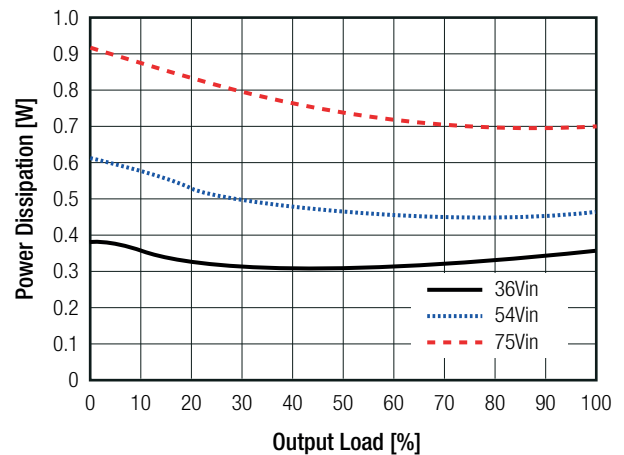

continued on next page

Specifications (measured @ $T_a = 25^\circ\text{C}$, nom. V_{in} , full load and after warm-up unless otherwise stated)

R2M-1212S/THT

Efficiency vs. Load

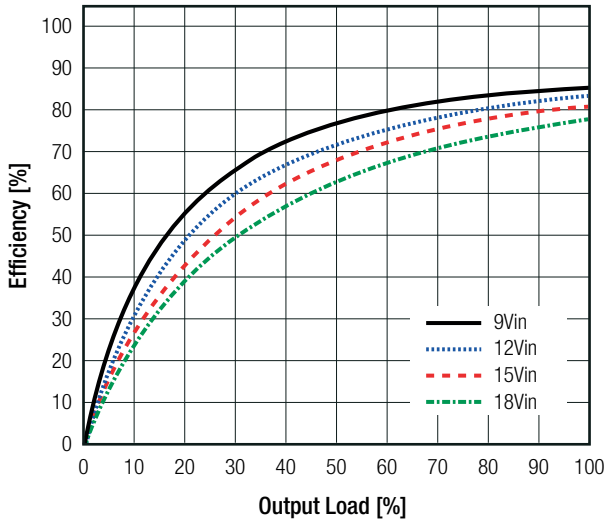

Power Dissipation vs. Load

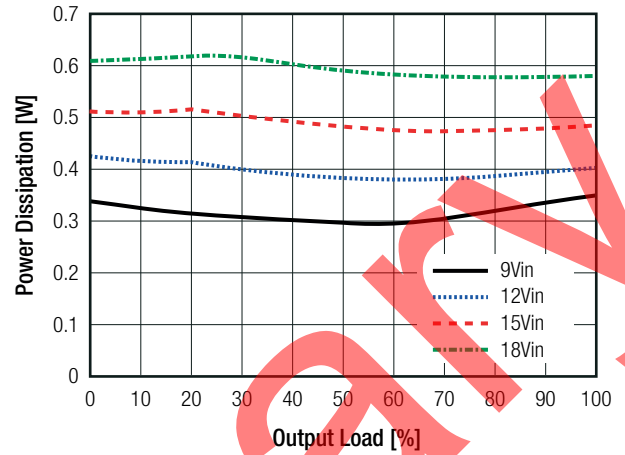

R2M-2405D/THT

Efficiency vs. Load

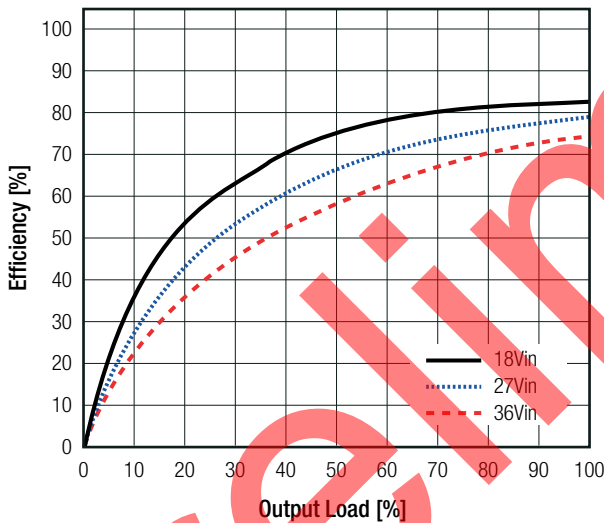

Power Dissipation vs. Load

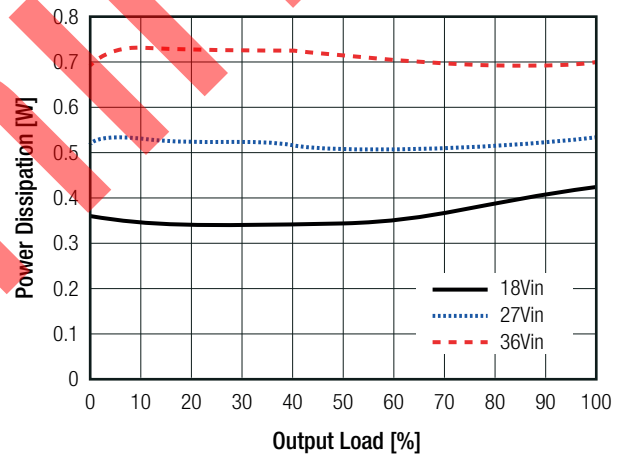

ON/OFF CTRL

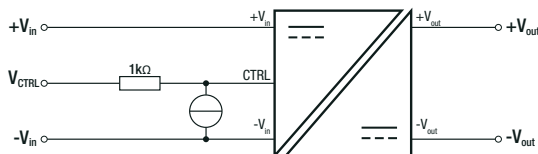

DC-DC ON	Open or high impedance
DC-DC OFF	2.0mA to 4.0mA max.

Specifications (measured @ Ta= 25°C, nom. Vin, full load and after warm-up unless otherwise stated)

REGULATIONS			
Parameter	Condition	Value	
Output Accuracy		±1.0% max.	
Line Regulation	low line to high line, full load	±0.2% max.	
Load Regulation	0% to 100% load	single	1% max.
		dual	1% max.
	10% to 90% load	single	0.5% max.
		dual	0.8% max.
Cross Regulation	asymmetrical 25% / 100% load	±5% max.	
Transient Response Recovery Time	25% load step change	±250µs typ.	

PROTECTIONS		
Parameter	Type	Value
Short Circuit Protection (SCP)		continuous, auto recovery
Isolation Voltage ⁽⁶⁾	I/P to O/P	1 minute
Isolation Resistance	I/P to O/P, V _{iso} = 500VDC	1GΩ min.
Isolation Capacitance	I/P to O/P, 100kHz/0.1V	50pF typ.
<p>Notes: Note6: This power module is not internally fused. An input line fuse must always be used Recom suggests: 12Vin=T1A; 24Vin=T0.5A; 48Vin=T0.315A slow blow</p>		

ENVIRONMENTAL		
Parameter	Condition	Value
Operating Temperature Range	with derating	-40°C to +105°C
	without derating	-40°C to +85°C
Maximum Case Temperature	measured at "tc point"	+105°C
Operating Humidity	non-condensing	5% - 95% RH max.
Thermal Shock		according to MIL-STD-810F
Vibration		according to MIL-STD-810F
MTBF	according to MIL-HDBK-217F, G.B.	+25°C
		6670 x 10 ³ hours

Derating Graph
(@ Chamber and natural convection 0.1m/s)

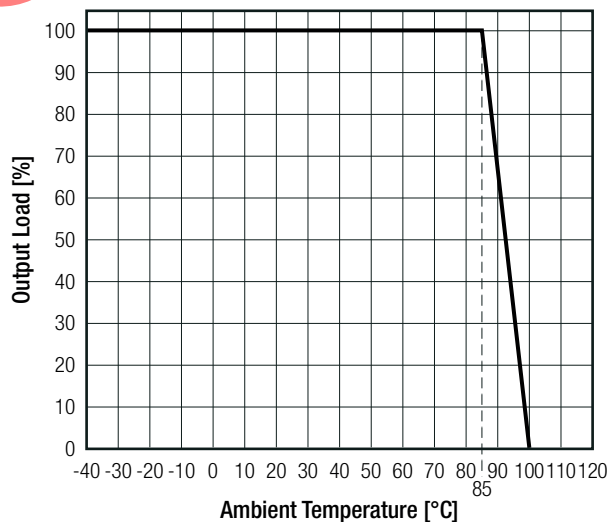

Specifications (measured @ $T_a = 25^\circ\text{C}$, nom. V_{in} , full load and after warm-up unless otherwise stated)

SAFETY AND CERTIFICATIONS

Certificate Type (Safety)	File Number	Standard
RoHS2		RoHS-2011/65/EU + AM-2015/863
EMC Compliance	Condition	Standard / Criterion
Electromagnetic compatibility of multimedia equipment – Emission Requirements	with external filter refer to “EMC Filtering”	EN55032, Class A and B

EMC Filtering Suggestions according to EN55032

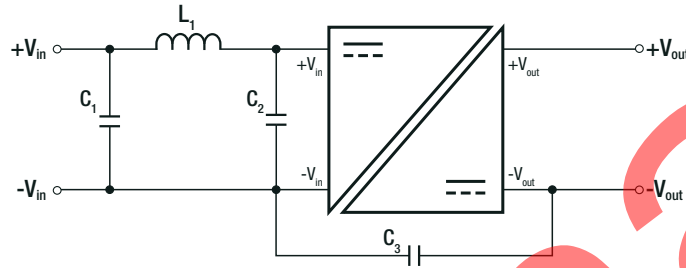

Class A Component List

Model	C1	C2	C3	L1
R2M-12xxS	22 μF	N/A	220pF	6.8 μH
R2M-24xxS	10 μF	N/A	470pF	15 μH
R2M-48xxS	2.2 μF	N/A	680pF	68 μH

Class B Component List

Model	C1, C2	C3	L1
R2M-12xxS	22 μF	220pF	6.8 μH
R2M-24xxS	10 μF	470pF	15 μH
R2M-48xxS	2.2 μF	680pF	68 μH

Specifications (measured @ Ta= 25°C, nom. Vin, full load and after warm-up unless otherwise stated)

DIMENSION AND PHYSICAL CHARACTERISTICS

Parameter	Type	Value
Material	baseplate/case	black plastic (UL94 V-0)
	potting	silicone (UL94 V-0)
Dimension (LxWxH)		14.2 x 9.1 x 10.2mm
Weight		2.7g typ.

Dimension Drawing standard "/SMD" version (mm)

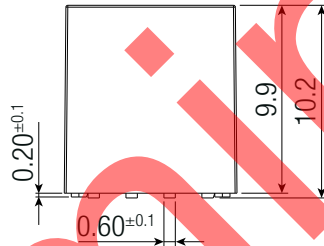
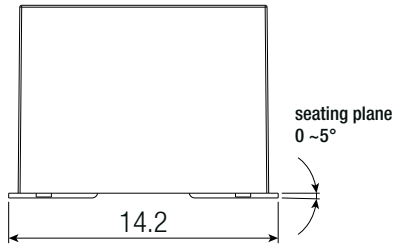
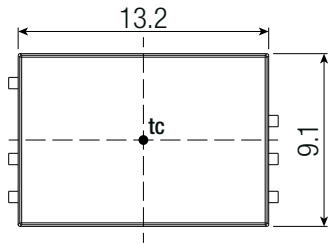

Pinning Information

Pin #	Single	Dual
1	+Vin	+Vin
2	-Vin	-Vin
4	CTRL	CTRL
5	NC	-Vout
6	-Vout	COM
7	+Vout	+Vout

NC= no connection

Recommended Footprint Details

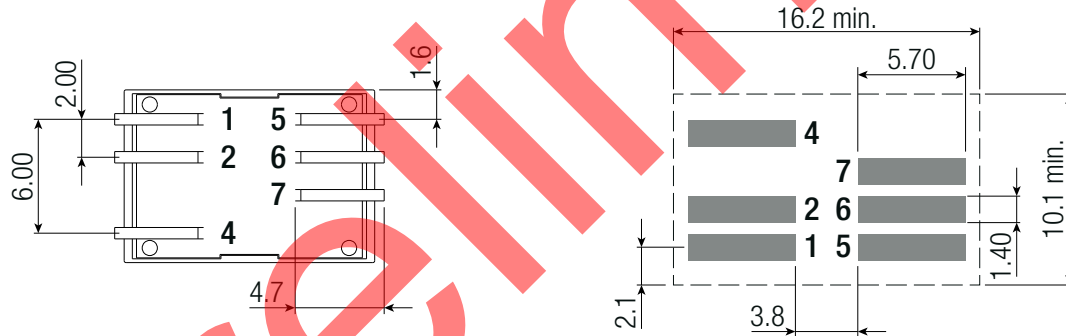

Tolerance:
xx.x = ±0.5mm
xx.xx = ±0.25mm

Specifications (measured @ Ta= 25°C, nom. Vin, full load and after warm-up unless otherwise stated)

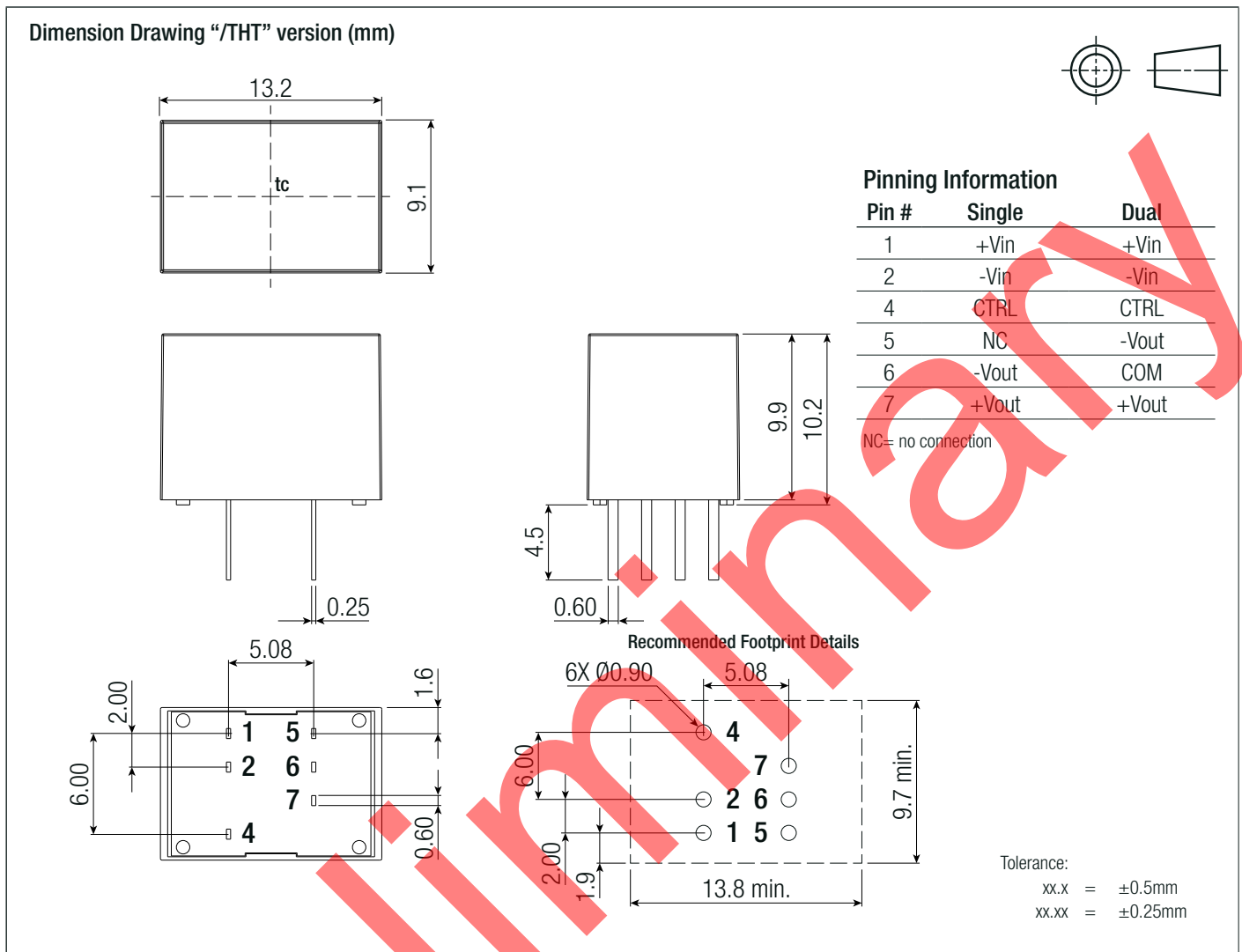

PACKAGING INFORMATION		
Parameter	Type	Value
Packaging Dimension (LxWxH)	tube	218.0 x 17.2 x 19.9mm
Packaging Quantity		20pcs
Storage Temperature Range	non-condensing	-55°C to +125°C
Storage Humidity		5% to 95% RH max.

The product information and specifications may be subject to changes even without prior written notice. The product has been designed for various applications; its suitability lies in the responsibility of each customer. The products are not authorized for use in safety-critical applications without RECOM's explicit written consent. A safety-critical application is an application where a failure may reasonably be expected to endanger or cause loss of life, inflict bodily harm or damage property. The applicant shall indemnify and hold harmless RECOM, its affiliated companies and its representatives against any damage claims in connection with the unauthorized use of RECOM products in such safety-critical applications.