

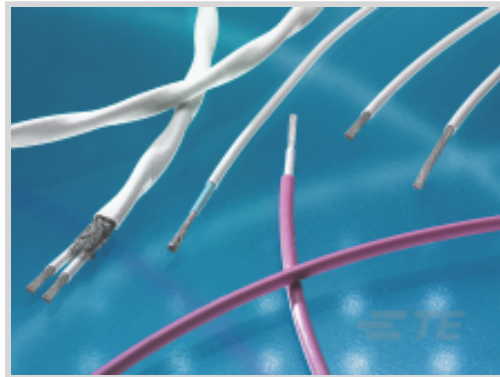

Wire & Cable > Hook Up Wire



Cable Type: **Spec 55**

Voltage Rating: **450 V**

Insulation Material: **Modified Radiation Cross-linked ETFE Polymer**

Conductor Material: **Silver-Coated High Strength Copper Alloy**

Wire Size: **24 AWG**

Features

Product Type Features

Cable Type	Spec 55
------------	---------

Electrical Characteristics

Voltage Rating	450 V
----------------	-------

Body Features

Insulation Material	Modified Radiation Cross-linked ETFE Polymer
---------------------	--

Conductor Material	Silver-Coated High Strength Copper Alloy
--------------------	--

Dimensions

Wire Size	24 AWG
-----------	--------

Usage Conditions

Operating Temperature Range	-65 – 200 °C
-----------------------------	--------------

Product Compliance

[For compliance documentation, visit the product page on TE.com>](#)

EU RoHS Directive 2011/65/EU	Compliant
------------------------------	-----------

EU ELV Directive 2000/53/EC	Compliant
-----------------------------	-----------

China RoHS 2 Directive MIIT Order No 32, 2016	No Restricted Materials Above Threshold
---	---

EU REACH Regulation (EC) No. 1907/2006	Current ECHA Candidate List: JAN 2019 (197)
--	---

Candidate List Declared Against: JAN 2019
 (197)

Halogen Content	Out of Scope - excluded from Halogen requirements
Solder Process Capability	Not applicable for solder process capability

Product Compliance Disclaimer

This information is provided based on reasonable inquiry of our suppliers and represents our current actual knowledge based on the information they provided. This information is subject to change. The part numbers that TE has identified as EU RoHS compliant have a maximum concentration of 0.1% by weight in homogenous materials for lead, hexavalent chromium, mercury, PBB, PBDE, DBP, BBP, DEHP, DIBP, and 0.01% for cadmium, or qualify for an exemption to these limits as defined in the Annexes of Directive 2011/65/EU (RoHS2). Finished electrical and electronic equipment products will be CE marked as required by Directive 2011/65/EU. Components may not be CE marked. Additionally, the part numbers that TE has identified as EU ELV compliant have a maximum concentration of 0.1% by weight in homogenous materials for lead, hexavalent chromium, and mercury, and 0.01% for cadmium, or qualify for an exemption to these limits as defined in the Annexes of Directive 2000/53/EC (ELV). Regarding the REACH Regulations, TE's information on SVHC in articles for this part number is still based on the European Chemical Agency (ECHA) 'Guidance on requirements for substances in articles' (Version: 2, April 2011), applying the 0.1% weight on weight concentration threshold at the finished product level. TE is aware of the European Court of Justice ruling of September 10th, 2015 also known as O5A (Once An Article Always An Article) stating that, in case of 'complex object', the threshold for a SVHC must be applied to both the product as a whole and simultaneously to each of the articles forming part of its composition. TE has evaluated this ruling based on the new ECHA "Guidance on requirements for substances in articles" (June 2017, version 4.0) and will be updating its statements accordingly.

Compatible Parts

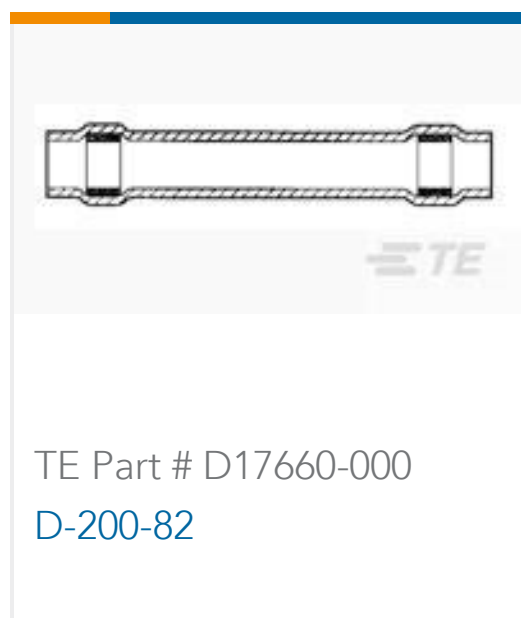

TE Part # D17660-000
[D-200-82](#)

Customers Also Bought



TE Part #D09793-000
[224W511-25-0](#)



TE Part #883099-000
[222A111-25-G07-0](#)

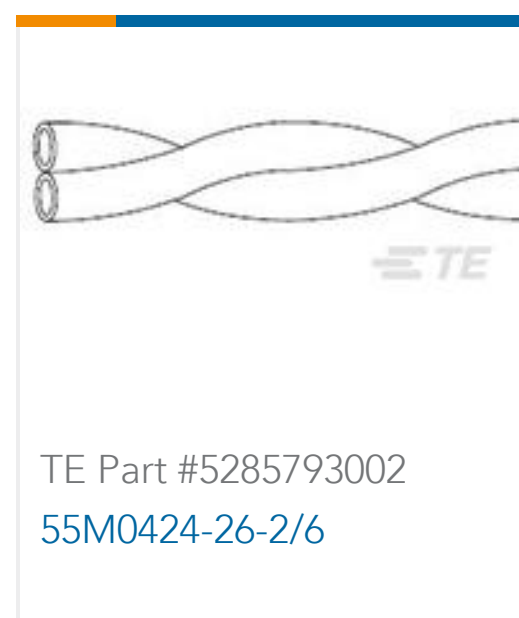

TE Part #5285793002
[55M0424-26-2/6](#)

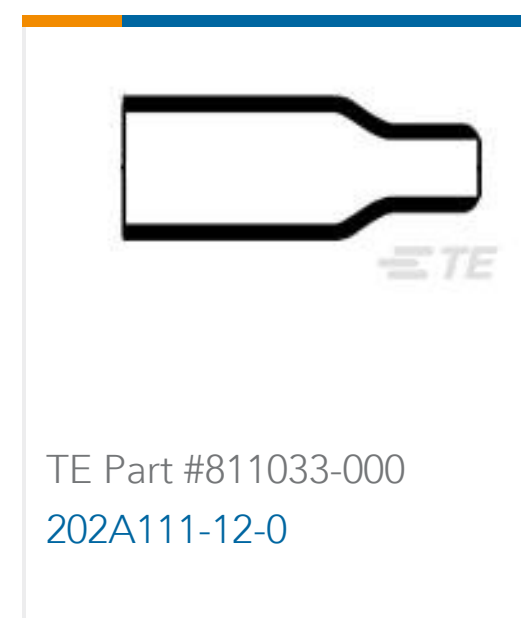

TE Part #811033-000
[202A111-12-0](#)

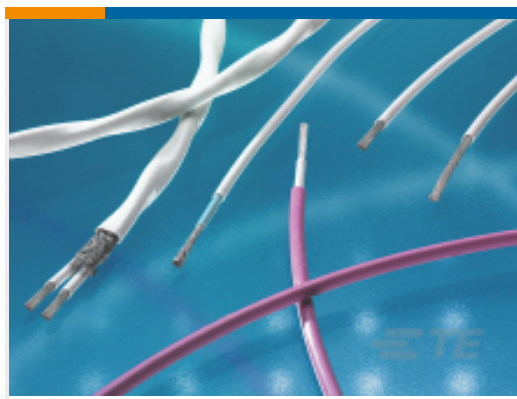

TE Part #7487473001
55M0414-24-9

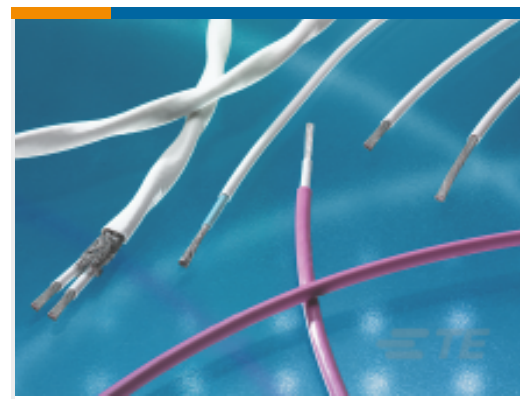

TE Part #2249233001
55M0414-24-6

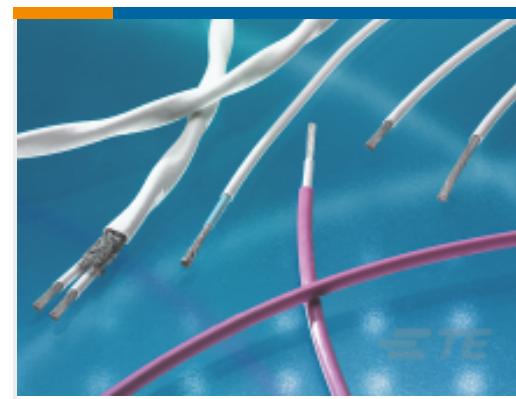

TE Part #1316093001
55M0414-24-0

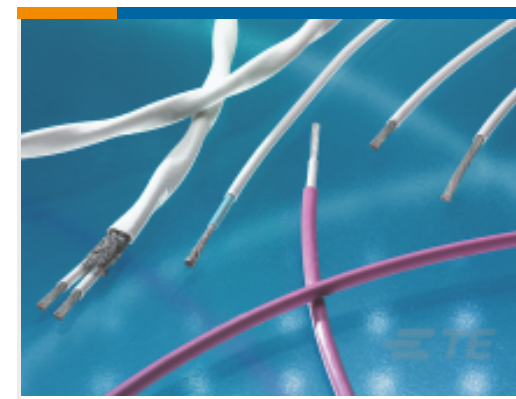

TE Part #0624813001
55M0424-24-2/6



TE Part #0201604001
RNF-3000-1.5/0.5-7-SP

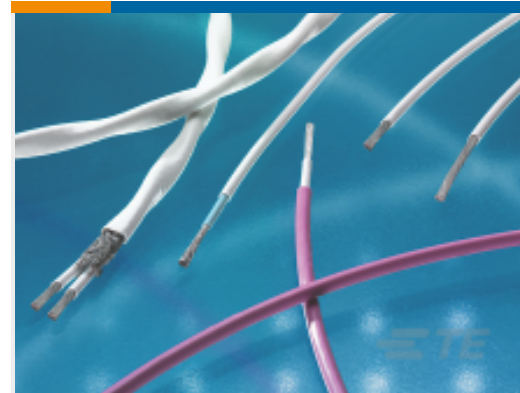

TE Part #0789883001
55M1424-24-2/6-9

Documents

Product Drawings

55M0414-24-2

English

Datasheets & Catalog Pages

1654025_Sec9_SPEC55

English

Product Specifications

Product Specification

English