

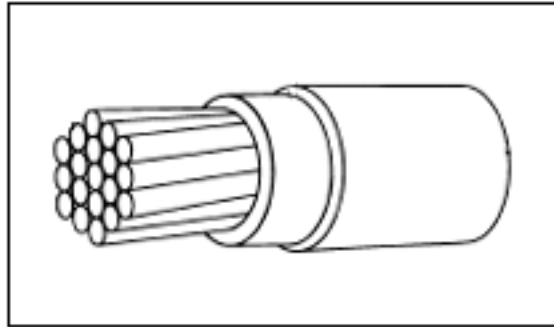

## 22759/35-24-9 Product Details

[Share](#) [Print](#) [Email](#)

22759/35-24-9

TE Internal Number: 218167-001

[Active](#)

### Spec 44, Spec 55 and Spec RCW Wire and Cable

[Converted to EU RoHS/ELV Compliant \(Statement of Compliance\)](#)

#### Product Highlights:

- Cable Type = Spec 55
- Wire Source = United States
- Cable Style = Primary
- Wire Size (AWG/CM) = 24 AWG
- Voltage Rating = 600 VAC

[View all Features](#)

#### Quick Links

- ▶ [Check Pricing & Availability](#)
- ▶ [Search for Tooling](#)
- ▶ [Product Feature Selector](#)
- ▶ [Contact Us About This Product](#)

[Add to My Part List](#) [Request Sample](#) [Find Similar Products](#) [Buy Product](#)

### Documentation & Additional Information

#### Product Drawings:

- [WIRE, RADIATION-CROSSLINKED, MODIFIED ETFE-INSULATED...](#) (PDF, English)

#### Catalog Pages/Data Sheets:

- None Available

#### Product Specifications:

- None Available

#### Application Specifications:

- None Available

#### Instruction Sheets:

- None Available

#### CAD Files:

- None Available

#### Related Products:

- [Tooling](#)

[List all Documents](#)

### Product Features (Please use the Product Drawing for all design activity)

#### Product Type Features:

- [Cable Type](#) = Spec 55
- [Cable Style](#) = Primary
- Number of Conductors = 1

#### Electrical Characteristics:

- Voltage Rating (VAC) = 600

#### Body Features:

- Wire Size (AWG/CM) = 24 AWG
- Conductor Type = Silver-Coated High-Strength Copper Alloy
- Wire Color = White
- Nominal Outside Diameter (mm [in]) = 0.94 [0.037]
- Wire Diameter (mm [in]) = 0.94 [0.037]
- Conductor O.D. (mm [in]) = 0.64 [0.025]

#### Industry Standards:

- Government/Industry Qualification = Yes
- Government/Industry Part Number = M22759/35-24-9
- [RoHS/ELV Compliance](#) = RoHS compliant, ELV compliant
- [Lead Free Solder Processes](#) = Not relevant for lead free process
- RoHS/ELV Compliance History = Converted to comply with RoHS directive

#### Conditions for Usage:

- Temperature Range (°C) = -65 - +200
- Wire Size - Details = 24 AWG 0.24 mm<sup>2</sup>, 0.00037 in<sup>2</sup>, 19 x 36 AWG

#### Operation/Application:

- Application = Airframe - Medium Weight

#### Packaging Features:

- Wire Source = United States

#### Other:

- Brand = Raychem

### Corporate Information

[Who We Are](#)  
[Investors](#)  
[News Room](#)  
[Supplier Portal](#)  
[Careers](#)

### Quick Links

[Check Distributor Inventory](#)  
[Cross Reference](#)  
[Find Documents & Drawings](#)  
[Product Compliance Support Center](#)  
[Site Map](#)

### Customer Support

[Email or Chat With Us](#)  
[Find a Phone Number](#)  
[Search Knowledge Base](#)  
[Manage your Account](#)

### Keep Me Informed

Receive TE News, Events & Technology Updates

[▶](#)

