

PT-6

6-mm carbon through-hole trimmer potentiometer

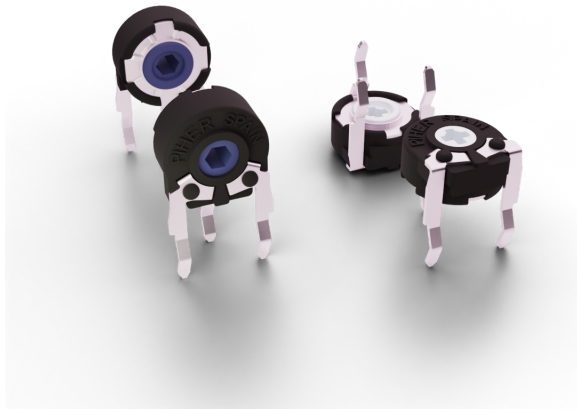

KEY FEATURES

- ▶ Excellent performance
- ▶ Carbon resistive element
- ▶ Up to 10 mechanical detents
- ▶ Up to 10.000 life cycles
- ▶ IP54 protection
- ▶ Magazines packaging for automatic insertion
- ▶ Polyester substrate
- ▶ Wiper positioned at initial, 50% or fully clockwise
- ▶ Loose and assembled shaft and knobs
- ▶ Linear, logarithmic and antilogarithmic tapers
- ▶ SPDT switch function

On request

- ▶ Embossed tape packaging

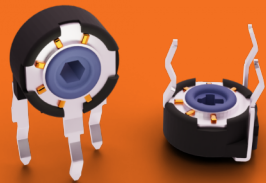

The **only 6 mm miniature trimmer**
potentiometer with optional
stop positions for haptic feedback.

ELECTRICAL SPECIFICATIONS

Taper*	Lin, Log, Alog
Range of values*	(Decad. 1.0 - 2.0 - 2.2 - 2.5 - 4.7 - 5.0)
Lin	$220\Omega \leq R_n \leq 5M\Omega$
Log, Alog	$1K\Omega \leq R_n \leq 5M\Omega$
Tolerance*	
$220\Omega \leq R_n \leq 1M\Omega$	± 20%
$1M\Omega < R_n \leq 5M\Omega$	± 30%
Max. Voltage	
Lin	100 VDC
Log, Alog	50 VDC
Nominal power 50°C (122°F)	
Lin	0.1 W
Log, Alog	0.05 W
Residual resistance	≤ 0.5% R _n (5Ω min.)
Equivalent noise resistance	≤ 3% R _n (3Ω min.)
Operating temperature**	-25°C to +70°C (-13°F to + 158°F)

* Others available on request

** Up to 85°C depending on application.

APPLICATIONS

- ▶ Appliance program selection
- ▶ Thermostat adjustment
- ▶ Timer and control relays
- ▶ Consumer electronics
- ▶ Power tool controls
- ▶ Test and measurement equipment

PT-6

6-mm carbon through-hole trimmer potentiometer

MECHANICAL SPECIFICATIONS

Mechanical rotation angle	235° ± 5°
Electrical rotation angle*	200° ± 20°
Torque Rotational Stop	0.2 to 2 Ncm (0.3 to 2.7 in-oz) > 4 Ncm (>7 in-oz)
Life**	up to 10.000 cycles

*Increased rotational angle of 215°± 20° available upon request ** Others available on request

ENVIRONMENTAL TESTING

	Test conditions (CEI 393-1)	ΔR(%) - Typical test results
Electrical life	1.000h at 50°C; 0.1 W	±5%
Mechanical life	1000 cycles at 10 to 15 cpm	±3% (Rn < 1M)
Temperature coefficient	-25° C; +70° C	±300 ppm/°C C (Rn < 100K)
Thermal cycling	16h at 85°C and 2h at -25°C	±2.5%
Damp heat	500h at 40°C and 95% relative humidity (RH)	±5%
Vibration	2h each plane at 10Hz - 55Hz	±2%
Storage	6 month at 23°C ±2°C and 50% RH	±2.5%

Out of range values may not comply with these results. Standard test conditions: temperature: 23°C ±2°C and 45% to 70% RH. Mechanical life of detented versions is 100 cycles

RECOMMENDED CONNECTIONS

Recommended connection circuit for a position sensor or control application (voltage divider circuit electronic design).

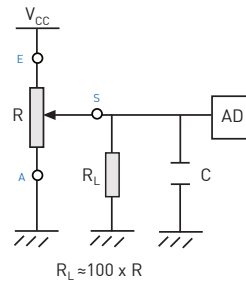

POWER RATING CURVE

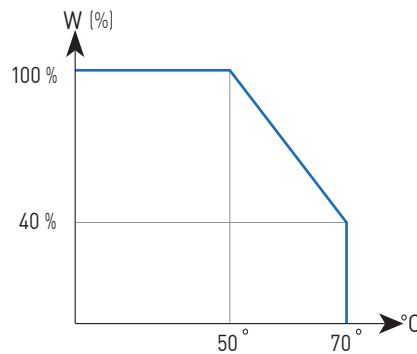

PT-6

6-mm carbon through-hole trimmer potentiometer

HOW TO ORDER

Example: PT6KV-221A2020

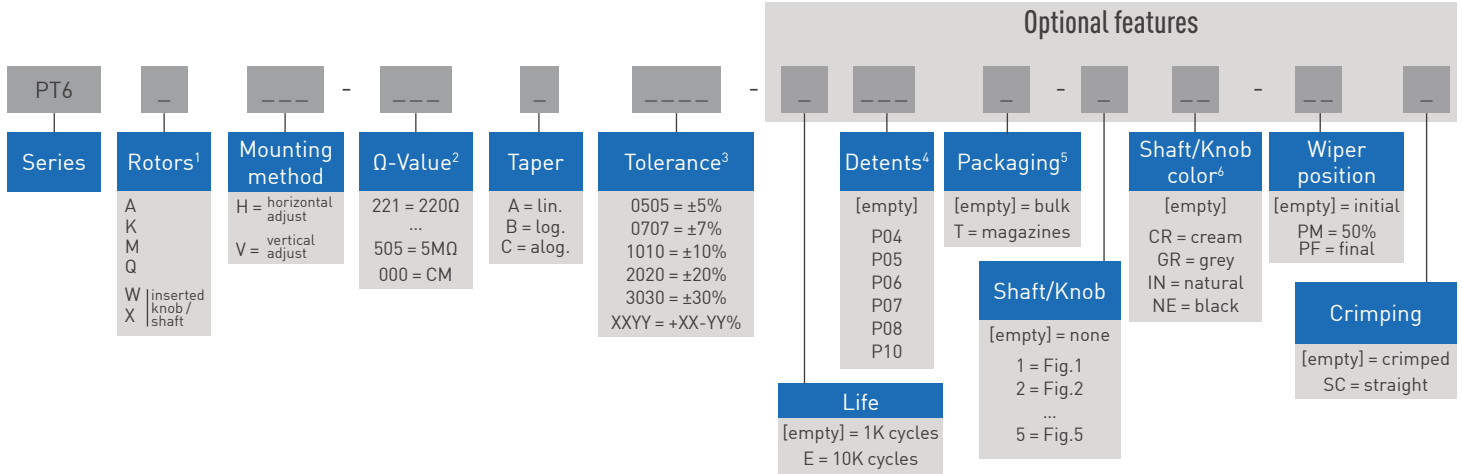

1. Rotors: "X" rotor only available on "H" mounting versions. Default color is white. Other rotor colours on request.

2. Ω- Value: XXX - First two digits of Ω-value 000 = CM = switch SPDT version
XXX - Number of zeros

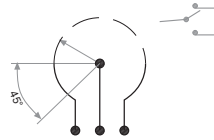

3. Tolerance: for custom tolerance please check availability at info@piher.net

4. Detents: Detented versions use purple rotor color (rotor color code "VI"). Ordering code example: PT6KH-254A2020-P04-VI

5. Packaging: Only for "V" mounting method. "W" rotor with shaft Fig. 2 is not available in magazines. Embossed tape packaging on request.

6. Default colour for knob/shaft is cream

DEFAULT CONFIGURATION

PT-6	
Life	1.000 cycles (forth and back the mechanical angle travel)
Detents	none
Housing color	black
Rotor color	white
Wiper Position	initial
Packaging	bulk

ORDER CODE EXAMPLES

PT6WV-104A1010-5NE-SC

6mm potentiometer with factory pre-inserted knob, V mounting method (vertical adjustment), 100K resistive value, linear taper, 10% resistive tolerance, black knob ref. 6148 and straight terminals (not crimped).

PT6KH-103A2020

6mm potentiometer with rotor "K" (cross shape), H mounting method (horizontal adjustment), 10K resistive value, linear taper, 20% resistive tolerance and crimped terminals.

PT-6

6-mm carbon through-hole trimmer potentiometer

ROTORS

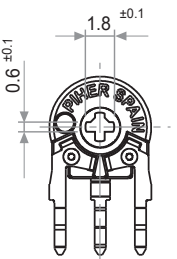
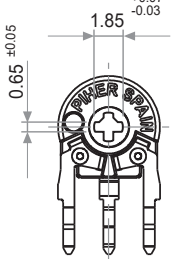
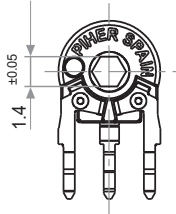
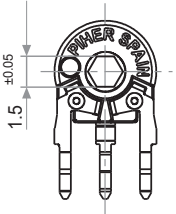
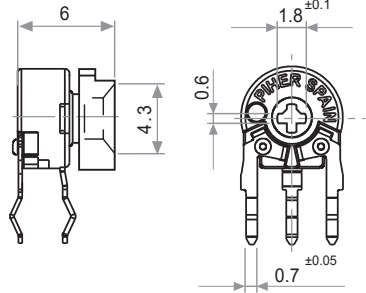
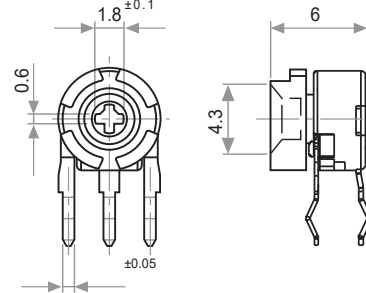
K Cross slot through hole	Q Cross slot through hole colour: pink	M Hexagonal through hole	A Hexagonal through hole colour: pink
			
X Adjustable from collector side		W Adjustable from terminal side	
 <p>With inserted knob / shaft. Example with knob ref. 5155</p>		 <p>With inserted knob / shaft. Example with knob ref. 5155</p>	

Default delivery is at initial position. Wipers are shown positioned at 50% for the picture.

MOUNTING METHOD

V = Vertical Adjustment - Horizontal Mounting

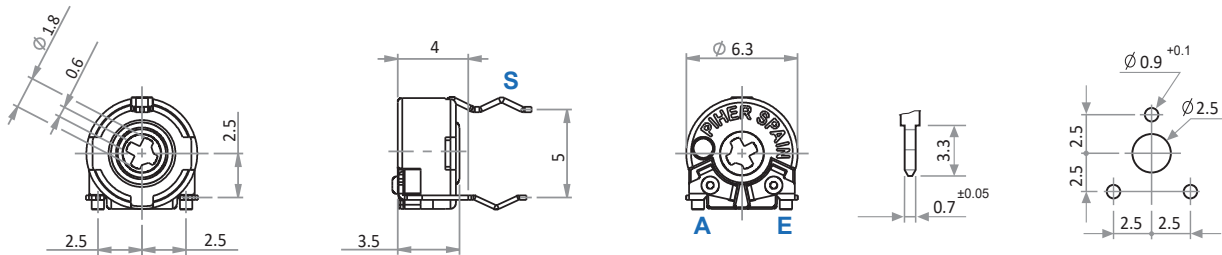

H = Horizontal Adjustment - Vertical Mounting

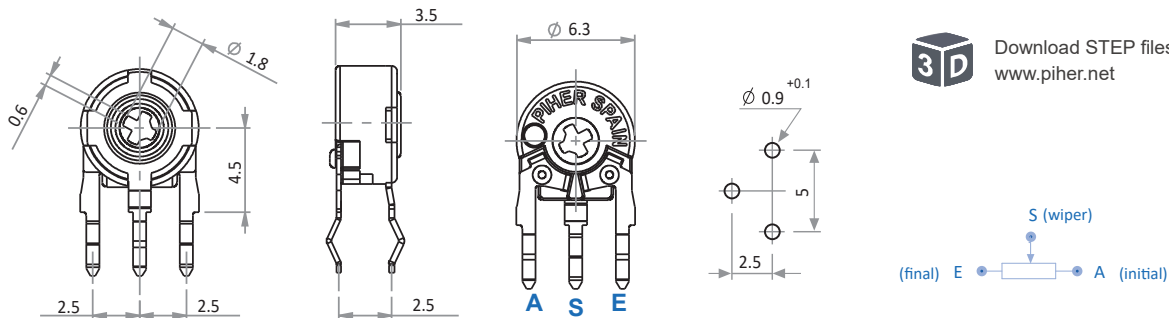

PT-6

6-mm carbon through-hole trimmer potentiometer

CRIMPING

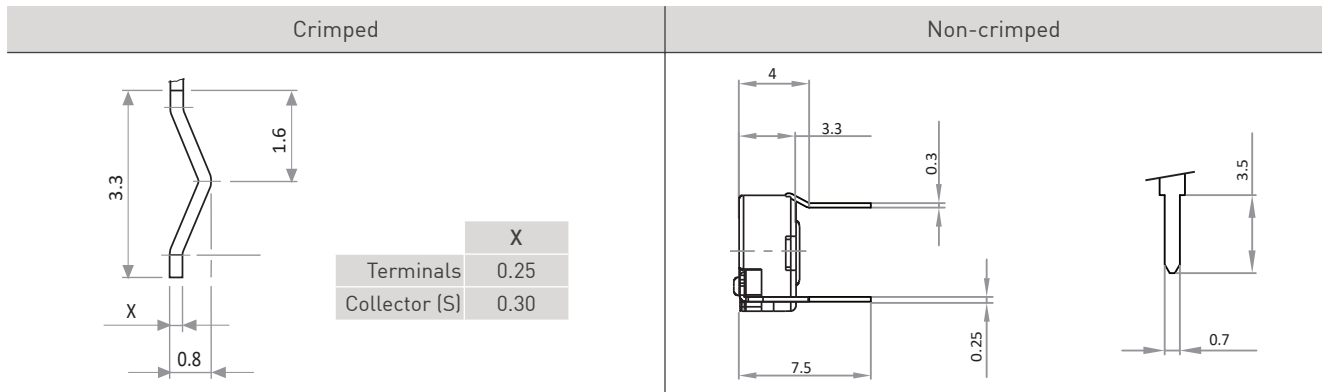

SMD MOUNTING AVAILABLE

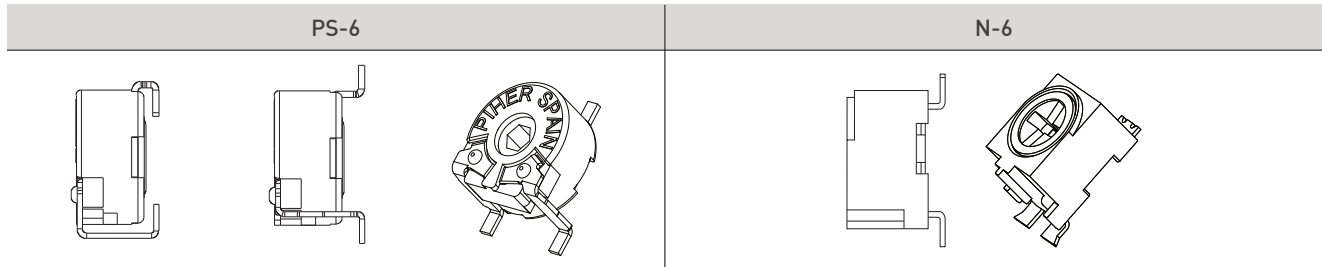

For more information visit: www.piher.net

STANDARD RESISTANCE-VALUES AND TOLERANCES

Resistance Ω	100	200	220	250	470	500	1K	2K	2.2K	2.5K	4.7K	5K	10K	20K	22K	25K	47K	50K	100K	200K	220K	250K	470K	500K	1M	2M	2.5M	4.7M	5M
Order Code	101	201	221	251	471	501	102	202	222	252	472	502	103	203	223	253	473	503	104	204	224	254	474	504	105	205	255	475	505
Tolerance	30%														20%										30%				

TAPERS

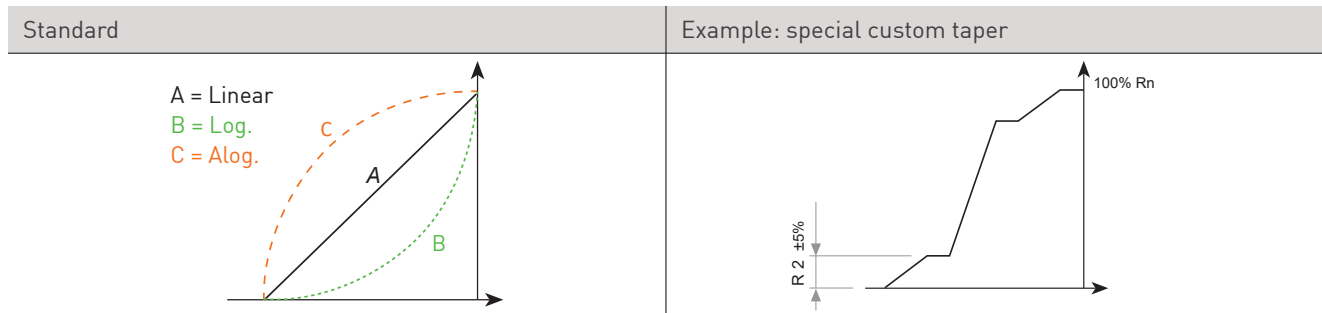

For more information on custom tapers contact Piher Sensing Systems.

SWITCH VERSION

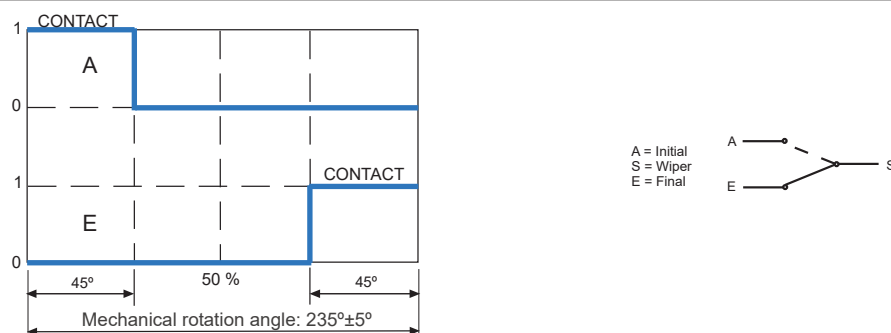

PT-6

6-mm carbon through-hole trimmer potentiometer

DETENTS / STOP POSITIONS

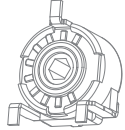
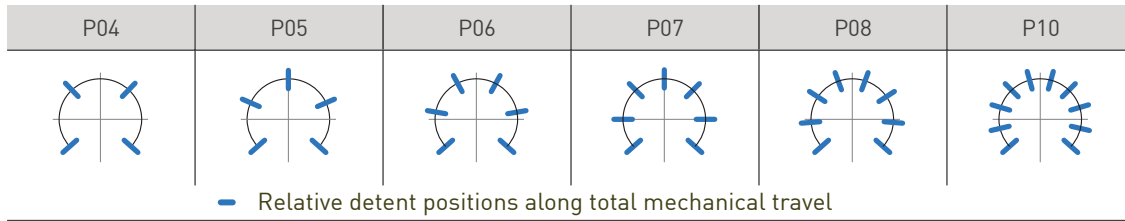

All detented versions will be studied case by case, more than 10 detents available on request.
 Unless otherwise specified the detents are evenly spaced (using the end points as reference).
 Standard mechanical life of detented versions: 100 cycles. Long life versions are available on request.
 Detent torque can vary from 1.2 to 2.5 times the standard potentiometer torque.
 Rotor color of detented versions is purple-violet.

PACKAGING

Bulk (1000 units per box)	Magazine / Automatic Insertion (80 units per magazine)	
All models	PT-6 V models	PT-6 WW models
Dimensions (mm): 185x85x40		

Embossed tape/reel packaging on request.

WIPER POSITION

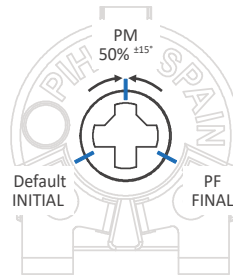

Wiper positioning on initial position is standard. Special delivery positions available on request.

DUAL GANG METAL SHAFT ON REQUEST - REF.: 6060

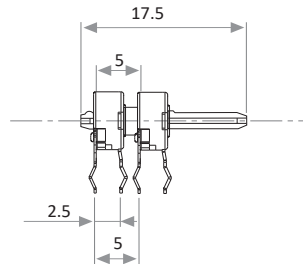

PT-6

6-mm carbon through-hole trimmer potentiometer

KNOBS / SHAFTS (FOR K ROTOR)

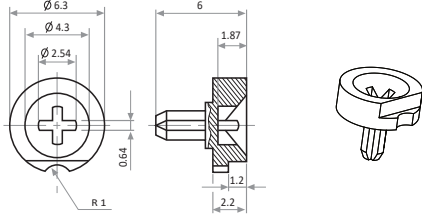
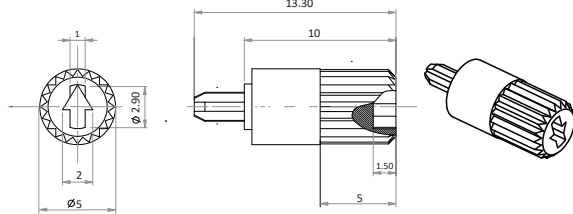
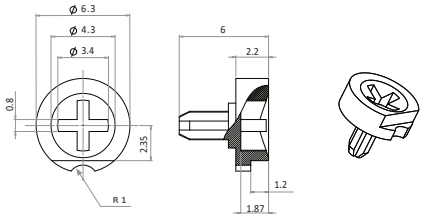
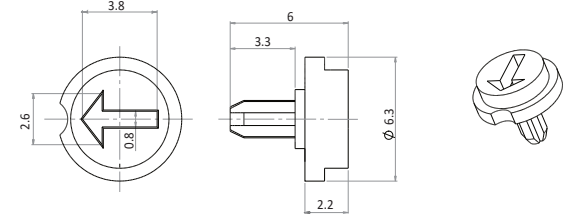
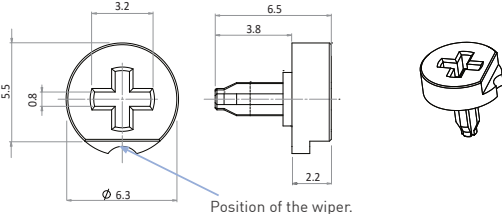
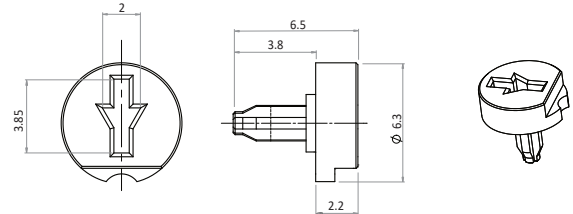
<p>Fig. 1 - Ref.: 5155 Colors available: white, cream and black. Default color: white.</p> 	<p>Fig. 2 - Ref. 6132 Shaft - Not suitable for magazine packaging Colours*: cream and black. Other colours upon request.</p> 
<p>Fig. 3 - Ref.: 5141 Color: grey*</p> 	<p>Fig. 4 - Ref.: 6172 Color*: grey</p> 
<p>Fig. 5 - Ref.: 6148 For V models only. Colors available: cream and black. Default color: cream.</p>  <p>Position of the wiper.</p>	<p>Fig. 6 - Ref.: 6160 For V models only. Colors available: cream and black. Default color: cream.</p> 

If you wish to use your own plastic shaft/knob/actuator please contact Piher Sensing Systems for advice about compatible materials.

Shaft and knobs (Fig 1 to 4) are delivered unassembled if not specified otherwise in part number code ("W" or "X"). The position of assembled knobs can be indicated in part number code: Initial (default), 50% (PM) or Final (PF). Mounted shaft Fig. 2 by standard will be delivered at random position. Custom specific positions are available for shaft and all knobs on request.

* We offer this product in other colors. Please contact us at info@piher.net to check availability.

OUR ADVANTAGE

- ▶ Leading-edge innovative position sensing solutions
 - ▷ Contactless (Hall-effect and Inductive Technology)
 - ▷ Contacting (Potentiometers, Printed Electronics)
- ▶ Engineering design-in support
- ▶ All our products can be customized to fit target application and customer requirement
- ▶ Capability to move seamlessly from development to true high-volume production
- ▶ A global footprint with global engineering and commercial support
- ▶ One-stop shop not limited to position sensors (temperature, pressure, gas,...) through group collaboration
- ▶ Flexibility and entrepreneurship of a medium-sized company with the backing of Amphenol Corporation



Please always use the latest updated datasheets and 3D models published on our website.

Disclaimer:

The product information in this catalog is for reference purposes. Please consult for the most up to date and accurate design information. Piher Sensors & Controls S.A., its affiliates, agents, and employees, and all persons acting on its or their behalf (collectively, "Piher"), disclaim any and all liability for any errors, inaccuracies or incompleteness contained herein or in any other disclosure relating to any product described herein. Piher disclaims any and all liability arising out of the use or application of any product described herein or of any information provided herein to the maximum extent permitted by law. The product specifications do not expand or otherwise modify Piher's terms and conditions of sale, including but not limited to the warranty expressed therein, which apply to these products. No license, express or implied, by estoppel or otherwise, to any intellectual property rights is granted by this document or by any conduct of Piher. The products shown herein are not designed for use in medical, life-saving, or life-sustaining applications unless otherwise expressly indicated. Customers using or selling Piher products not expressly indicated for use in such applications do so entirely at their own risk and agree to fully indemnify Piher for any damages arising or resulting from such use or sale. Please contact authorized Piher personnel to obtain written terms and conditions regarding products designed for such applications. Product names and markings noted herein may be trademarks of their respective owners. Information contained in and/or attached to this catalogue may be subject to export control regulations of the European Community, USA, or other countries. Each recipient of this document is responsible to ensure that usage and/or transfer of any information contained in this document complies with all relevant export control regulations. If you are in any doubt about the export control restrictions that apply to this information, please contact the sender immediately. For any Piher Exports. Note: All products / technologies are EAR99 Classified commodities. Exports from the United States are in accordance with the Export Administration Regulations. Diversion contrary to US law is prohibited.

Piher Sensing Systems
Polígono Industrial Municipal
Vial T2, N°22
31500 Tudela
Spain

sales@piher.net

Europe: +34 948 820 450
Americas: +1 636 251 0855
Asia Pacific: +65 9641 8886

Rev:29/02/24 © 2024 Piher Sensors & Controls S.A.