



Extract from the online catalog

MCDV 1,5/16-G-3,81

Order No.: 1830541

The figure shows a 10-position version of the product



<http://eshop.phoenixcontact.de/phoenix/treeViewClick.do?UID=1830541>

Header, Nominal current: 8 A, Nom. voltage: 160 V, Pitch: 3.81 mm, Number of positions: 16, Color: green, Assembly: Soldering

Commercial data	
EAN	4017918051235
Pack	50 pcs.
Customs tariff	85366990
Weight/Piece	0.013227 KG
Catalog page information	Page 184 (CC-2009)

Product notes

WEEE/RoHS-compliant since: 01/01/2003



<http://www.download.phoenixcontact.com>
Please note that the data given here has been taken from the online catalog. For comprehensive information and data, please refer to the user documentation. The General Terms and Conditions of Use apply to Internet downloads.

Technical data

Dimensions / positions	
Pitch	3.81 mm
Dimension a	57.15 mm
Number of positions	16
Pin dimensions	0,8 x 0,8 mm
Hole diameter	1.2 mm

MCDV 1,5/16-G-3,81 Order No.: 1830541
http://eshop.phoenixcontact.de/phoenix/treeViewClick.do?UID=1830541

Technical data

Insulating material group	IIIa
Rated surge voltage (III/3)	2.5 kV
Rated surge voltage (III/2)	2.5 kV
Rated surge voltage (II/2)	2.5 kV
Rated voltage (III/2)	160 V
Rated voltage (II/2)	250 V
Connection in acc. with standard	EN-VDE
Nominal current I_N	8 A
Nominal voltage U_N	160 V
Maximum load current	8 A
Insulating material	PBT
Inflammability class acc. to UL 94	V0

Certificates / Approvals



Certification CB, CSA, CUL, GOST, UL, VDE-PZI

CSA

Nominal voltage U_N	300 V
Nominal current I_N	8 A

CUL

Nominal voltage U_N	300 V
Nominal current I_N	8 A

UL

Nominal voltage U_N	300 V
Nominal current I_N	8 A

MCDV 1,5/16-G-3,81 Order No.: 1830541
<http://eshop.phoenixcontact.de/phoenix/treeViewClick.do?UID=1830541>

Diagrams/Drawings

Drilling plan/solder pad geometry

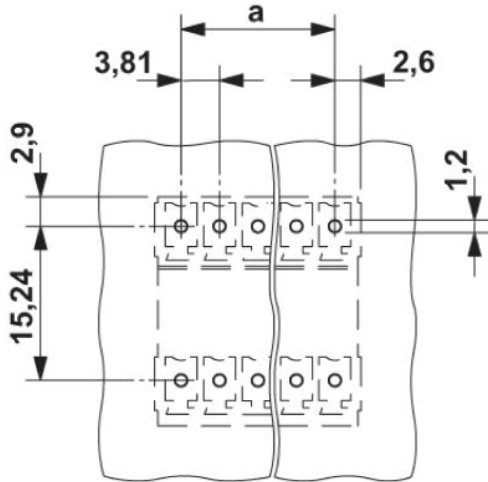

Dimensioned drawing

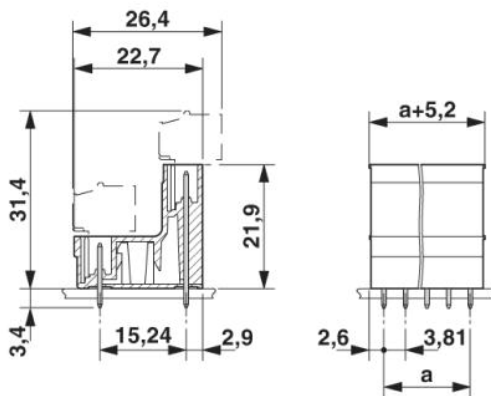

MCDV 1,5/16-G-3,81 Order No.: 1830541
<http://eshop.phoenixcontact.de/phoenix/treeViewClick.do?UID=1830541>

Address

PHOENIX CONTACT Deutschland GmbH
Flachmarktstr. 8
32825 Blomberg, Germany
Phone +49 5235 3 12000
Fax +49 5235 3 41200
<http://www.phoenixcontact.de>



© 2010 Phoenix Contact
Technical modifications reserved;

onlinecomponents.com