

CAPAROC PM PN - Feed-in module



1110986

<https://www.phoenixcontact.com/us/products/1110986>

Please be informed that the data shown in this PDF document is generated from our online catalog. Please find the complete data in the user documentation. Our general terms of use for downloads are valid.



Power module with PROFINET interface for supplying the CAPAROC circuit breaker system with 12 or 24 V DC. Additional system interface for communication with the power supply. For DIN rail installation via the CAPAROC current rails.

Your advantages

- The benchmark that you can customize by selecting single signals and resets all the way to PROFINET communication
- Particularly easy operation for everyone with tool-free assembly, direct feed-in to the busbar, and clear operating states
- Exceptionally easy design-in thanks to the comprehensive digital data packet and PROFINET function blocks

Commercial data

Item number	1110986
Packing unit	1 pc
Minimum order quantity	1 pc
Sales key	CL11
Product key	CLA231
GTIN	4063151020071
Weight per piece (including packing)	178.05 g
Weight per piece (excluding packing)	141.3 g
Customs tariff number	85363030
Country of origin	DE

Technical data

Notes

General

Note	LABS release – in accordance with test specification VW PV 3. 10.7:2005-0
	When connecting the conductor, make sure that the CAPAROC modules are not pulled apart due to tensile force. Gaps must not be created between the modules.

Product properties

Product type	Device circuit breakers
Product family	CAPAROC
Type	Plug-in module
Number of slots	4

Insulation characteristics

Protection class	III
Pollution degree	2

System properties

PROFINET

Device function	PROFINET device
Specification	PROFINET-IO RT/IRT, Spec. 2.x
Conformance Class	Conformance-Class C
Redundancy	MRP (Media Redundancy Protocol)

Electrical properties

General

Operating voltage	10 V DC ... 30 V DC
Rated voltage	12 V DC
	24 V DC
Rated current I_N	45 A DC (Total current input)
Rated surge voltage	0.5 kV
Tripping method	E (electronic)
Feedback resistance	max. 35 V DC
Dielectric strength	35 V DC (Load circuit)
Efficiency	> 99 %
Closed circuit current I_0	typ. 85 mA (no load at 24 V)
Power dissipation	typ. 2 W (no load at 24 V)
	< 3.6 W (at 40 A)
Temperature derating	45 A (Total current at 35°C)
	40 A (Total current at 40°C)

CAPAROC PM PN - Feed-in module



1110986

<https://www.phoenixcontact.com/us/products/1110986>

	15 A (Total current at 50°C)
MTBF (IEC 61709, SN 29500)	3985174.15 h (at 25 °C with 21 % load)
	1760834.9 h (at 40°C with 34.25% load)
	601892.76 h (at 35 °C with 100 % load)
Voltage drop	0.048 V (at 40 A)

Load circuit

Undervoltage switch-off	≤ 9.2 V DC (active)
	≥ 10.2 V DC (inactive)
Overvoltage switch-off	≥ 30.5 V DC (active)
	≤ 29.5 V DC (inactive)

Connection data

Main circuit IN+

Connection method	Push-in connection
Stripping length	18 mm
Conductor cross-section AWG	20 ... 8
Conductor cross-section, flexible, with ferrule, with plastic sleeve	0.5 mm ² ... 16 mm ²
Conductor cross-section flexible, with ferrule without plastic sleeve	0.5 mm ² ... 16 mm ²

Main circuit IN-

Connection method	Push-in connection
Stripping length	18 mm
Conductor cross-section AWG	20 ... 8
Conductor cross-section, flexible, with ferrule, with plastic sleeve	0.5 mm ² ... 16 mm ²
Conductor cross-section flexible, with ferrule without plastic sleeve	0.5 mm ² ... 16 mm ²

System communication

Connection method	Push-in connection
Stripping length	8 mm
Conductor cross-section rigid	0.2 mm ² ... 1.5 mm ²
Conductor cross-section AWG	24 ... 16
Conductor cross-section, flexible, with ferrule, with plastic sleeve	0.2 mm ² ... 0.75 mm ²
Conductor cross-section flexible, with ferrule without plastic sleeve	0.2 mm ² ... 1.5 mm ²

Interfaces

PROFINET

Maximum system extension	≤ 16 (CAPAROC modules alignable)
Protocols supported	PROFINET

Signaling

Connection X1 LED green	lit (connect)
Connection X1 LED yellow	lit (traffic)

CAPAROC PM PN - Feed-in module



1110986

<https://www.phoenixcontact.com/us/products/1110986>

Connection X2 LED green	lit (connect)
Connection X2 LED yellow	lit (traffic)
PROFINET bus fault (BF) LED red	lit (connection status not available)
	flashing (connection status OK, no communication connection to PROFINET controller)
	off (active communication connection to PROFINET controller)
PROFINET group error (SF) LED red	lit (PROFINET error)
	off (no PROFINET error)
PROFINET ready (RDY) LED green	lit (correct operation)
	flashing (waiting for application startup)
	off (operation not correct)
Power (PWR) LED green	lit (Supply voltage)
Power (PWR) LED red	lit (Supply voltage outside the nominal range)

Dimensions

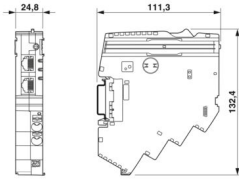
Dimensional drawing	
Width	24.8 mm
Height	132.4 mm
Depth	111.3 mm (incl. DIN rail 7.5 mm)

Material specifications

Color	light gray (RAL 7035)
Material	PA 6
	PA 6
	PA 6
	PC
Flammability rating according to UL 94	V-0

Environmental and real-life conditions

Ambient conditions

Degree of protection	IP20
Ambient temperature (operation)	-30 °C ... 50 °C
Ambient temperature (storage/transport)	-40 °C ... 70 °C
Altitude	≤ 4000 m (amsl)
Humidity test	96 h, 95 % RH, 40 °C
Shock (operation)	30g (11 ms period, half-sine shock pulse, according to IEC 60068-2-27)
	25g (6 ms duration, half-sine shock pulse in accordance with IEC 60068-2-27, continuous shock)

CAPAROC PM PN - Feed-in module



1110986

<https://www.phoenixcontact.com/us/products/1110986>

Vibration (operation)	5g (10 Hz ... 150 Hz / 10 cycles / axis / X, Y, Z)
-----------------------	--

Approvals

UL approval

Identification	UL/C-UL Listed UL 508
	UL 121201 Class I, Division 2, Groups A, B, C, D, T4A

Corrosive gas test

Identification	ISA S71.04.2013 G3 Harsh Group A
----------------	----------------------------------

Standards and regulations

Standards/specifications	EN 61000-6-2
Note	EMC – Immunity for industrial areas
Standards/specifications	EN 61000-6-3
Note	EMC – Emission for residential, business and commercial properties and small operations
Standards/specifications	EN 60068-2-78
Note	Environmental influences – Moisture and heat, constant
Standards/specifications	EN 50178
Note	Equipping power installations with electronic equipment
Standards/specifications	EN 60068-2-6
Note	Environmental influences – Vibrations (sinusoidal)
Standards/specifications	EN 60068-2-27
Note	Environmental influences – Shocks

Mounting

Mounting type	pluggable onto CAPAROC CR... current rail
---------------	---

CAPAROC PM PN - Feed-in module



1110986

<https://www.phoenixcontact.com/us/products/1110986>

Drawings

Dimensional drawing

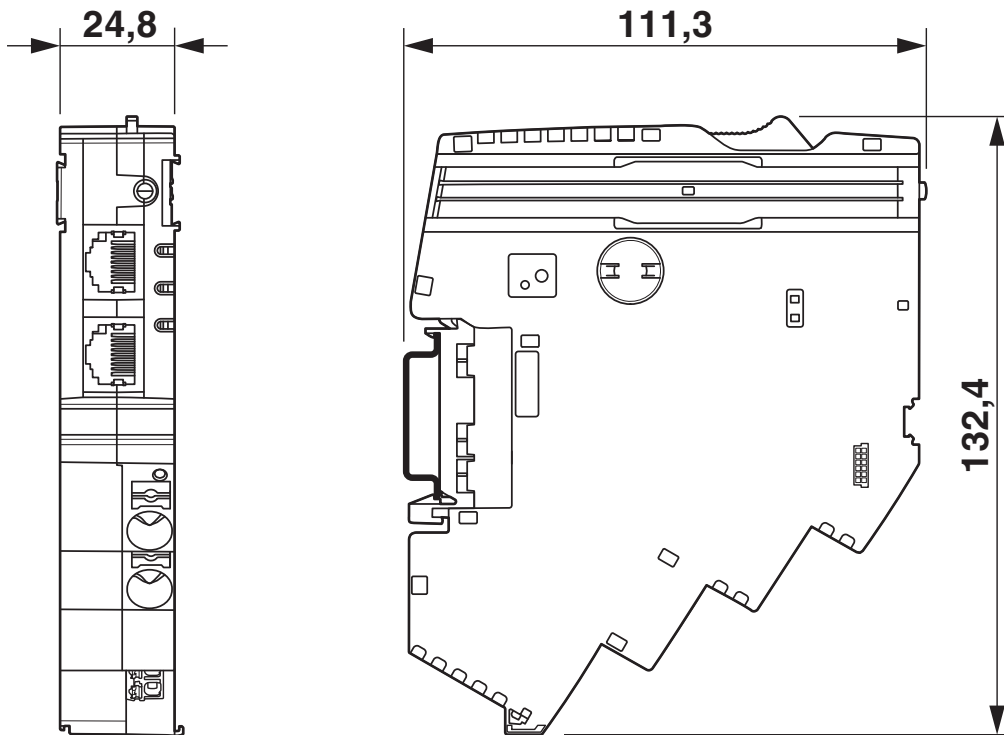

CAPAROC PM PN - Feed-in module

1110986

<https://www.phoenixcontact.com/us/products/1110986>



Product drawing

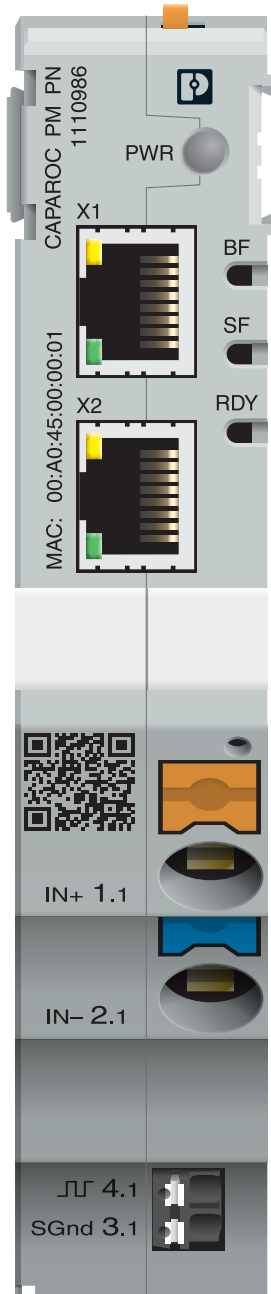

CAPAROC PM PN - Feed-in module

1110986

<https://www.phoenixcontact.com/us/products/1110986>

Schematic diagram

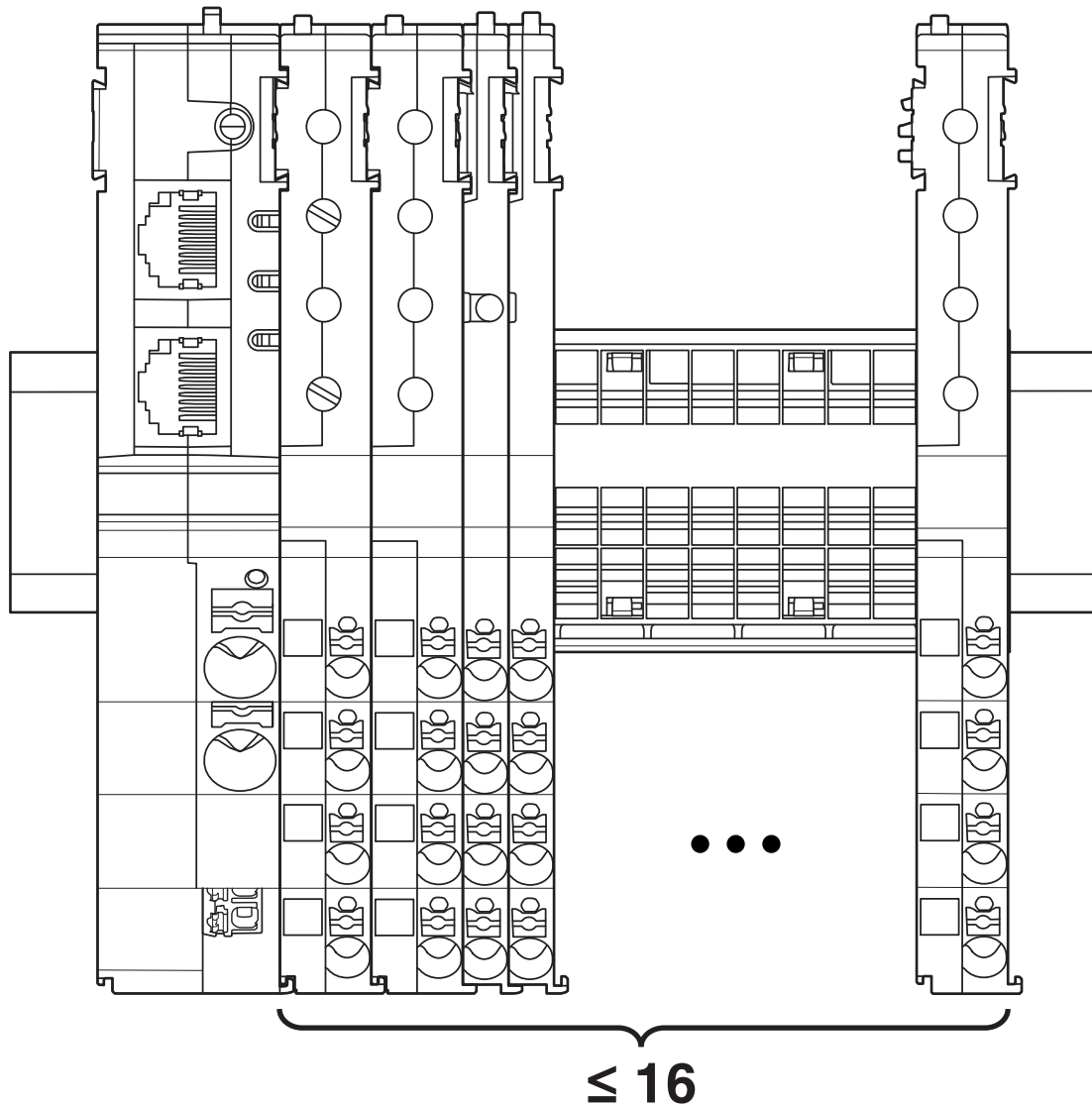

When using the power module with a PROFINET interface (CAPAROC PM PN), max. 16 circuit breaker modules can be set. Any number of extra potential distribution modules can be added.

1110986

<https://www.phoenixcontact.com/us/products/1110986>

Diagram

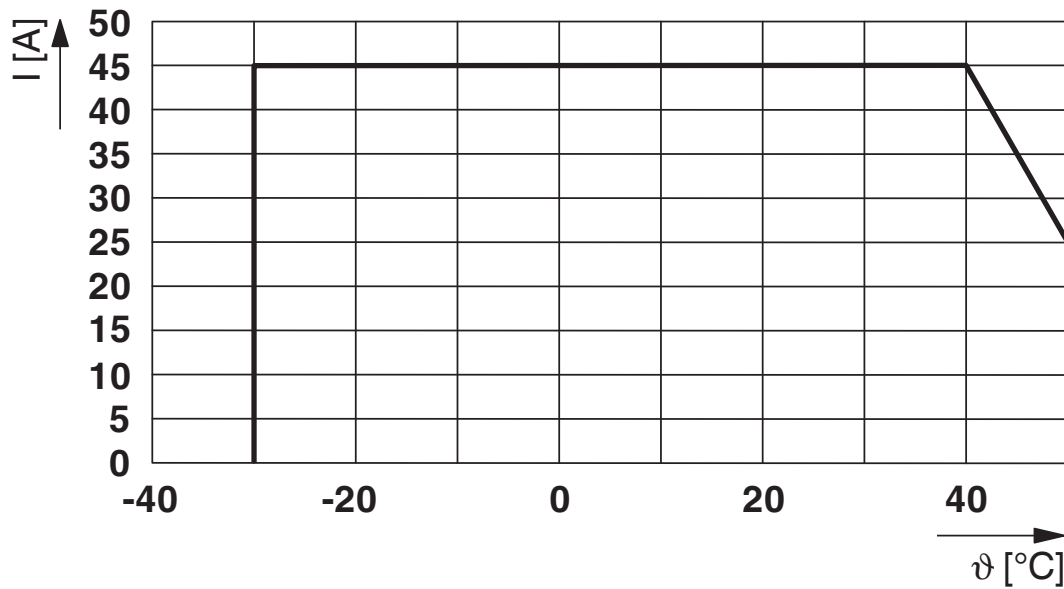

Max. permissible current depending on the ambient temperature for continuous loads with ≤ 8 A per channel

Diagram

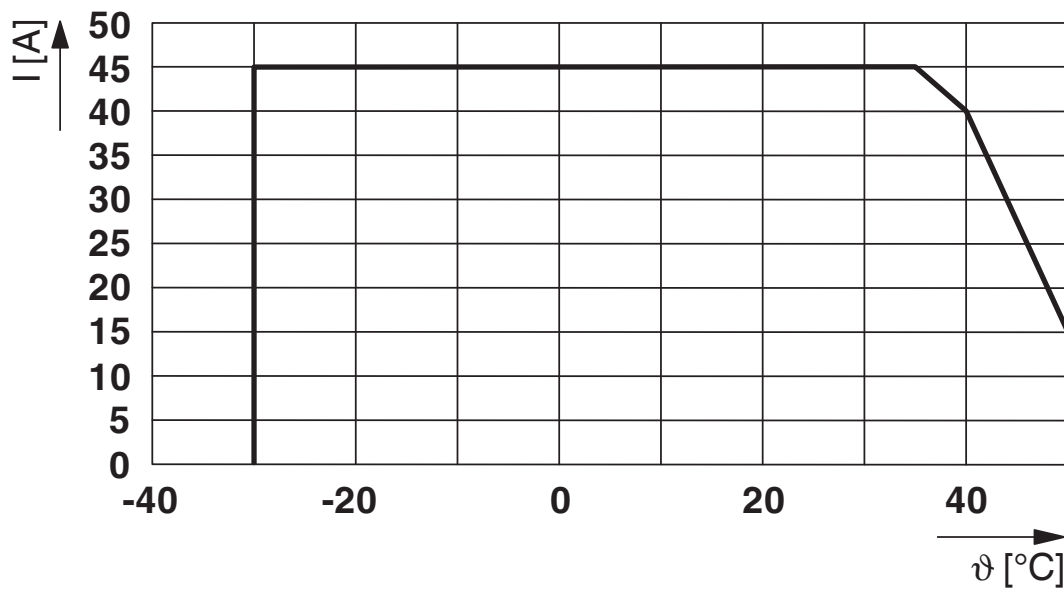

Max. permissible current depending on the ambient temperature for continuous loads > 8 A per channel

CAPAROC PM PN - Feed-in module



1110986

<https://www.phoenixcontact.com/us/products/1110986>

Block diagram

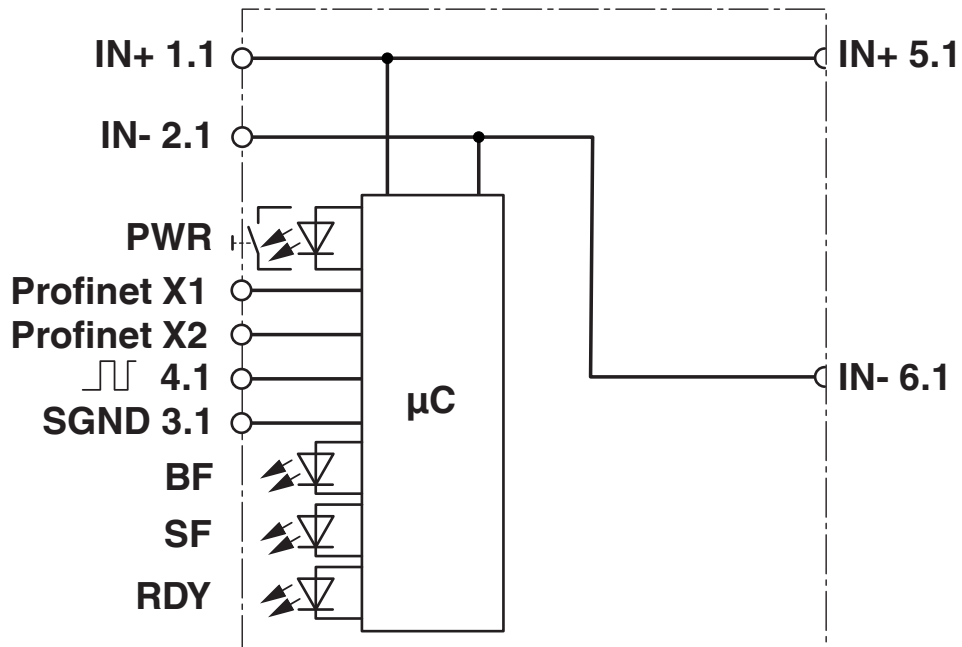

CAPAROC PM PN - Feed-in module





1110986

<https://www.phoenixcontact.com/us/products/1110986>

Approvals

To download certificates, visit the product detail page: <https://www.phoenixcontact.com/us/products/1110986>

 **UL Listed**
Approval ID: E123528

 **cUL Listed**
Approval ID: E123528

PROFINET
Approval ID: Z12936

 **cUL Listed**
Approval ID: FILE E 483407

 **UL Listed**
Approval ID: FILE E 483407

CAPAROC PM PN - Feed-in module



1110986

<https://www.phoenixcontact.com/us/products/1110986>

Classifications

ECLASS

ECLASS-13.0	27140401
ECLASS-15.0	27140401

ETIM

ETIM 9.0	EC003538
----------	----------

UNSPSC

UNSPSC 21.0	39121400
-------------	----------

1110986

<https://www.phoenixcontact.com/us/products/1110986>

Environmental product compliance

EU RoHS

Fulfills EU RoHS substance requirements	Yes
Exemption	7(a), 7(c)-I

China RoHS

Environment friendly use period (EFUP)	EFUP-50
	An article-related China RoHS declaration table can be found in the download area for the respective article under "Manufacturer declaration". For all articles with EFUP-E, no China RoHS declaration table issued and required.

EU REACH SVHC

REACH candidate substance (CAS No.)	Lead(CAS: 7439-92-1)
	2,2',6,6'-tetrabromo-4,4'-isopropylidenediphenol(CAS: 79-94-7)
SCIP	843551a5-9d5e-464d-ad84-78f3ac8a869a

Phoenix Contact 2025 © - all rights reserved
<https://www.phoenixcontact.com>

Phoenix Contact USA
586 Fulling Mill Road
Middletown, PA 17057, United States
(+717) 944-1300
info@phoenixcon.com