

Printed-circuit board connector - BCH-508VS- 7 GN - 5441922

Please be informed that the data shown in this PDF Document is generated from our Online Catalog. Please find the complete data in the user's documentation. Our General Terms of Use for Downloads are valid (<http://phoenixcontact.com/download>)



PCB headers, nominal current: 12 A, rated voltage (III/2): 320 V, nominal cross section: 2.5 mm², number of positions: 7, pitch: 5.08 mm, color: pastel green, contact surface: Tin, mounting: Wave soldering, pin layout: Linear pinning, solder pin [P]: 3.9 mm

The figure shows a 5-pos. version of the product in gray

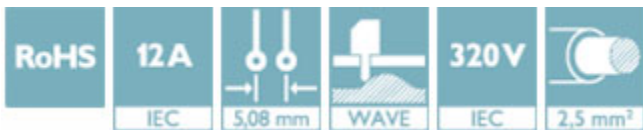

Key Commercial Data

Packing unit	1 pc
Minimum order quantity	100 pc
GTIN	 4 046356 643740
GTIN	4046356643740
Weight per Piece (excluding packing)	2.800 g
Custom tariff number	85366930
Country of origin	China

Technical data

Dimensions

Length [l]	8.6 mm
Width	17.24 mm
Pitch	5.08 mm
Dimension a	30.48 mm
Width [w]	17.24 mm
Height [h]	15.9 mm
Height	12 mm
Length of the solder pin	3.9 mm
Pin dimensions	1 x 1 mm

Printed-circuit board connector - BCH-508VS- 7 GN - 5441922

Technical data

Dimensions

Length	8.6 mm
--------	--------

General

Range of articles	BCH-VS
Insulating material group	I
Rated surge voltage (III/3)	4 kV
Rated surge voltage (III/2)	4 kV
Rated surge voltage (II/2)	4 kV
Rated voltage (III/3)	250 V
Rated voltage (III/2)	320 V
Rated voltage (II/2)	400 V
Connection in acc. with standard	EN-VDE
Nominal current I_N	12 A
Maximum load current	12 A
Insulating material	PA
Flammability rating according to UL 94	V0
Color	pastel green
Number of positions	7

Standards and Regulations

Connection in acc. with standard	EN-VDE
	CUL
Flammability rating according to UL 94	V0

Environmental Product Compliance

China RoHS	Environmentally friendly use period: unlimited = EFUP-e
	No hazardous substances above threshold values

Drawings

Printed-circuit board connector - BCH-508VS- 7 GN - 5441922

Drilling diagram

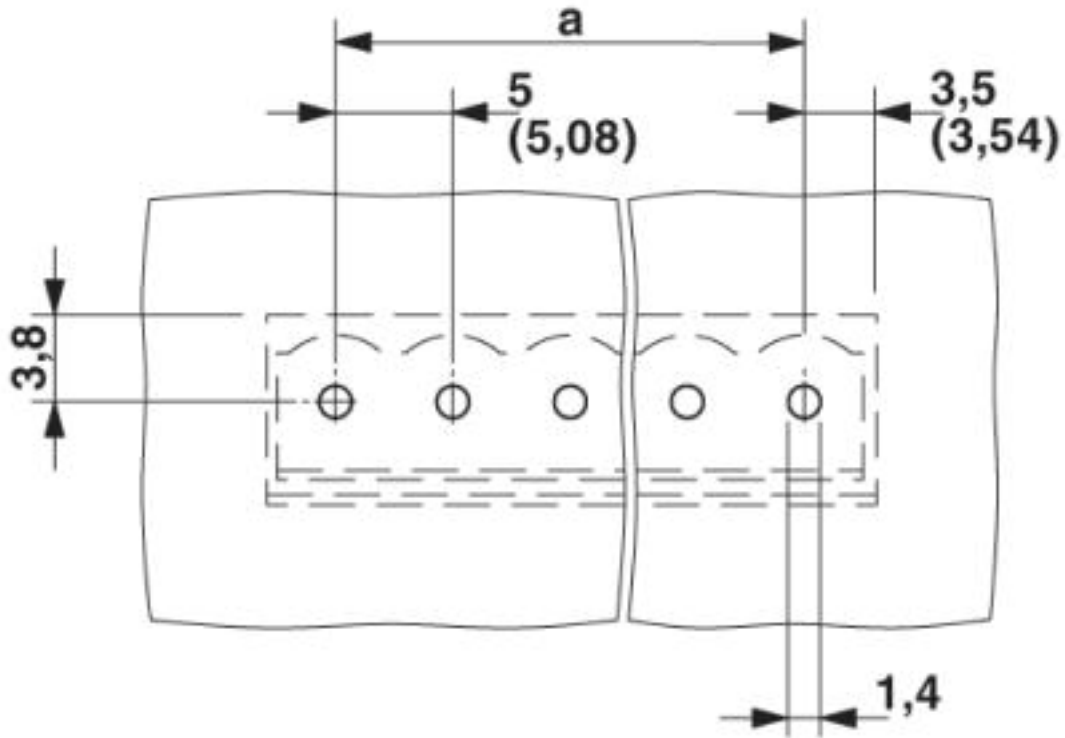

Dimensional drawing

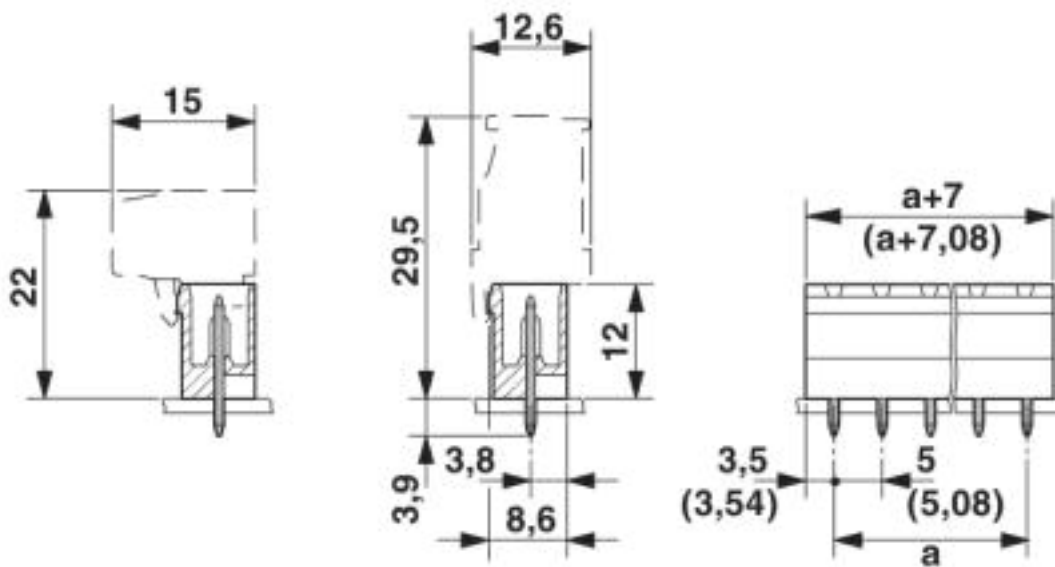

Printed-circuit board connector - BCH-508VS- 7 GN - 5441922

Classifications

eCl@ss

eCl@ss 10.0.1	27440402
eCl@ss 4.0	27260700
eCl@ss 4.1	27260700
eCl@ss 5.0	27260700
eCl@ss 5.1	27260700
eCl@ss 6.0	27260700
eCl@ss 7.0	27440402
eCl@ss 8.0	27440402
eCl@ss 9.0	27440402

ETIM

ETIM 3.0	EC001121
ETIM 4.0	EC002498
ETIM 5.0	EC002637
ETIM 6.0	EC002637
ETIM 7.0	EC002637

UNSPSC

UNSPSC 6.01	30211801
UNSPSC 7.0901	39121432
UNSPSC 11	39121432
UNSPSC 12.01	39121409
UNSPSC 13.2	39121409
UNSPSC 18.0	39121409
UNSPSC 19.0	39121409
UNSPSC 20.0	39121409
UNSPSC 21.0	39121409

Approvals

Approvals

Approvals

IECEE CB Scheme / VDE Gutachten mit Fertigungsüberwachung / cULus Recognized / EAC

Ex Approvals

Printed-circuit board connector - BCH-508VS- 7 GN - 5441922

Approvals

Approval details

IECEE CB Scheme		http://www.iecee.org/	DE1-58974
-----------------	--	---	-----------

VDE Gutachten mit Fertigungsüberwachung		http://www2.vde.com/de/Institut/Online-Service/VDE-gepruefteProdukte/Seiten/Online-Suche.aspx	40040694
Nominal voltage UN	320 V		
Nominal current IN	12 A		
mm ² /AWG/kcmil	0.2-2.5		

cULus Recognized		http://database.ul.com/cgi-bin/XYV/template/LISEXT/1FRAME/index.htm	E60425-20071007
	B	D	
Nominal voltage UN	300 V	150 V	
Nominal current IN	15 A	15 A	

EAC		B.01687
-----	--	---------

Accessories

Accessories

Coding element

Coding section - CR-BC-M - 5436157

Coding section



Filler plug

Printed-circuit board connector - BCH-508VS- 7 GN - 5441922

Accessories

Accessories - MSTB-BL - 1755477



Keying cap, for forming sections, plugs onto header pin, green insulating material

Labeled terminal marker

Marker card - SK 5/3,8:FORTL.ZAHLEN - 0804183



Marker card, Card, white, labeled, Horizontal: consecutive numbers 1 ... 10, 11 ... 20, etc. up to 91 ... (99)100, mounting type: adhesive, for terminal block width: 5 mm, lettering field size: 5 x 3.8 mm

Terminal marking

Marker card - SK U/3,8 WH:UNBEDRUCKT - 0803906



Marker card, Sheet, white, unlabeled, can be labeled with: PLOTMARK, CMS-P1-PLOTTER, Office printing systems, mounting type: adhesive, for terminal block width: 210 mm, lettering field size: 186 x 3.8 mm, Number of individual labels: 1440