

Printed-circuit board connector - SPC 5/ 4-STF-7,62 - 1996142

Please be informed that the data shown in this PDF Document is generated from our Online Catalog. Please find the complete data in the user's documentation. Our General Terms of Use for Downloads are valid (<http://phoenixcontact.com/download>)

PCB connector, nominal current: 41 A, number of positions: 4, pitch: 7.62 mm, connection method: Push-in spring connection, color: green, contact surface: Tin



The figure shows a 5-pos. version of the product

Your advantages

- ✓ Time saving push-in connection, tools not required
- ✓ Defined contact force ensures that contact remains stable over the long term
- ✓ Clamping space opened by means of fixed screwdriver enables convenient conductor connection
- ✓ Integrated double steel spring provides additional safety in the event of temperature and power fluctuations
- ✓ Optimized for tight installation situations: operation and conductor connection from one direction
- ✓ Screwable flange for superior mechanical stability
- ✓ 600 V UL approval in the smallest of dimensions



Key Commercial Data

Packing unit	1 pc
Minimum order quantity	50 pc
GTIN	 4 046356 037884
GTIN	4046356037884
Weight per Piece (excluding packing)	23.430 g
Custom tariff number	85366990
Country of origin	India

Technical data

Dimensions

Length [l]	38.5 mm
--------------	---------

Printed-circuit board connector - SPC 5/ 4-STF-7,62 - 1996142

Technical data

Dimensions

Width [w]	45.7 mm
Height [h]	19.8 mm
Pitch	7.62 mm
Dimension a	22.86 mm

General

Range of articles	SPC 5/...-STF
Number of positions	4
Connection method	Push-in spring connection
Insulating material group	I
Rated surge voltage (III/3)	8 kV
Rated surge voltage (III/2)	8 kV
Rated surge voltage (II/2)	6 kV
Rated voltage (III/3)	1000 V
Rated voltage (III/2)	1000 V
Rated voltage (II/2)	1000 V
Connection in acc. with standard	EN-VDE
Nominal current I_N	41 A
Nominal cross section	6 mm ²
Maximum load current	41 A
Insulating material	PA
Flammability rating according to UL 94	V0
Stripping length	15 mm

Connection data

Conductor cross section solid min.	0.2 mm ²
Conductor cross section solid max.	10 mm ²
Conductor cross section flexible min.	0.2 mm ²
Conductor cross section flexible max.	6 mm ²
Conductor cross section flexible, with ferrule without plastic sleeve min.	0.25 mm ²
Conductor cross section flexible, with ferrule without plastic sleeve max.	6 mm ²
Conductor cross section flexible, with ferrule with plastic sleeve min.	0.25 mm ²
Conductor cross section flexible, with ferrule with plastic sleeve max.	4 mm ²
Conductor cross section AWG min.	24
Conductor cross section AWG max.	8
2 conductors with same cross section, stranded, TWIN ferrules with plastic sleeve, min.	0.25 mm ²
2 conductors with same cross section, stranded, TWIN ferrules with plastic sleeve, max.	1.5 mm ²

Printed-circuit board connector - SPC 5/ 4-STF-7,62 - 1996142

Technical data

Connection data

Minimum AWG according to UL/CUL	24
Maximum AWG according to UL/CUL	8

Specifications for ferrules

Recommended crimping pliers	1212034 CRIMPFOX 6
Ferrules without insulating collar, according to DIN 46228-1	Cross section: 0.5 mm ² ; Length: 10 mm ... 15 mm
	Cross section: 0.75 mm ² ; Length: 10 mm ... 15 mm
	Cross section: 1 mm ² ; Length: 10 mm ... 15 mm
	Cross section: 1.5 mm ² ; Length: 10 mm ... 15 mm
	Cross section: 2.5 mm ² ; Length: 12 mm ... 15 mm
	Cross section: 4 mm ² ; Length: 12 mm ... 15 mm

Standards and Regulations

Connection in acc. with standard	EN-VDE
	CUL
Flammability rating according to UL 94	V0

Environmental Product Compliance

China RoHS	Environmentally friendly use period: unlimited = EFUP-e
	No hazardous substances above threshold values

Drawings

Printed-circuit board connector - SPC 5/ 4-STF-7,62 - 1996142

Diagram

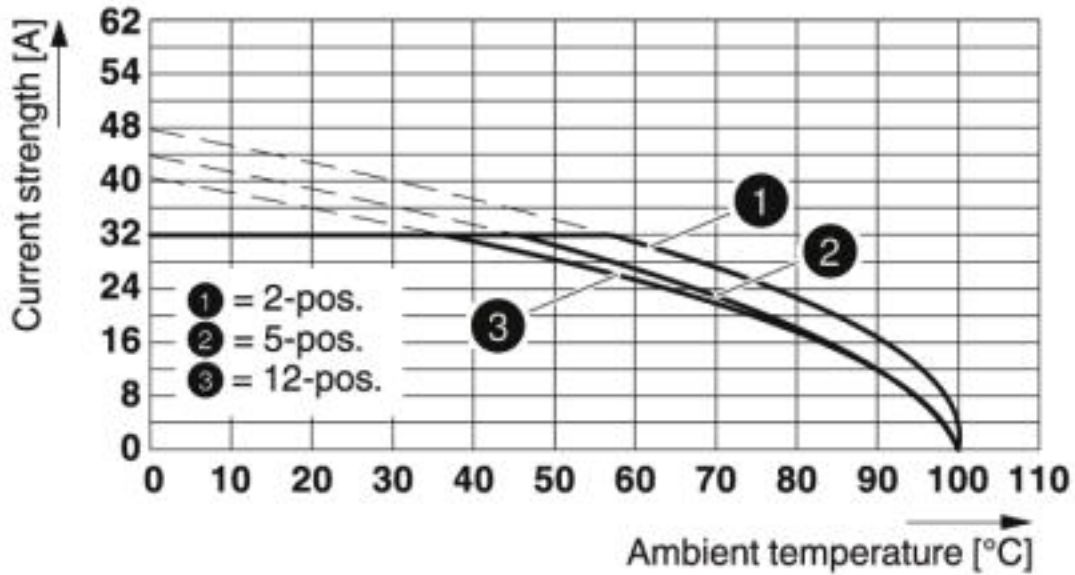

Derating curve for: SPC 5/...-ST-7,62 with PC 5/...-G-7,62

Diagram

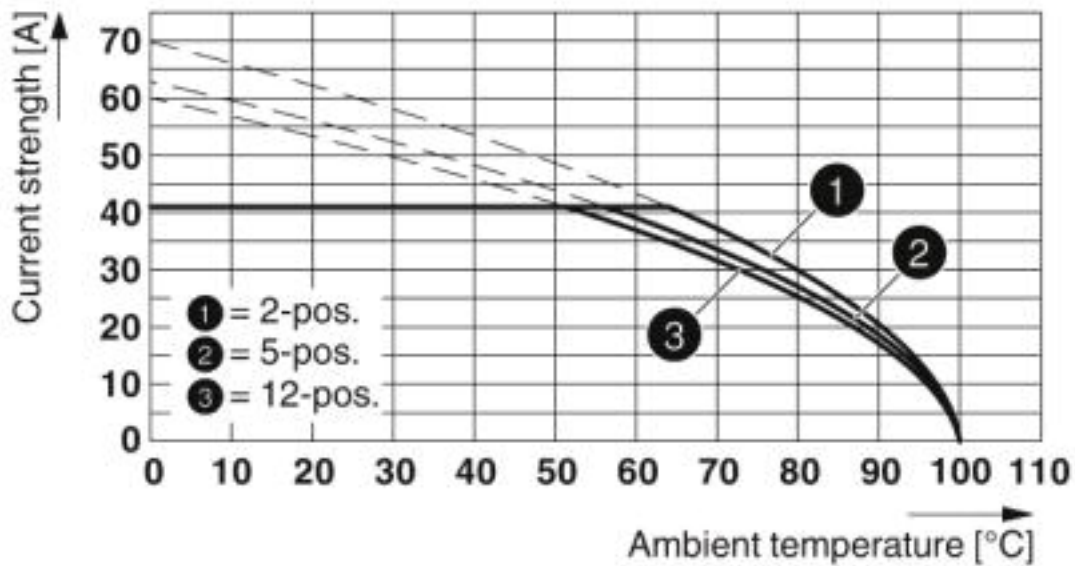

Type: SPC 5/...-STF-7,62 with DFK-PC 5/...-STF-7,62
Conductor cross section: 10 mm²

Printed-circuit board connector - SPC 5/ 4-STF-7,62 - 1996142

Dimensional drawing

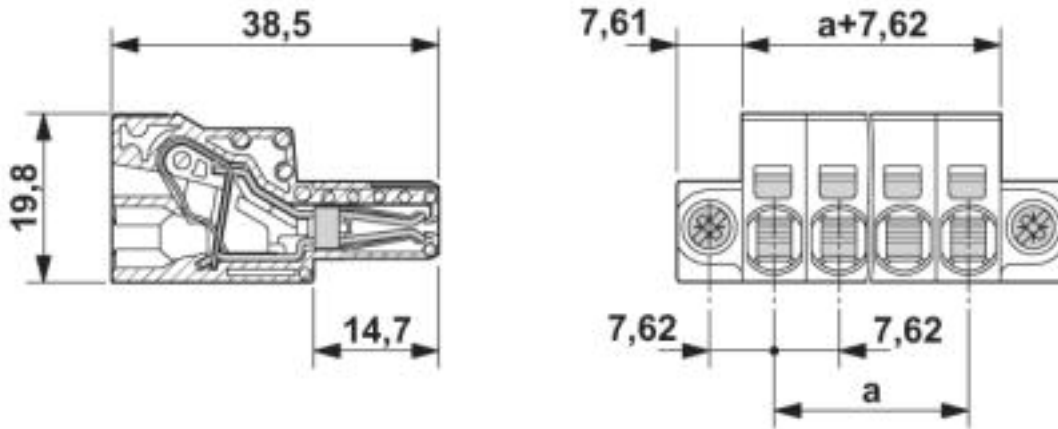

Classifications

eCl@ss

eCl@ss 4.0	27260700
eCl@ss 4.1	27260700
eCl@ss 5.0	27260700
eCl@ss 5.1	27260700
eCl@ss 6.0	27260700
eCl@ss 7.0	27440309
eCl@ss 8.0	27440309
eCl@ss 9.0	27440309

ETIM

ETIM 3.0	EC001121
ETIM 4.0	EC002638
ETIM 5.0	EC002638
ETIM 6.0	EC002638
ETIM 7.0	EC002638

UNSPSC

UNSPSC 6.01	30211810
UNSPSC 7.0901	39121409
UNSPSC 11	39121409
UNSPSC 12.01	39121409
UNSPSC 13.2	39121409

Printed-circuit board connector - SPC 5/ 4-STF-7,62 - 1996142

Approvals

Approvals

Approvals

EAC / cULus Recognized

Ex Approvals

Approval details

EAC		B.01742
-----	--	---------

cULus Recognized		http://database.ul.com/cgi-bin/XYV/template/LISEXT/1FRAME/index.htm	E60425-19920722
	B	C	
Nominal voltage UN	600 V	600 V	
Nominal current IN	35 A	35 A	
mm ² /AWG/kcmil	24-8	24-8	

Accessories

Accessories

Cable end sleeve

Ferrule - AI 4 -15 GY - 1200264



Ferrule, sleeve length: 15 mm, length: 23 mm, color: gray

Coding element

Printed-circuit board connector - SPC 5/ 4-STF-7,62 - 1996142

Accessories

Coding profile - CP-PC RD - 1701967



Coding profile, for plugging into the coding ribs of the plug at a later date, insulating material, color: Red

Crimping tool

Crimping pliers - CRIMPFOX 6 - 1212034



Crimping pliers, for ferrules without insulating collar according to DIN 46228 Part 1 and ferrules with insulating collar according to DIN 46228 Part 4, 0.25 mm² ... 6.0 mm², lateral entry, trapezoidal crimp

Labeled terminal marker

Marker card - SK 7,62/3,8:FORTL.ZAHLEN - 0804549



Marker card, Card, white, labeled, Horizontal: consecutive numbers 1 ... 10, 11 ... 20, etc. up to 91 ... 100, mounting type: adhesive, for terminal block width: 7.62 mm, lettering field size: 7.62 x 3.8 mm

Marker card - SK 3,8 REEL P7,62 WH CUS - 0825128



Marker card, can be ordered: By card, white, labeled according to customer specifications, mounting type: adhesive, for terminal block width: 7.62 mm, lettering field size: continuous x 3.8 mm

Screwdriver tools

Printed-circuit board connector - SPC 5/ 4-STF-7,62 - 1996142

Accessories

Screwdriver - SZF 1-0,6X3,5 - 1204517



Actuation tool, for ST terminal blocks, also suitable for use as a bladed screwdriver, size: 0.6 x 3.5 x 100 mm, 2-component grip, with non-slip grip

Terminal marking

Marker card - SK U/3,8 WH:UNBEDRUCKT - 0803906



Marker card, Sheet, white, unlabeled, can be labeled with: PLOTMARK, CMS-P1-PLOTTER, Office printing systems, mounting type: adhesive, for terminal block width: 210 mm, lettering field size: 186 x 3.8 mm, Number of individual labels: 1440

Marker strip - SK 3,8 WH:REEL - 0805218



Marker strip, Roll, white, unlabeled, can be labeled with: THERMOMARK ROLL 2.0, THERMOMARK ROLL, THERMOMARK ROLL X1, THERMOMARK ROLLMASTER 300/600, THERMOMARK X1.2, mounting type: adhesive, for terminal block width: 90000 mm, lettering field size: continuous x 3.8 mm, Number of individual labels: 210000

Additional products

Printed-circuit board connector - DFK-PC 5/ 4-GF-SH-7,62 - 1716085



Feed-through header, nominal current: 41 A, number of positions: 4, pitch: 7.62 mm, color: green, contact surface: Tin, mounting: Wave soldering

Printed-circuit board connector - DFK-PC 5/ 4-GFU-SH-7,62 - 1716195



Feed-through header, nominal current: 41 A, number of positions: 4, pitch: 7.62 mm, color: green, contact surface: Tin, mounting: Wave soldering

Printed-circuit board connector - SPC 5/ 4-STF-7,62 - 1996142

Accessories

Printed-circuit board connector - DFK-PCV 5/ 4-GF-7,62 - 1716412



Feed-through header, nominal current: 41 A, number of positions: 4, pitch: 7.62 mm, color: green, contact surface: Tin, mounting: Wave soldering

Printed-circuit board connector - PC 5/ 4-GF-7,62 - 1720819



PCB headers, nominal current: 41 A, number of positions: 4, pitch: 7.62 mm, color: green, contact surface: Tin, mounting: Wave soldering

Printed-circuit board connector - PCV 5/ 4-GF-7,62 - 1720929



PCB headers, nominal current: 41 A, number of positions: 4, pitch: 7.62 mm, color: green, contact surface: Tin, mounting: Wave soldering

Printed-circuit board connector - PC 5/ 4-GFU-7,62 - 1721038



PCB headers, nominal current: 41 A, number of positions: 4, pitch: 7.62 mm, color: green, contact surface: Tin, mounting: Wave soldering

Printed-circuit board connector - DFK-PC 5/ 4-GF-7,62 - 1727715



Feed-through header, nominal current: 41 A, number of positions: 4, pitch: 7.62 mm, color: green, contact surface: Tin, mounting: Wave soldering

Printed-circuit board connector - SPC 5/ 4-STF-7,62 - 1996142

Accessories

Printed-circuit board connector - DFK-PC 5/ 4-GFU-7,62 - 1727935



Feed-through header, nominal current: 41 A, number of positions: 4, pitch: 7.62 mm, color: green, contact surface: Tin, mounting: Wave soldering