

PCB terminal block - PTA 1,5/ 6-5,0 - 1988846

Please be informed that the data shown in this PDF Document is generated from our Online Catalog. Please find the complete data in the user's documentation. Our General Terms of Use for Downloads are valid (<http://phoenixcontact.com/download>)

PCB terminal block, nominal current: 17.5 A, pitch: 5 mm, number of positions: 6, connection method: Screw connection with wire protector, mounting: Wave soldering, conductor/PCB connection direction: 45 °, color: green



The figure shows a 10-position version of the product

Your advantages

- ✓ Well-known connection principle allows worldwide use
- ✓ Low temperature rise, thanks to maximum contact force
- ✓ High terminal block capacity thanks to rectangular terminal block space
- ✓ Allows connection of two conductors
- ✓ Angled connection enables multi-row arrangement on the PCB
- ✓ The latching on the side enables various numbers of positions to be combined



Key Commercial Data

Packing unit	1 pc
Minimum order quantity	100 pc
GTIN	 4 046356 036832
GTIN	4046356036832
Weight per Piece (excluding packing)	6.420 g
Custom tariff number	85369010
Country of origin	Greece

Technical data

Dimensions

Length [l]	12.8 mm
Pitch	5 mm

PCB terminal block - PTA 1,5/ 6-5,0 - 1988846

Technical data

Dimensions

Dimension a	25 mm
Width [w]	30 mm
Height	11.9 mm
Height [h]	15.4 mm
Solder pin [P]	3.5 mm
Pin spacing	5 mm
Hole diameter	1.3 mm

General

Range of articles	PTA 1,5
Insulating material group	I
Rated surge voltage (III/3)	4 kV
Rated surge voltage (III/2)	4 kV
Rated surge voltage (II/2)	4 kV
Rated voltage (III/3)	250 V
Rated voltage (III/2)	400 V
Rated voltage (II/2)	630 V
Connection in acc. with standard	EN-VDE
Nominal current I_N	17.5 A
Nominal cross section	1.5 mm ²
Maximum load current	24 A
Insulating material	PA
Flammability rating according to UL 94	V0
Internal cylindrical gage	A1 / B1
Stripping length	5 mm
Number of positions	6
Screw thread	M2,6
Tightening torque, min	0.35 Nm
Tightening torque max	0.4 Nm

Connection data

Conductor cross section solid min.	0.14 mm ²
Conductor cross section solid max.	2.5 mm ²
Conductor cross section flexible min.	0.14 mm ²
Conductor cross section flexible max.	2.5 mm ²
Conductor cross section flexible, with ferrule without plastic sleeve min.	0.25 mm ²
Conductor cross section flexible, with ferrule without plastic sleeve max.	1.5 mm ²
Conductor cross section flexible, with ferrule with plastic sleeve min.	0.25 mm ²

PCB terminal block - PTA 1,5/ 6-5,0 - 1988846

Technical data

Connection data

Conductor cross section flexible, with ferrule with plastic sleeve max.	1.5 mm ²
Conductor cross section AWG min.	26
Conductor cross section AWG max.	14
2 conductors with same cross section, solid min.	0.14 mm ²
2 conductors with same cross section, solid max.	1 mm ²
2 conductors with same cross section, stranded min.	0.14 mm ²
2 conductors with same cross section, stranded max.	0.75 mm ²
2 conductors with same cross section, stranded, ferrules without plastic sleeve, min.	0.25 mm ²
2 conductors with same cross section, stranded, ferrules without plastic sleeve, max.	0.34 mm ²
2 conductors with same cross section, stranded, TWIN ferrules with plastic sleeve, min.	0.25 mm ²
2 conductors with same cross section, stranded, TWIN ferrules with plastic sleeve, max.	0.75 mm ²

Standards and Regulations

Connection in acc. with standard	EN-VDE
	CUL
Flammability rating according to UL 94	V0

Environmental Product Compliance

	Lead 7439-92-1
China RoHS	Environmentally Friendly Use Period = 50
	For details about hazardous substances go to tab "Downloads", Category "Manufacturer's declaration"

Drawings

PCB terminal block - PTA 1,5/ 6-5,0 - 1988846

Drilling diagram

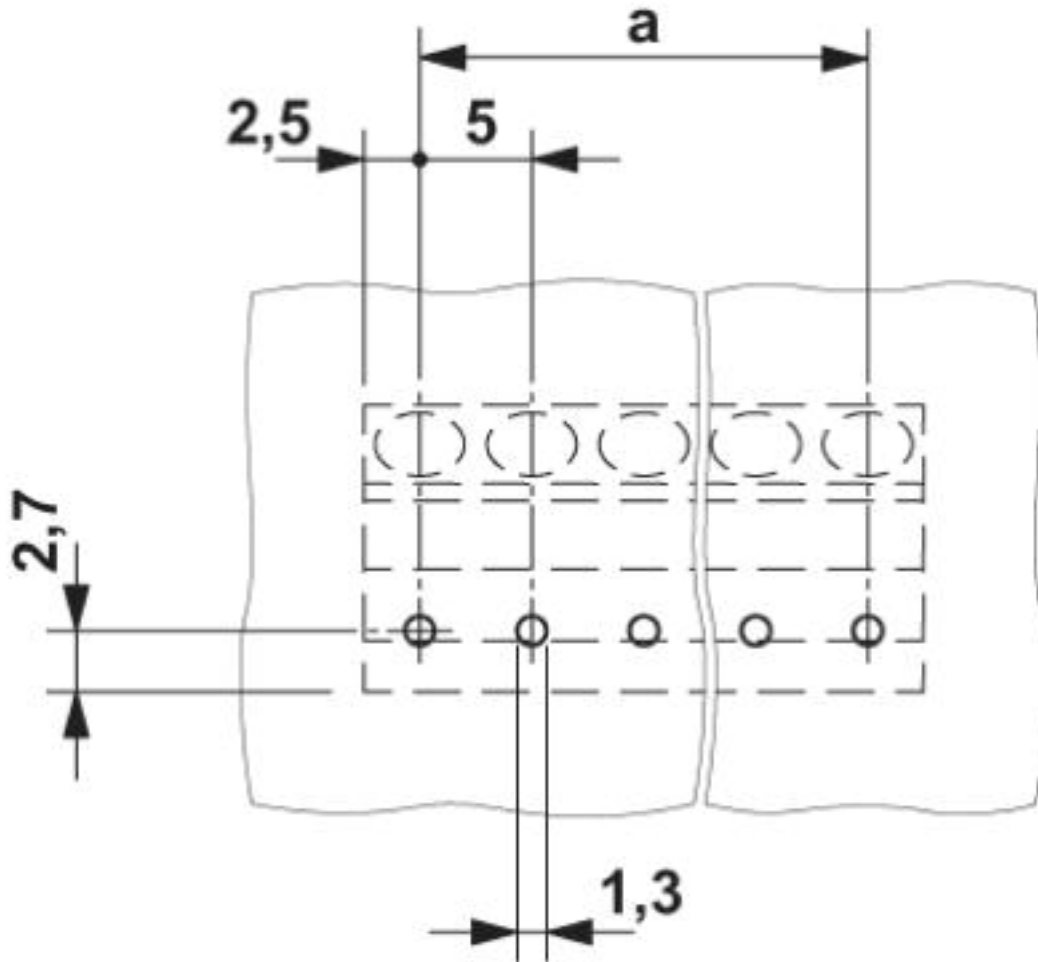

PCB terminal block - PTA 1,5/ 6-5,0 - 1988846

Diagram

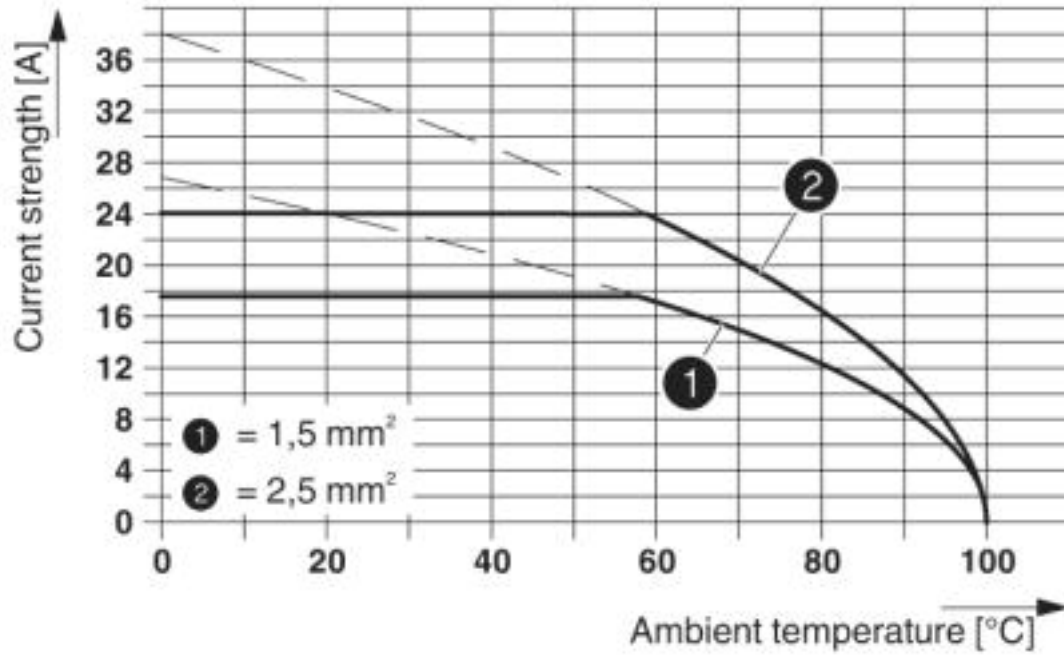

PCB terminal block - PTA 1,5/ 6-5,0 - 1988846

Dimensional drawing

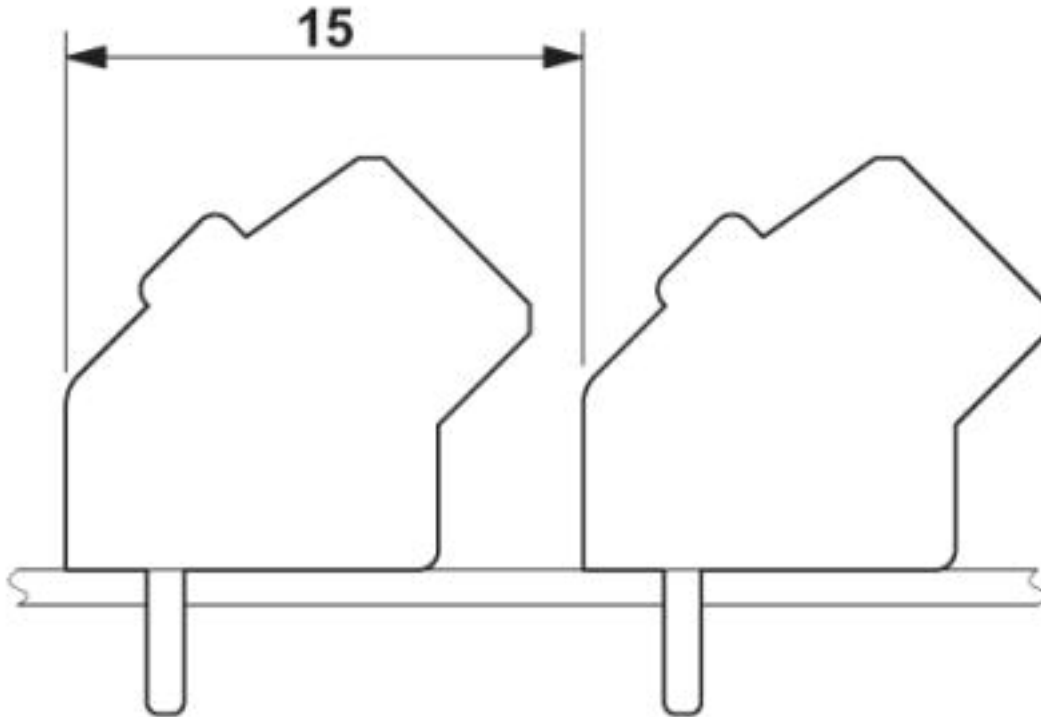

Dimensional drawing

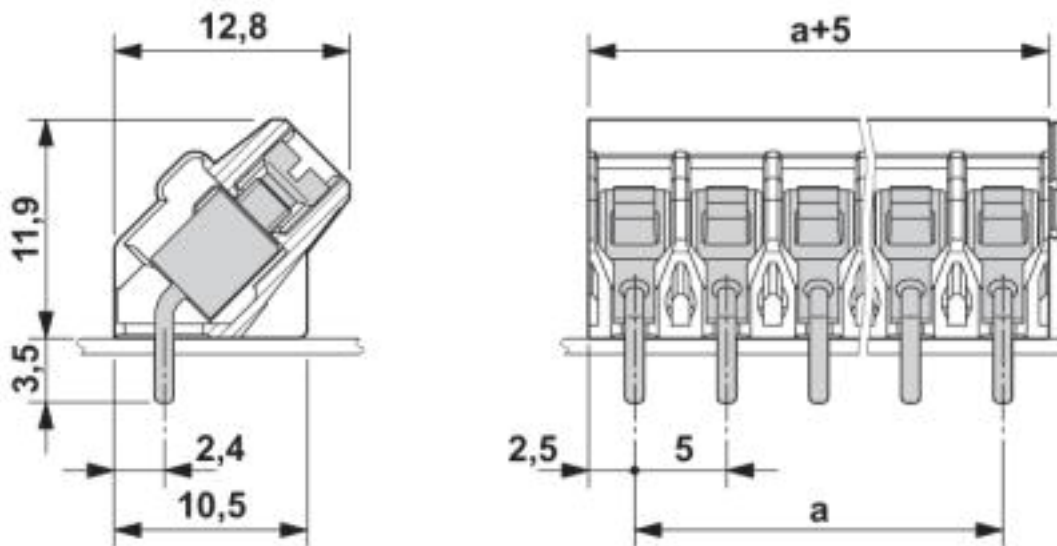

PCB terminal block - PTA 1,5/ 6-5,0 - 1988846

Classifications

eCl@ss

eCl@ss 4.0	27260700
eCl@ss 4.1	27141100
eCl@ss 5.0	27141100
eCl@ss 5.1	27261100
eCl@ss 6.0	27261100
eCl@ss 7.0	27440401
eCl@ss 8.0	27440401
eCl@ss 9.0	27440401

ETIM

ETIM 3.0	EC001121
ETIM 4.0	EC002643
ETIM 5.0	EC002643
ETIM 6.0	EC002643
ETIM 7.0	EC002643

UNSPSC

UNSPSC 6.01	30211801
UNSPSC 7.0901	39121432
UNSPSC 11	34131203
UNSPSC 12.01	39121432
UNSPSC 13.2	39121432

Approvals

Approvals

Approvals

IECEE CB Scheme / VDE Gutachten mit Fertigungsüberwachung / EAC / cULus Recognized / CCA

Ex Approvals

Approval details

PCB terminal block - PTA 1,5/ 6-5,0 - 1988846

Approvals

IECEE CB Scheme		http://www.iecee.org/	DE1-61760
Nominal voltage UN	250 V		
Nominal current IN	24 A		
mm ² /AWG/kcmil	0.2-2.5		

VDE Gutachten mit Fertigungsüberwachung		http://www2.vde.com/de/Institut/Online-Service/VDE-gepruefteProdukte/Seiten/Online-Suche.aspx	40031691
Nominal voltage UN	250 V		
Nominal current IN	24 A		
mm ² /AWG/kcmil	0.2-2.5		

EAC		B.01742
-----	---	---------

cULus Recognized		http://database.ul.com/cgi-bin/XYV/template/LISEXT/1FRAME/index.htm	E60425-20030211
	B	D	
Nominal voltage UN	300 V	300 V	
Nominal current IN	15 A	10 A	
mm ² /AWG/kcmil	26-12	26-12	

CCA	CCA/DE1 34714
Nominal voltage UN	250 V
Nominal current IN	24 A
mm ² /AWG/kcmil	0.2-2.5

Accessories

Accessories

Labeled terminal marker

PCB terminal block - PTA 1,5/ 6-5,0 - 1988846

Accessories

Marker card - SK 5/3,8:FORTL.ZAHLEN - 0804183



Marker card, Card, white, labeled, Horizontal: consecutive numbers 1 ... 10, 11 ... 20, etc. up to 91 ... (99)100, mounting type: adhesive, for terminal block width: 5 mm, lettering field size: 5 x 3.8 mm

Screwdriver tools

Screwdriver - SZS 0,6X3,5 - 1205053



Actuation tool, for ST terminal blocks, insulated, also suitable for use as a bladed screwdriver, size: 0.6 x 3.5 x 100 mm, 2-component grip, with non-slip grip