

Printed-circuit board connector - FK-MCP 1,5/ 3-STF-3,5 - 1940101

Please be informed that the data shown in this PDF Document is generated from our Online Catalog. Please find the complete data in the user's documentation. Our General Terms of Use for Downloads are valid (<http://phoenixcontact.com/download>)

Plug component, nominal current: 8 A, rated voltage (III/2): 160 V, number of positions: 3, pitch: 3.5 mm, connection method: Push-in spring connection, color: green, contact surface: Tin

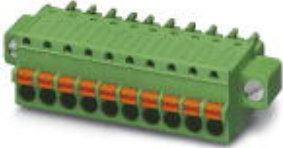

The figure shows a 10-position version of the product

Why buy this product

- ✓ Time saving push-in connection, tools not required
- ✓ Defined contact force ensures that contact remains stable over the long term
- ✓ Intuitive use through colour coded actuation lever
- ✓ Screwable flange for superior mechanical stability
- ✓ Quick and convenient testing using integrated test option

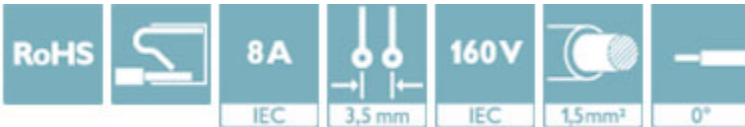

Key Commercial Data

Packing unit	1 STK
Minimum order quantity	50 STK
GTIN	 4 017918 889425
GTIN	4017918889425
Weight per Piece (excluding packing)	3.840 g
Custom tariff number	85366990
Country of origin	Germany

Technical data

Dimensions

Length [l]	20.8 mm
Width [w]	20.8 mm
Height [h]	12.4 mm

Printed-circuit board connector - FK-MCP 1,5/ 3-STF-3,5 - 1940101

Technical data

Dimensions

Pitch	3.5 mm
Dimension a	7 mm

General

Range of articles	FK-MCP 1,5/...STF
Type of contact	Female connector
Number of positions	3
Connection method	Push-in spring connection
Insulating material group	I
Rated surge voltage (III/3)	2.5 kV
Rated surge voltage (III/2)	2.5 kV
Rated surge voltage (II/2)	2.5 kV
Rated voltage (III/3)	160 V
Rated voltage (III/2)	160 V
Rated voltage (II/2)	320 V
Connection in acc. with standard	EN-VDE
Nominal current I_N	8 A
Nominal cross section	1.5 mm ²
Maximum load current	8 A (with 1.5 mm ² conductor cross section)
Insulating material	PA
Flammability rating according to UL 94	V0
Internal cylindrical gage	A1
Stripping length	9 mm

Connection data

Conductor cross section solid min.	0.14 mm ²
Conductor cross section solid max.	1.5 mm ²
Conductor cross section flexible min.	0.14 mm ²
Conductor cross section flexible max.	1.5 mm ²
Conductor cross section flexible, with ferrule without plastic sleeve min.	0.25 mm ²
Conductor cross section flexible, with ferrule without plastic sleeve max.	1.5 mm ²
Conductor cross section flexible, with ferrule with plastic sleeve min.	0.25 mm ²
Conductor cross section flexible, with ferrule with plastic sleeve max.	0.5 mm ²
Conductor cross section AWG min.	26
Conductor cross section AWG max.	16
Minimum AWG according to UL/CUL	28
Maximum AWG according to UL/CUL	16

Standards and Regulations

Printed-circuit board connector - FK-MCP 1,5/ 3-STF-3,5 - 1940101

Technical data

Standards and Regulations

Connection in acc. with standard	EN-VDE
	CUL
Flammability rating according to UL 94	V0

Environmental Product Compliance

China RoHS	Environmentally friendly use period: unlimited = EFUP-e
	No hazardous substances above threshold values

Drawings

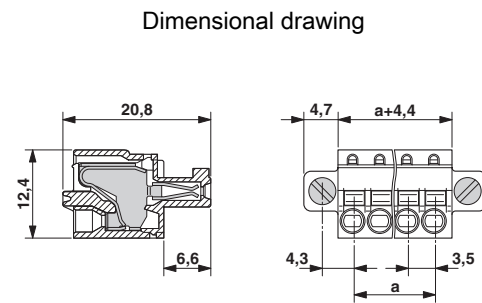
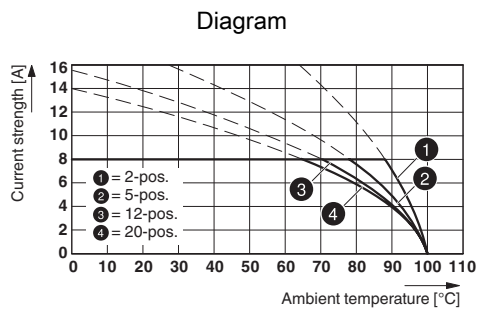

Type: FK-MCP 1,5/...-STF-3,5 with MC 1,5/...-GF-3,5

Classifications

eCl@ss

eCl@ss 4.0	272607xx
eCl@ss 4.1	27260701
eCl@ss 5.0	27260701
eCl@ss 5.1	27260701
eCl@ss 6.0	27260704
eCl@ss 7.0	27440402
eCl@ss 8.0	27440309
eCl@ss 9.0	27440309

ETIM

ETIM 3.0	EC001121
ETIM 4.0	EC002638
ETIM 5.0	EC002638
ETIM 6.0	EC002638

Printed-circuit board connector - FK-MCP 1,5/ 3-STF-3,5 - 1940101

Classifications

UNSPSC

UNSPSC 6.01	30211810
UNSPSC 7.0901	39121409
UNSPSC 11	39121409
UNSPSC 12.01	39121409
UNSPSC 13.2	39121409

Approvals

Approvals

Approvals

VDE Gutachten mit Fertigungsüberwachung / IECCE CB Scheme / CCA / cULus Recognized / EAC

Ex Approvals

Approval details

VDE Gutachten mit Fertigungsüberwachung		http://www.vde.com/en/Institute/OnlineService/VDE-approved-products/Pages/Online-Search.aspx	40011723
mm ² /AWG/kcmil	0.2-1.5		
Nominal current IN	8 A		
Nominal voltage UN	160 V		

IECEE CB Scheme		http://www.iecee.org/	DE1-59621-B1B2
mm ² /AWG/kcmil	0.2-1.5		
Nominal current IN	8 A		
Nominal voltage UN	160 V		

CCA	CCA/ DE1 34219		
mm ² /AWG/kcmil	0.2-1.5		

Printed-circuit board connector - FK-MCP 1,5/ 3-STF-3,5 - 1940101

Approvals

Nominal current I _N	8 A
Nominal voltage U _N	160 V

cULus Recognized		http://database.ul.com/cgi-bin/XYV/template/LISEXT/1FRAME/index.htm	E60425-19920306
		B	
mm ² /AWG/kcmil		28-16	
Nominal current I _N		8 A	
Nominal voltage U _N		300 V	

EAC		B.01742
-----	--	---------

Accessories

Accessories

Crimping tool

Crimping pliers - CRIMPFOX 6 - 1212034



Crimping pliers, for ferrules without insulating collar according to DIN 46228 Part 1 and ferrules with insulating collar according to DIN 46228 Part 4, 0.25 mm² ... 6.0 mm², lateral entry, trapezoidal crimp

Labeled terminal marker

Marker card - SK 3,5/2,8:FORTL.ZAHLEN - 0804073



Marker card, Card, white, labeled, Horizontal: consecutive numbers 1 - 10, 11 - 20, etc. up to 91 - 99, mounting type: adhesive, for terminal block width: 3.5 mm, lettering field size: 3.5 x 2.8 mm

Screwdriver tools

Printed-circuit board connector - FK-MCP 1,5/ 3-STF-3,5 - 1940101

Accessories

Screwdriver - SZS 0,4X2,5 VDE - 1205037



Screwdriver, slot-headed, VDE insulated, size: 0.4 x 2.5 x 80 mm, 2-component grip, with non-slip grip

Terminal marking

Marker card - SK U/2,8 WH:UNBEDRUCKT - 0803883



Marker card, Sheet, white, unlabeled, can be labeled with: CMS-P1-PLOTTER, PLOTMARK, Office printing systems, mounting type: adhesive, for terminal block width: 210 mm, lettering field size: 186 x 2.8 mm

Test plugs - MPS-MT 1-S - 1944372



Test plugs, consisting of \varnothing 1 mm test pin, 150 mm conductor length, and \varnothing 2 mm socket

Additional products

Printed-circuit board connector - MCV 1,5/ 3-GF-3,5 P20 THRR56 - 1780684



Header, nominal current: 8 A, rated voltage (III/2): 160 V, number of positions: 3, pitch: 3.5 mm, color: black, contact surface: Tin, mounting: THR soldering, User information and design recommendations for through hole reflow technology can be found under "Downloads"

Printed-circuit board connector - MC 1,5/ 3-GF-3,5 P26 THR - 1789180



Header, nominal current: 8 A, rated voltage (III/2): 160 V, number of positions: 3, pitch: 3.5 mm, color: black, contact surface: Tin, mounting: THR soldering

Printed-circuit board connector - FK-MCP 1,5/ 3-STF-3,5 - 1940101

Accessories

Printed-circuit board connector - MC 1,5/ 3-GF-3,5 P26 THRR56 - 1789193

Header, nominal current: 8 A, rated voltage (III/2): 160 V, number of positions: 3, pitch: 3.5 mm, color: black, contact surface: Tin, mounting: THR soldering



Printed-circuit board connector - MC 1,5/ 3-GF-3,5 P20 THRR56 - 1789410

Header, nominal current: 8 A, rated voltage (III/2): 160 V, number of positions: 3, pitch: 3.5 mm, color: black, contact surface: Tin, mounting: THR soldering



Printed-circuit board connector - MC 1,5/ 3-GF-3,5 P14 THR - 1789627

Header, nominal current: 8 A, rated voltage (III/2): 160 V, number of positions: 3, pitch: 3.5 mm, color: black, contact surface: Tin, mounting: THR soldering



Printed-circuit board connector - MC 1,5/ 3-GF-3,5 P14 THRR56 - 1789630

Header, nominal current: 8 A, rated voltage (III/2): 160 V, number of positions: 3, pitch: 3.5 mm, color: black, contact surface: Tin, mounting: THR soldering



Header - MCV 1,5/ 3-GF-3,5 - 1843237

Header, nominal current: 8 A, rated voltage (III/2): 160 V, number of positions: 3, pitch: 3.5 mm, color: green, contact surface: Tin, mounting: Wave soldering



Printed-circuit board connector - FK-MCP 1,5/ 3-STF-3,5 - 1940101

Accessories

Header - MC 1,5/ 3-GF-3,5 - 1843800

Header, nominal current: 8 A, rated voltage (III/2): 160 V, number of positions: 3, pitch: 3.5 mm, color: green, contact surface: Tin, mounting: Wave soldering



Header - EMC 1,5/ 3-GF-3,5 - 1897254

Header, nominal current: 8 A, rated voltage (III/2): 160 V, number of positions: 3, pitch: 3.5 mm, color: green, contact surface: Tin, mounting: Press-in technology



Header - EMCV 1,5/ 3-GF-3,5 - 1911172

Header, nominal current: 8 A, rated voltage (III/2): 160 V, number of positions: 3, pitch: 3.5 mm, color: green, contact surface: Tin, mounting: Press-in technology

