

Printed-circuit board connector - CCV 2,5/ 2-GF-5,08-LR P26THR - 1792737

Please be informed that the data shown in this PDF Document is generated from our Online Catalog. Please find the complete data in the user's documentation. Our General Terms of Use for Downloads are valid (<http://phoenixcontact.com/download>)

PCB headers, nominal current: 12 A, number of positions: 2, pitch: 5.08 mm, color: black, contact surface: Tin, mounting: THR soldering



The figure shows a 10-position version of the product

Your advantages

- ✓ Designed for integration into the SMT soldering process
- ✓ Vertical connection enables multi-row arrangement on the PCB
- ✓ Screwable flange for superior mechanical stability
- ✓ Automatic locking and intuitive release through Lock and Release operating lever in contrasting color
- ✓ Maximum flexibility when it comes to device design – one header for connectors with different connection technologies



Key Commercial Data

Packing unit	1 pc
Minimum order quantity	50 pc
GTIN	 4 046356 615747
GTIN	4046356615747
Weight per Piece (excluding packing)	2.400 g
Custom tariff number	85366930
Country of origin	Germany

Technical data

Dimensions

Length [!]	8.6 mm
------------	--------

Printed-circuit board connector - CCV 2,5/ 2-GF-5,08-LR P26THR - 1792737

Technical data

Dimensions

Width	20.32 mm
Pitch	5.08 mm
Dimension a	5.08 mm
Width [w]	20.32 mm
Height [h]	14.6 mm
Height	12 mm
Length of the solder pin	2.6 mm
Pin dimensions	1 x 1 mm
Length	8.6 mm

General

Range of articles	CCV 2,5/..-GF-LR
Insulating material group	IIIa
Rated surge voltage (III/3)	4 kV
Rated surge voltage (III/2)	4 kV
Rated surge voltage (II/2)	4 kV
Rated voltage (III/3)	250 V
Rated voltage (III/2)	320 V
Rated voltage (II/2)	400 V
Connection in acc. with standard	EN-VDE
Nominal current I _N	12 A
Insulating material	LCP
Flammability rating according to UL 94	V0
Color	black
Number of positions	2

Standards and Regulations

Connection in acc. with standard	EN-VDE
	CUL
Flammability rating according to UL 94	V0

Environmental Product Compliance

	Lead 7439-92-1
China RoHS	Environmentally Friendly Use Period = 50
	For details about hazardous substances go to tab "Downloads", Category "Manufacturer's declaration"

Drawings

Printed-circuit board connector - CCV 2,5/ 2-GF-5,08-LR P26THR - 1792737

Drilling diagram

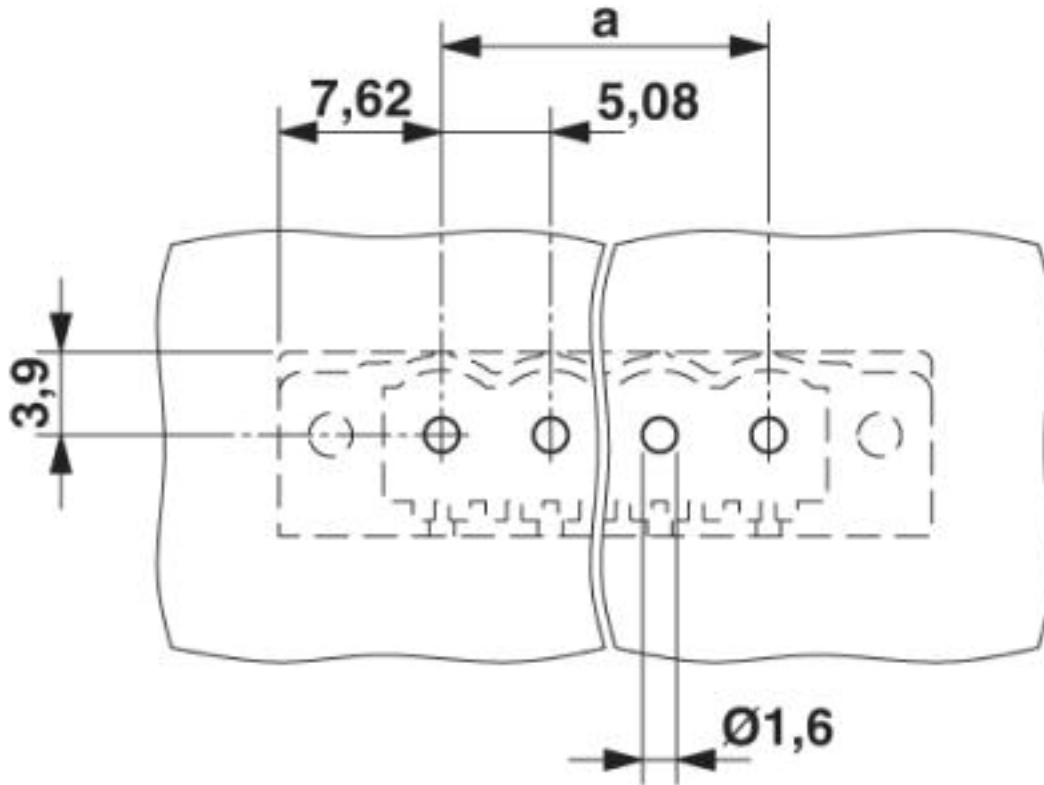

Printed-circuit board connector - CCV 2,5/ 2-GF-5,08-LR P26THR - 1792737

Diagram

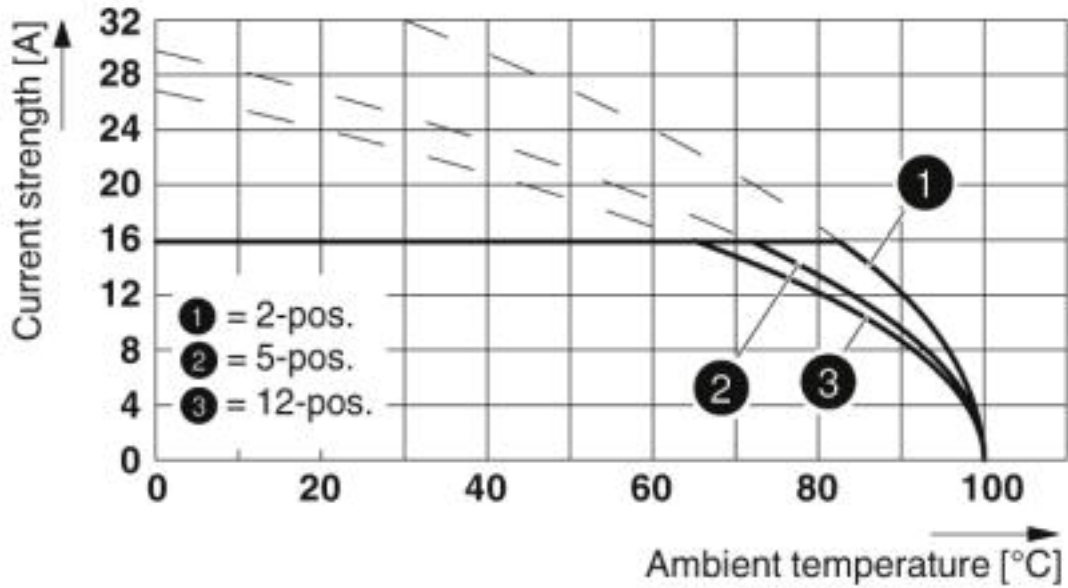

Derating curve for: MSTB 2,5 HC/...STF-5,08 with CCV 2,5/...GF-5,08 P26THR

Diagram

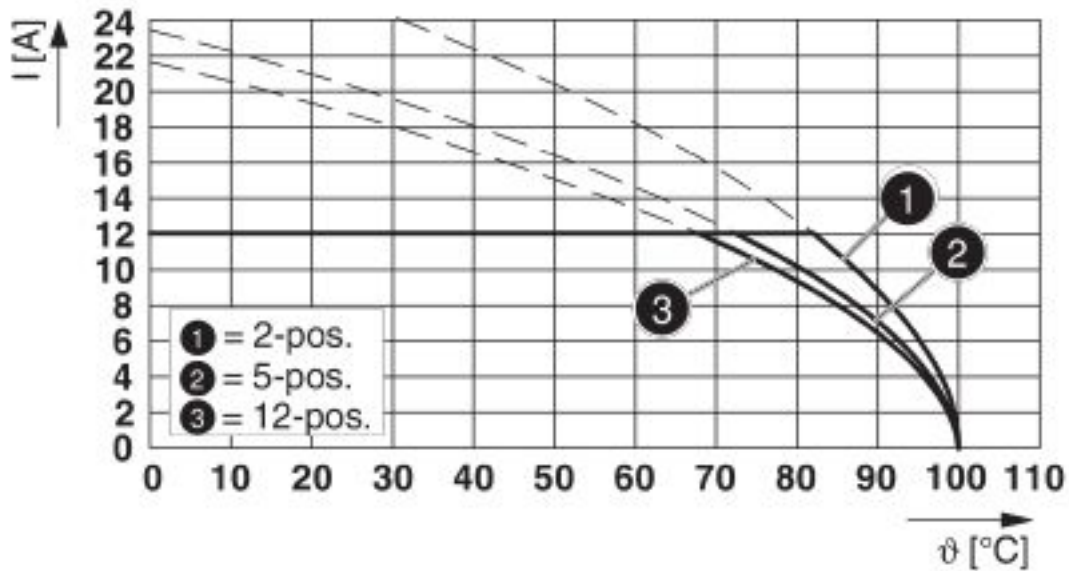

Type: MSTBT 2,5/...-STF-5,08 with CCV 2,5/...-GF-5,08 P...THR

Printed-circuit board connector - CCV 2,5/ 2-GF-5,08-LR P26THR - 1792737

Diagram

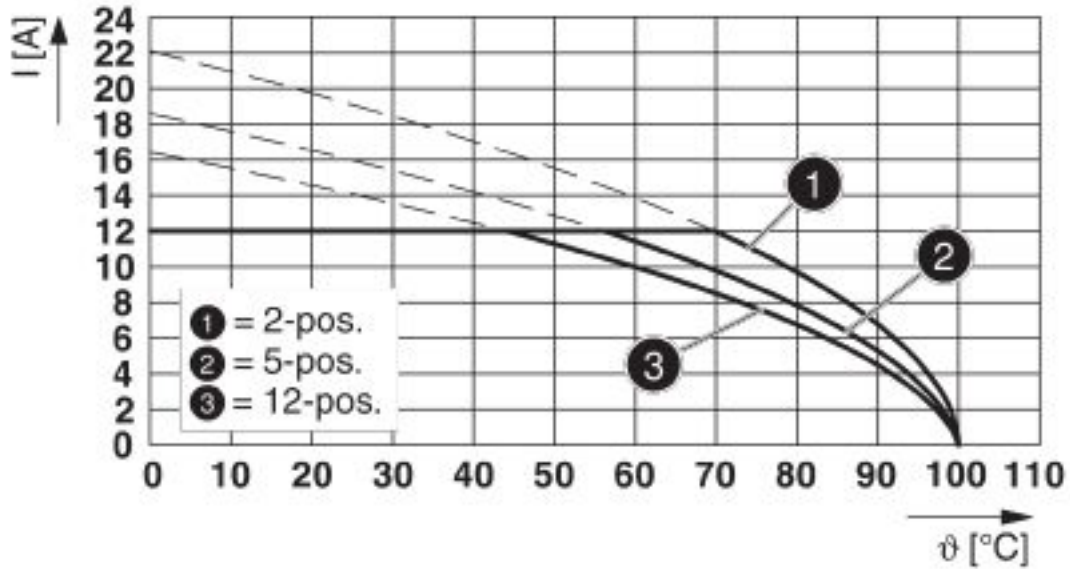

Type: MVSTB(R/W) 2,5/...-STF-5,08 with CCV 2,5/...-GF-5,08-LR P...THR

Diagram

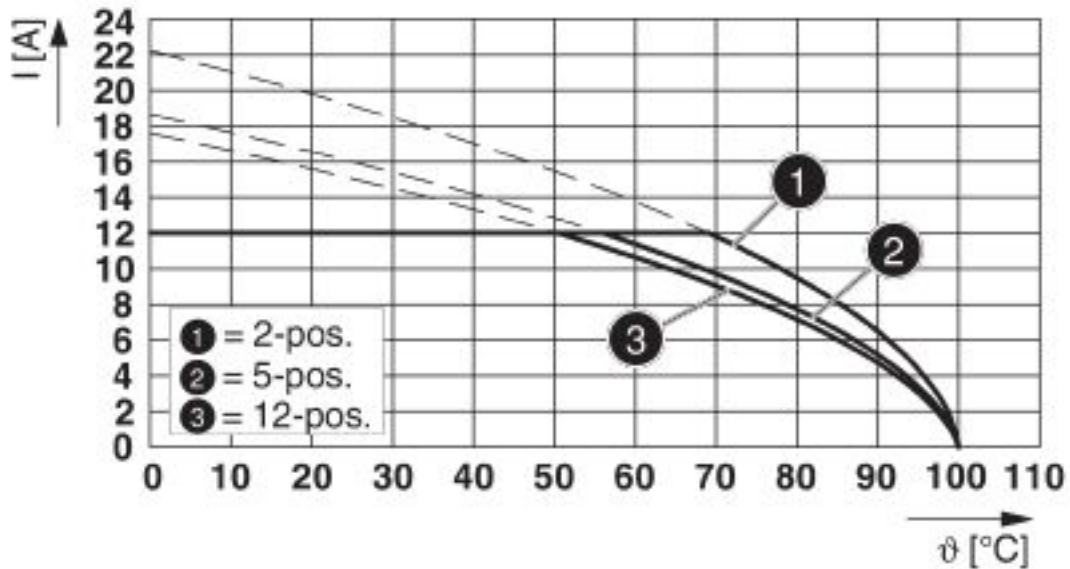

Type: SMSTB 2,5/...-STF-5,08 with CCV 2,5/...-GF-5,08-LR P...THR

Printed-circuit board connector - CCV 2,5/ 2-GF-5,08-LR P26THR - 1792737

Dimensional drawing

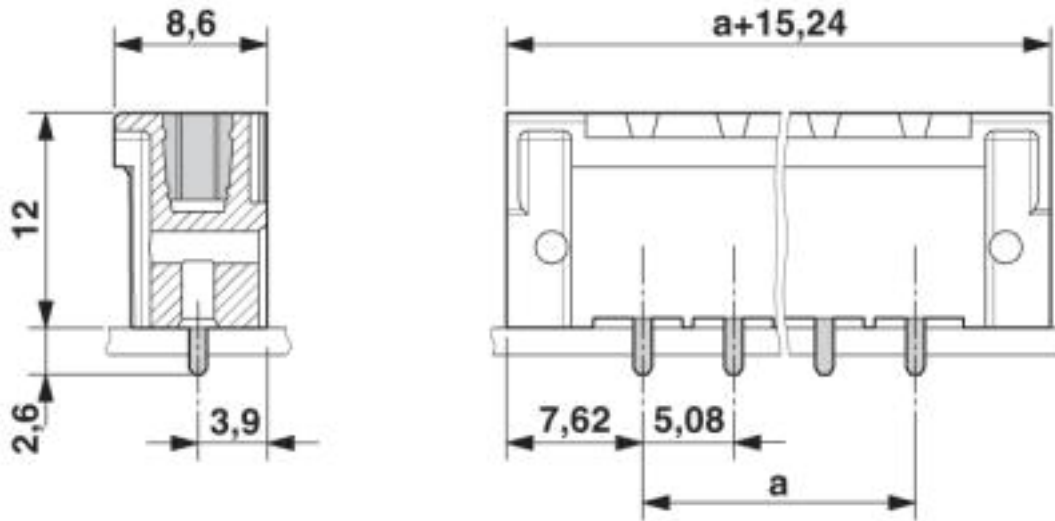

Schematic diagram

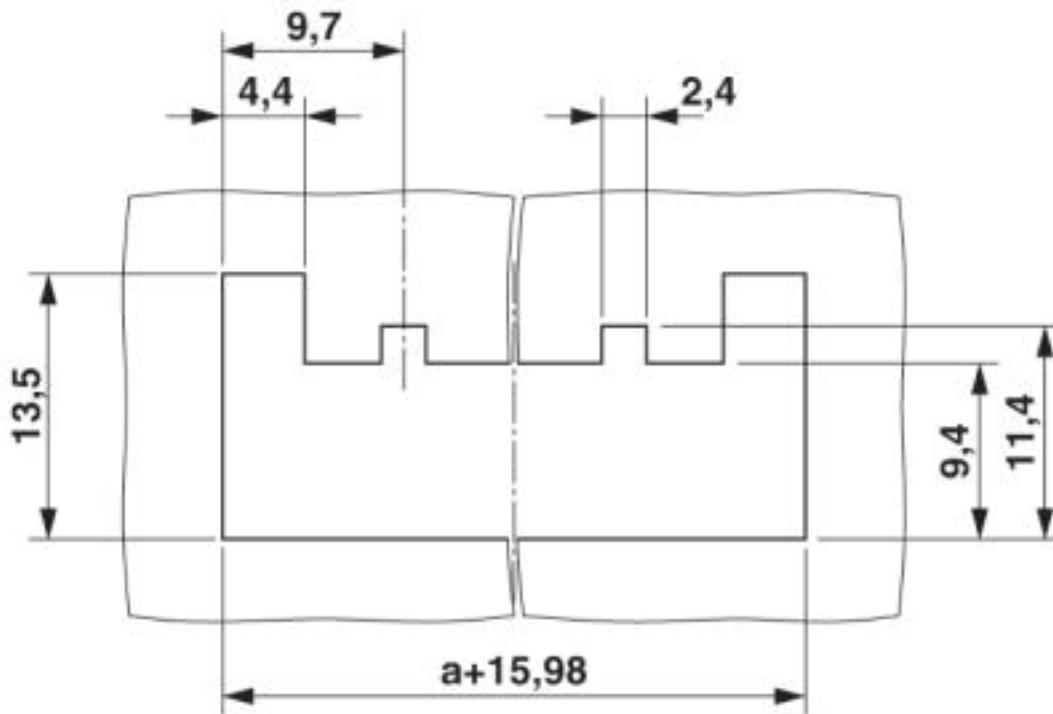

Panel cutout

Printed-circuit board connector - CCV 2,5/ 2-GF-5,08-LR P26THR - 1792737

Classifications

eCl@ss

eCl@ss 4.0	27260700
eCl@ss 4.1	27260700
eCl@ss 5.0	27260700
eCl@ss 5.1	27260700
eCl@ss 6.0	27260700
eCl@ss 7.0	27440402
eCl@ss 8.0	27440402
eCl@ss 9.0	27440402

ETIM

ETIM 4.0	EC002637
ETIM 5.0	EC002637
ETIM 6.0	EC002637
ETIM 7.0	EC002637

UNSPSC

UNSPSC 6.01	30211810
UNSPSC 7.0901	39121409
UNSPSC 11	39121409
UNSPSC 12.01	39121409
UNSPSC 13.2	39121409

Approvals

Approvals

Approvals

IECEE CB Scheme / VDE Gutachten mit Fertigungsüberwachung / EAC / cULus Recognized

Ex Approvals

Approval details

Printed-circuit board connector - CCV 2,5/ 2-GF-5,08-LR P26THR - 1792737

Approvals

IECEE CB Scheme		http://www.iecee.org/	DE1-58421-B1B2
Nominal voltage UN	400 V		
Nominal current IN	12 A		

VDE Gutachten mit Fertigungsüberwachung		http://www2.vde.com/de/Institut/Online-Service/VDE-gepruefteProdukte/Seiten/Online-Suche.aspx	40041286
Nominal voltage UN	400 V		
Nominal current IN	12 A		

EAC			B.01742
-----	---	--	---------

cULus Recognized		http://database.ul.com/cgi-bin/XYV/template/LISEXT/1FRAME/index.htm	E60425-19931011
	B	D	
Nominal voltage UN	300 V	300 V	
Nominal current IN	16 A	10 A	

Accessories

Accessories

Coding element

Coding section - CR-MSTB - 1734401

Coding section, inserted into the recess in the header or the inverted plug, red insulating material



Printed-circuit board connector - CCV 2,5/ 2-GF-5,08-LR P26THR - 1792737

Accessories

Coding section - CR-MSTB NAT HT - 1954362



HT coding section, prior to the reflow soldering process it is inserted into the recess on the header, made from high-temperature-resistant beige insulation material

Phoenix Contact 2019 © - all rights reserved
<http://www.phoenixcontact.com>