

MVSTBU 2,5/13-GB-5,08 - PCB header



1788648

<https://www.phoenixcontact.com/de/produkte/1788648>

Please be informed that the data shown in this PDF document is generated from our Online Catalog. Please find the complete data in the user documentation. Our General Terms of Use for Downloads are valid.



Direct plug-in block, nominal cross section: 2.5 mm², color: green, nominal current: 12 A, rated voltage (III/2): 320 V, contact surface: Tin, type of contact: Male connector, number of potentials: 13, number of rows: 1, number of positions: 13, number of connections: 13, product range: MVSTBU 2,5/...-GB, pitch: 5.08 mm, connection method: Screw connection with tension sleeve, screw head form: L Slotted, mounting: Direct mounting, conductor/PCB connection direction: 0 °, number of solder pins per potential: 1, plug-in system: COMBICON MSTB 2,5, locking: without, mounting: without, type of packaging: packed in cardboard

Your advantages

- Direct plug-in blocks with mounting flanges for screw connection on mounting plates or unit housing
- Can be combined with the MSTB 2,5 range
- Maximum flexibility when it comes to device design – one header for connectors with different connection technologies
- Well-known connection principle allows worldwide use
- Allows connection of two conductors

Commercial Data

Item number	1788648
Packing unit	50 pc
Minimum order quantity	50 pc
Sales Key	E1 - Leiterplattenanschl.
Product Key	AACMCA
Catalog Page	Page 357 (C-1-2013)
GTIN	4017918043704
Weight per Piece (including packing)	28,08 g
Weight per Piece (excluding packing)	27,263 g
Customs tariff number	85366990
Country of origin	DE

1788648

<https://www.phoenixcontact.com/de/produkte/1788648>

Technical Data

Product properties

Type	Direct mounting
Product line	COMBICON Connectors M
Product type	Direct plug-in block
Product family	MVSTBU 2,5/..-GB
Number of positions	13
Pitch	5.08 mm
Number of connections	13
Number of rows	1
Mounting flange	without
Number of potentials	13
Solder pins per potential	1

Electrical properties

Nominal current I_N	12 A
Nominal voltage U_N	320 V
Degree of pollution	3
Contact resistance	1.9 mΩ
Rated voltage (III/3)	320 V
Rated surge voltage (III/3)	4 kV
Rated voltage (III/2)	320 V
Rated surge voltage (III/2)	4 kV
	630 V
Rated surge voltage (II/2)	4 kV

Connection data

Connection technology

Type	Direct mounting
Connector system	COMBICON MSTB 2,5
Nominal cross section	2.5 mm ²
Type of contact	Male connector

Interlock

Locking type	without
Mounting flange	without

Conductor connection

Connection method	Screw connection with tension sleeve
Connection direction of the conductor to plug-in direction	0 °
Conductor cross section solid	0.2 mm ² ... 2.5 mm ²
Conductor cross section flexible	0.2 mm ² ... 2.5 mm ²
Conductor cross section AWG	24 ... 12

MVSTBU 2,5/13-GB-5,08 - PCB header



1788648

<https://www.phoenixcontact.com/de/produkte/1788648>

Conductor cross section flexible, with ferrule without plastic sleeve	0.25 mm ² ... 2.5 mm ²
Conductor cross section, flexible, with ferrule, with plastic sleeve	0.25 mm ² ... 2.5 mm ²
2 conductors with same cross section, solid	0.2 mm ² ... 1 mm ²
2 conductors with same cross section, flexible	0.2 mm ² ... 1.5 mm ²
2 conductors with same cross section, flexible, with ferrule without plastic sleeve	0.25 mm ² ... 1 mm ²
2 conductors with the same cross section, flexible, with TWIN ferrule with plastic sleeve	0.5 mm ² ... 1 mm ²
Cylindrical gauge a x b / diameter	2.8 mm x 2.0 mm / 2.4 mm
Stripping length	7 mm
Tightening torque	0.5 Nm ... 0.6 Nm

Mounting

Mounting type	Direct mounting
Drive form screw head	Slotted (L)
Drive form screw head	Slotted (L)

Material specifications

Material data - contact

Note	WEEE/RoHS-compliant, free of whiskers according to IEC 60068-2-82/JEDEC JESD 201
Contact material	Cu alloy
Surface characteristics	Tin-plated
Metal surface terminal point (top layer)	Tin (5 - 7 µm Sn)
Metal surface terminal point (middle layer)	Nickel (2 - 3 µm Ni)
Metal surface contact area (top layer)	Tin (5 - 7 µm Sn)
Metal surface contact area (middle layer)	Nickel (2 - 3 µm Ni)

Material data - housing

Color (Housing)	green (6021)
Insulating material	PA
Insulating material group	I
CTI according to IEC 60112	600
Flammability rating according to UL 94	V0
Glow wire flammability index GWFI according to EN 60695-2-12	850
Glow wire ignition temperature GWIT according to EN 60695-2-13	775
Temperature for the ball pressure test according to EN 60695-10-2	125 °C

Material data – actuating element

Color ()	()
-----------	-----

Notes

Notes on operation	In accordance with IEC 61984, COMBICON connectors have no switching power (COC). During designated use, they must not be
--------------------	--

MVSTBU 2,5/13-GB-5,08 - PCB header



1788648

<https://www.phoenixcontact.com/de/produkte/1788648>

plugged in or disconnected when carrying voltage or under load.

Dimensions

Pitch	5.08 mm
Width [w]	77.36 mm
Height [h]	17 mm
Length [l]	20.5 mm

Mechanical tests

Test for conductor damage and slackening

Specification	IEC 60999-1:1999-11
Result	Test passed

Pull-out test

Specification	IEC 60999-1:1999-11
Conductor cross section/conductor type/tractive force setpoint/actual value	0.2 mm ² / solid / > 10 N
	0.2 mm ² / flexible / > 10 N
	2.5 mm ² / solid / > 50 N
	2.5 mm ² / flexible / > 50 N

Insertion and withdrawal forces

Result	Test passed
No. of cycles	25
Insertion strength per pos. approx.	8 N
Withdraw strength per pos. approx.	6 N

Torque test

Specification	IEC 60999-1:1999-11
---------------	---------------------

Contact holder in insert

Specification	IEC 60512-15-1:2008-05
Contact holder in insert Requirements >20 N	Test passed

Resistance of inscriptions

Specification	IEC 60068-2-70:1995-12
Result	Test passed

Polarization and coding

Specification	IEC 60512-13-5:2006-02
Result	Test passed

Visual inspection

Specification	IEC 60512-1-1:2002-02
Result	Test passed

Dimension check

Specification	IEC 60512-1-2:2002-02
---------------	-----------------------

Result	Test passed
--------	-------------

Electrical tests

Thermal test | Test group C

Specification	IEC 60512-5-1:2002-02
Tested number of positions	20

Insulation resistance

Specification	IEC 60512-3-1:2002-02
Insulation resistance, neighboring positions	> 5 MΩ

Air clearances and creepage distances |

Specification	IEC 60664-1:2007-04
Insulating material group	I
Comparative tracking index (IEC 60112)	CTI 600
Rated insulation voltage (III/3)	320 V
Rated surge voltage (III/3)	4 kV
minimum clearance value - non-homogenous field (III/3)	3 mm
minimum creepage distance (III/3)	4 mm
Rated insulation voltage (III/2)	320 V
Rated surge voltage (III/2)	4 kV
minimum clearance value - non-homogenous field (III/2)	3 mm
minimum creepage distance (III/2)	3 mm
Rated insulation voltage (II/2)	630 V
Rated surge voltage (II/2)	4 kV
minimum clearance value - non-homogenous field (II/2)	3 mm
minimum creepage distance (II/2)	3.2 mm

Environmental and real-life conditions

Vibration test

Specification	IEC 60068-2-6:2007-12
Frequency	10 - 150 - 10 Hz
Sweep speed	1 octave/min
Amplitude	0.35 mm (10 Hz ... 60.1 Hz)
Sweep speed	5g (60.1 Hz ... 150 Hz)
Test duration per axis	2.5 h

Durability test

Specification	IEC 60512-9-1:2010-03
Impulse withstand voltage at sea level	4.8 kV
Contact resistance R ₁	1.9 mΩ
Contact resistance R ₂	2.2 mΩ
Insertion/withdrawal cycles	25
Insulation resistance, neighboring positions	> 5 MΩ

MVSTBU 2,5/13-GB-5,08 - PCB header



1788648

<https://www.phoenixcontact.com/de/produkte/1788648>

Climatic test

Specification	ISO 6988:1985-02
Corrosive stress	0.2 dm ³ SO ₂ on 300 dm ³ /40 °C/1 cycle
Thermal stress	100 °C/168 h
Power-frequency withstand voltage	2.21 kV

Ambient conditions

Ambient temperature (operation)	-40 °C ... 100 °C (dependent on the derating curve)
Ambient temperature (storage/transport)	-40 °C ... 70 °C
Relative humidity (storage/transport)	30 % ... 70 %
Ambient temperature (assembly)	-5 °C ... 100 °C

Packaging specifications

Type of packaging	packed in cardboard
-------------------	---------------------

Drawings

Drilling plan/solder pad geometry

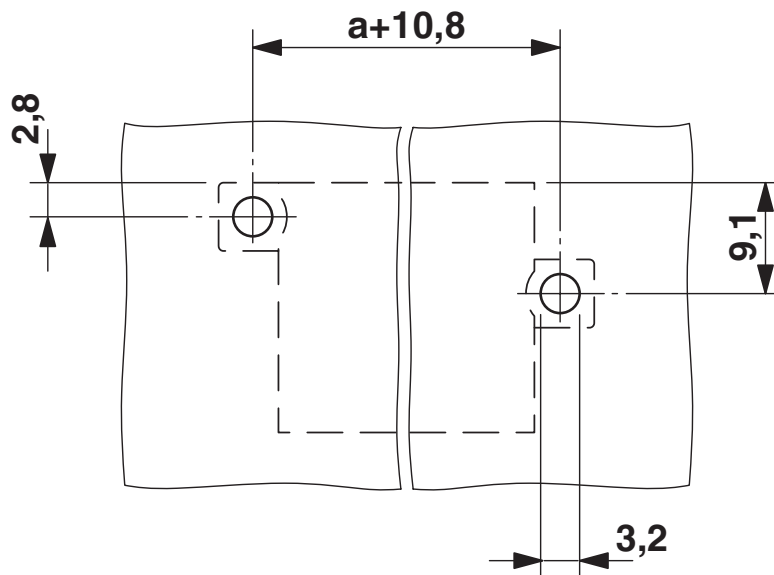

Diagram

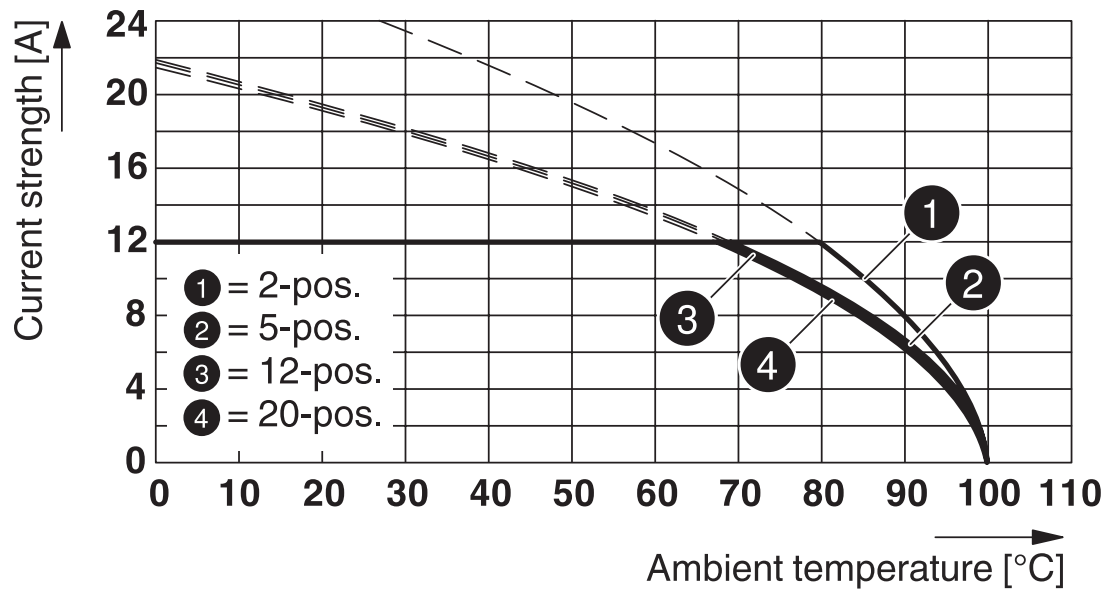

Type: MSTB 2,5/...-ST-5,08 with MVSTBU 2,5/...-GB-5,08

MVSTBU 2,5/13-GB-5,08 - PCB header

1788648

<https://www.phoenixcontact.com/de/produkte/1788648>

Dimensional drawing

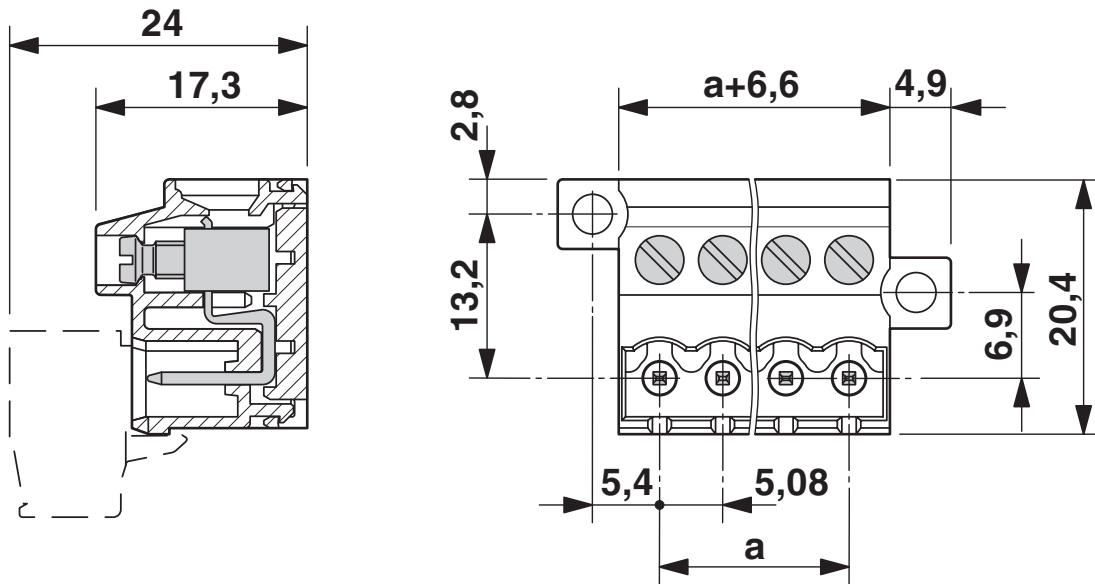

MVSTBU 2,5/13-GB-5,08 - PCB header



1788648

<https://www.phoenixcontact.com/de/produkte/1788648>

Approvals

 CSA Approval ID: 13631				
	Nominal Voltage U_N	Nominal Current I_N	Cross Section AWG	Cross Section mm^2
Use group B	300 V	10 A	28 - 12	-
Use group D	300 V	10 A	28 - 12	-

 IECEE CB Scheme Approval ID: DE1-60988-B1B2				
	Nominal Voltage U_N	Nominal Current I_N	Cross Section AWG	Cross Section mm^2
	250 V	12 A	-	0.2 - 2.5

 EAC Approval ID: B.01687				
--	--	--	--	--

 cULus Recognized Approval ID: E60425-19931014				
	Nominal Voltage U_N	Nominal Current I_N	Cross Section AWG	Cross Section mm^2
Use group B				
Multi-conductor connection	250 V	12 A	2x - 16	-
Screw connection		12 A	30 - 12	-
Use group D				
Multi-conductor connection	300 V	10 A	2x - 16	-
Screw connection		10 A	30 - 12	-

 VDE Zeichengenehmigung Approval ID: 40050694				
	Nominal Voltage U_N	Nominal Current I_N	Cross Section AWG	Cross Section mm^2
	250 V	12 A	-	0.2 - 2.5

1788648

<https://www.phoenixcontact.com/de/produkte/1788648>

Classifications

ECLASS

ECLASS-9.0	27440309
ECLASS-10.0.1	27440309
ECLASS-11.0	27460202

ETIM

ETIM 8.0	EC002638
----------	----------

UNSPSC

UNSPSC 21.0	39121400
-------------	----------

MVSTBU 2,5/13-GB-5,08 - PCB header



1788648

<https://www.phoenixcontact.com/de/produkte/1788648>

Environmental Product Compliance

China RoHS	Environmentally friendly use period: unlimited = EFUP-e
	No hazardous substances above threshold values

MVSTBU 2,5/13-GB-5,08 - PCB header

1788648

<https://www.phoenixcontact.com/de/produkte/1788648>

Accessories

SK 5,08/3,8:FORTL.ZAHLEN - Marker card

0804293

<https://www.phoenixcontact.com/de/produkte/0804293>



Marker card, white, labeled, horizontal: consecutive numbers 1 ... 10, 11 ... 20, etc. up to 91 ... (99)100, mounting type: adhesive, for terminal block width: 5.08 mm, lettering field size: 5.08 x 3.8 mm

EBP 2- 5 - Insertion bridge

1733169

<https://www.phoenixcontact.com/de/produkte/1733169>

Insertion bridge for connectors with 5.0 mm or 5.08 mm pitch



MVSTBU 2,5/13-GB-5,08 - PCB header

1788648

<https://www.phoenixcontact.com/de/produkte/1788648>

CR-MSTB - Coding section

1734401

<https://www.phoenixcontact.com/de/produkte/1734401>

Coding section, inserted into the recess in the header or the inverted plug, red insulating material



SZS 0,6X3,5 - Screwdriver

1205053

<https://www.phoenixcontact.com/de/produkte/1205053>

Actuation tool, for ST terminal blocks, insulated, also suitable for use as a bladed screwdriver, size: 0.6 x 3.5 x 100 mm, 2-component grip, with non-slip grip



MVSTBU 2,5/13-GB-5,08 - PCB header

1788648

<https://www.phoenixcontact.com/de/produkte/1788648>

MSTB-BL - Accessories

1755477

<https://www.phoenixcontact.com/de/produkte/1755477>



Keying cap, for forming sections, plugs onto header pin, green insulating material

MSTB 2,5/13-ST-5,08 - PCB connector

1757129

<https://www.phoenixcontact.com/de/produkte/1757129>



PCB connector, nominal cross section: 2.5 mm², color: green, nominal current: 12 A, rated voltage (III/2): 320 V, contact surface: Tin, type of contact: Female connector, number of potentials: 13, number of rows: 1, number of positions: 13, number of connections: 13, product range: MSTB 2,5/..-ST, pitch: 5.08 mm, connection method: Screw connection with tension sleeve, screw head form: L Slotted, conductor/PCB connection direction: 0 °, locking clip: - Locking clip, plug-in system: COMBICON MSTB 2,5, locking: without, mounting: without, type of packaging: packed in cardboard

MVSTBU 2,5/13-GB-5,08 - PCB header

1788648

<https://www.phoenixcontact.com/de/produkte/1788648>

MSTB 2,5/13-STZ-5,08 - PCB connector

1764277

<https://www.phoenixcontact.com/de/produkte/1764277>



PCB connector, nominal cross section: 2.5 mm², color: green, nominal current: 12 A, rated voltage (III/2): 320 V, contact surface: Tin, type of contact: Female connector, number of potentials: 13, number of rows: 1, number of positions: 13, number of connections: 13, product range: MSTB 2,5/...-STZ, pitch: 5.08 mm, connection method: Screw connection with tension sleeve, screw head form: L Slotted, conductor/PCB connection direction: 0 °, locking clip: - Locking clip, plug-in system: COMBICON MSTB 2,5, locking: without, mounting: without, type of packaging: packed in cardboard

MSTBP 2,5/13-ST-5,08 - PCB connector

1769120

<https://www.phoenixcontact.com/de/produkte/1769120>



PCB connector, nominal cross section: 2.5 mm², color: green, nominal current: 12 A, rated voltage (III/2): 320 V, contact surface: Tin, type of contact: Female connector, number of potentials: 13, number of rows: 1, number of positions: 13, number of connections: 13, product range: MSTBP 2,5/...-ST, pitch: 5.08 mm, connection method: Screw connection with tension sleeve, screw head form: L Slotted, conductor/PCB connection direction: 0 °, locking clip: - Locking clip, plug-in system: COMBICON MSTB 2,5, locking: without, mounting: without, type of packaging: packed in cardboard

MVSTBU 2,5/13-GB-5,08 - PCB header

1788648

<https://www.phoenixcontact.com/de/produkte/1788648>

SMSTB 2,5/13-ST-5,08 - PCB connector

1826393

<https://www.phoenixcontact.com/de/produkte/1826393>



PCB connector, nominal cross section: 2.5 mm², color: green, nominal current: 12 A, rated voltage (III/2): 320 V, contact surface: Tin, type of contact: Female connector, number of potentials: 13, number of rows: 1, number of positions: 13, number of connections: 13, product range: SMSTB 2,5/..-ST, pitch: 5.08 mm, connection method: Screw connection with tension sleeve, screw head form: L Slotted, conductor/PCB connection direction: -45 °, locking clip: - Locking clip, plug-in system: COMBICON MSTB 2,5, locking: without, mounting: without, type of packaging: packed in cardboard

MVSTBR 2,5/13-ST-5,08 - PCB connector

1792359

<https://www.phoenixcontact.com/de/produkte/1792359>



PCB connector, nominal cross section: 2.5 mm², color: green, nominal current: 12 A, rated voltage (III/2): 320 V, contact surface: Tin, type of contact: Female connector, number of potentials: 13, number of rows: 1, number of positions: 13, number of connections: 13, product range: MVSTBR 2,5/..-ST, pitch: 5.08 mm, connection method: Screw connection with tension sleeve, screw head form: L Slotted, conductor/PCB connection direction: 90 °, locking clip: - Locking clip, plug-in system: COMBICON MSTB 2,5, locking: without, mounting: without, type of packaging: packed in cardboard

MVSTBU 2,5/13-GB-5,08 - PCB header

1788648

<https://www.phoenixcontact.com/de/produkte/1788648>



MVSTBW 2,5/13-ST-5,08 - PCB connector

1792867

<https://www.phoenixcontact.com/de/produkte/1792867>



PCB connector, nominal cross section: 2.5 mm², color: green, nominal current: 12 A, rated voltage (III/2): 320 V, contact surface: Tin, type of contact: Female connector, number of potentials: 13, number of rows: 1, number of positions: 13, number of connections: 13, product range: MVSTBW 2,5/..-ST, pitch: 5.08 mm, connection method: Screw connection with tension sleeve, screw head form: L Slotted, conductor/PCB connection direction: -90 °, locking clip: - Locking clip, plug-in system: COMBICON MSTB 2,5, locking: without, mounting: without, type of packaging: packed in cardboard

FRONT-MSTB 2,5/13-ST-5,08 - PCB connector

1777390

<https://www.phoenixcontact.com/de/produkte/1777390>



PCB connector, nominal cross section: 2.5 mm², color: green, nominal current: 12 A, rated voltage (III/2): 320 V, contact surface: Tin, type of contact: Female connector, number of potentials: 13, number of rows: 1, number of positions: 13, number of connections: 13, product range: FRONT-MSTB 2,5/..-ST, pitch: 5.08 mm, connection method: Front screw connection, screw head form: L Slotted, conductor/PCB connection direction: 0 °, locking clip: - Locking clip, plug-in system: COMBICON MSTB 2,5, locking: without, mounting: without, type of packaging: packed in cardboard

MVSTBU 2,5/13-GB-5,08 - PCB header

1788648

<https://www.phoenixcontact.com/de/produkte/1788648>



FKC 2,5/13-ST-5,08 - PCB connector

1873168

<https://www.phoenixcontact.com/de/produkte/1873168>

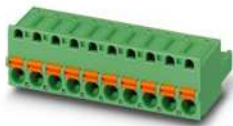

PCB connector, nominal cross section: 2.5 mm², color: green, nominal current: 12 A, rated voltage (III/2): 320 V, contact surface: Tin, type of contact: Female connector, number of potentials: 13, number of rows: 1, number of positions: 13, number of connections: 13, product range: FKC 2,5/...-ST, pitch: 5.08 mm, connection method: Push-in spring connection, conductor/PCB connection direction: 0 °, locking clip: - Locking clip, plug-in system: COMBICON MSTB 2,5, locking: without, mounting: without, type of packaging: packed in cardboard

FKCVR 2,5/13-ST-5,08 - PCB connector

1874060

<https://www.phoenixcontact.com/de/produkte/1874060>

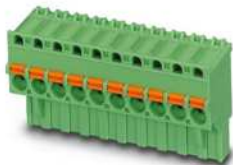

PCB connector, nominal cross section: 2.5 mm², color: green, nominal current: 12 A, rated voltage (III/2): 320 V, contact surface: Tin, type of contact: Female connector, number of potentials: 13, number of rows: 1, number of positions: 13, number of connections: 13, product range: FKCVR 2,5/...-ST, pitch: 5.08 mm, connection method: Push-in spring connection, conductor/PCB connection direction: 90 °, locking clip: - Locking clip, plug-in system: COMBICON MSTB 2,5, locking: without, mounting: without, type of packaging: packed in cardboard

MVSTBU 2,5/13-GB-5,08 - PCB header

1788648

<https://www.phoenixcontact.com/de/produkte/1788648>

QC 1/13-ST-5,08 - PCB connector

1883815

<https://www.phoenixcontact.com/de/produkte/1883815>

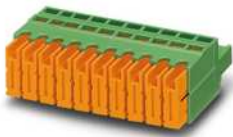

PCB connector, nominal cross section: 1 mm², color: green, nominal current: 10 A, rated voltage (III/2): 630 V, contact surface: Tin, type of contact: Female connector, number of potentials: 13, number of rows: 1, number of positions: 13, number of connections: 13, product range: QC 1/..-ST, pitch: 5.08 mm, connection method: Displacement connection, conductor/PCB connection direction: 0 °, locking clip: - Locking clip, plug-in system: COMBICON MSTB 2,5, locking: without, mounting: without, type of packaging: packed in cardboard

MSTBC 2,5/13-ST-5,08 - PCB connector

1808926

<https://www.phoenixcontact.com/de/produkte/1808926>



PCB connector, nominal cross section: 2.5 mm², color: green, nominal current: 12 A, rated voltage (III/2): 320 V, type of contact: Female connector, number of potentials: 13, number of rows: 1, number of positions: 13, number of connections: 13, product range: MSTBC 2,5/..-ST, pitch: 5.08 mm, connection method: Crimp connection, conductor/PCB connection direction: 0 °, locking clip: - Locking clip, plug-in system: COMBICON MSTB 2,5, locking: without, mounting: without, type of packaging: packed in cardboard, Corresponding female crimp contacts with current [A] and conductor cross section range [mm²] data: 10A/MSTBC-MT 0,5-1,0 (3190564); 10A/MSTBC-MT 0,5-1,0 BA (3190645); 12A/MSTBC-MT 1,5-2,5 (3190551); 12A/MSTBC-MT 1,5-2,5 BA (3190658). BA = Bandkontakte

MVSTBU 2,5/13-GB-5,08 - PCB header



1788648

<https://www.phoenixcontact.com/de/produkte/1788648>

MSTBC 2,5/13-STZ-5,08 - PCB connector

1809611

<https://www.phoenixcontact.com/de/produkte/1809611>



PCB connector, nominal cross section: 2.5 mm², color: green, nominal current: 12 A, rated voltage (III/2): 320 V, type of contact: Female connector, number of potentials: 13, number of rows: 1, number of positions: 13, number of connections: 13, product range: MSTBC 2,5/...-STZ, pitch: 5.08 mm, connection method: Crimp connection, conductor/PCB connection direction: 0 °, locking clip: - Locking clip, plug-in system: COMBICON MSTB 2,5, locking: without, mounting: without, type of packaging: packed in cardboard, Corresponding female crimp contacts with current [A] and conductor cross section range [mm²] data: 10A/MSTBC-MT 0,5-1,0 (3190564); 10A/MSTBC-MT 0,5-1,0 BA (3190645); 12A/MSTBC-MT 1,5-2,5 (3190551); 12A/MSTBC-MT 1,5-2,5 BA (3190658). BA = Bandkontakte

Phoenix Contact 2023 © - all rights reserved
<https://www.phoenixcontact.com>

PHOENIX CONTACT Deutschland GmbH
Flachmarktstraße 8
D-32825 Blomberg
+49 52 35/3-1 20 00
info@phoenixcontact.de