

Printed-circuit board connector - MVSTBU 2,5/ 6-GFB-5,08 - 1788389

Please be informed that the data shown in this PDF Document is generated from our Online Catalog. Please find the complete data in the user's documentation. Our General Terms of Use for Downloads are valid (<http://phoenixcontact.com/download>)

Direct plug-in block, nominal current: 12 A, rated voltage (III/2): 320 V, Nominal cross section: 2.5 mm², number of positions: 6, pitch: 5.08 mm, connection method: Screw connection with tension sleeve, color: green, contact surface: Tin, mounting: Direct mounting



The figure shows a 10-position version of the product

Your advantages

- ✓ Direct plug-in blocks with mounting flanges for screw connection on mounting plates or unit housing
- ✓ Can be combined with the MSTB 2,5 range
- ✓ Maximum flexibility when it comes to device design – one header for connectors with different connection technologies
- ✓ Well-known connection principle allows worldwide use
- ✓ Allows connection of two conductors



Key Commercial Data

Packing unit	1 pc
Minimum order quantity	50 pc
GTIN	 4 017918 043445
GTIN	4017918043445
Weight per Piece (excluding packing)	14.630 g
Custom tariff number	85366990
Country of origin	Germany

Technical data

Dimensions

Length [l]	20.5 mm
Width [w]	41.8 mm
Height [h]	17.3 mm

Printed-circuit board connector - MVSTBU 2,5/ 6-GFB-5,08 - 1788389

Technical data

Dimensions

Pitch	5.08 mm
Dimension a	25.4 mm

General

Range of articles	MVSTBU 2,5/..-GFB
Number of positions	6
Connection method	Screw connection with tension sleeve
Insulating material group	I
Rated surge voltage (III/3)	4 kV
Rated surge voltage (III/2)	4 kV
Rated surge voltage (II/2)	4 kV
Rated voltage (III/3)	320 V
Rated voltage (III/2)	320 V
Rated voltage (II/2)	630 V
Connection in acc. with standard	EN-VDE
Nominal current I_N	12 A
Nominal cross section	2.5 mm ²
Maximum load current	12 A
Insulating material	PA
Flammability rating according to UL 94	V0
Internal cylindrical gage	A3
Stripping length	7 mm
Screw thread	M3
Tightening torque, min	0.5 Nm
Tightening torque max	0.6 Nm

Connection data

Conductor cross section solid min.	0.2 mm ²
Conductor cross section solid max.	2.5 mm ²
Conductor cross section flexible min.	0.2 mm ²
Conductor cross section flexible max.	2.5 mm ²
Conductor cross section flexible, with ferrule without plastic sleeve min.	0.25 mm ²
Conductor cross section flexible, with ferrule without plastic sleeve max.	2.5 mm ²
Conductor cross section flexible, with ferrule with plastic sleeve min.	0.25 mm ²
Conductor cross section flexible, with ferrule with plastic sleeve max.	2.5 mm ²
Conductor cross section AWG min.	24
Conductor cross section AWG max.	12
2 conductors with same cross section, solid min.	0.2 mm ²

Printed-circuit board connector - MVSTBU 2,5/ 6-GFB-5,08 - 1788389

Technical data

Connection data

2 conductors with same cross section, solid max.	1 mm ²
2 conductors with same cross section, stranded min.	0.2 mm ²
2 conductors with same cross section, stranded max.	1.5 mm ²
2 conductors with same cross section, stranded, ferrules without plastic sleeve, min.	0.25 mm ²
2 conductors with same cross section, stranded, ferrules without plastic sleeve, max.	1 mm ²
2 conductors with same cross section, stranded, TWIN ferrules with plastic sleeve, min.	0.5 mm ²
2 conductors with same cross section, stranded, TWIN ferrules with plastic sleeve, max.	1 mm ²
Minimum AWG according to UL/CUL	30
Maximum AWG according to UL/CUL	12

Standards and Regulations

Connection in acc. with standard	EN-VDE
	CSA
Flammability rating according to UL 94	V0

Environmental Product Compliance

	Lead 7439-92-1
China RoHS	Environmentally Friendly Use Period = 50
	For details about hazardous substances go to tab "Downloads", Category "Manufacturer's declaration"

Drawings

Printed-circuit board connector - MVSTBU 2,5/ 6-GFB-5,08 - 1788389

Drilling diagram

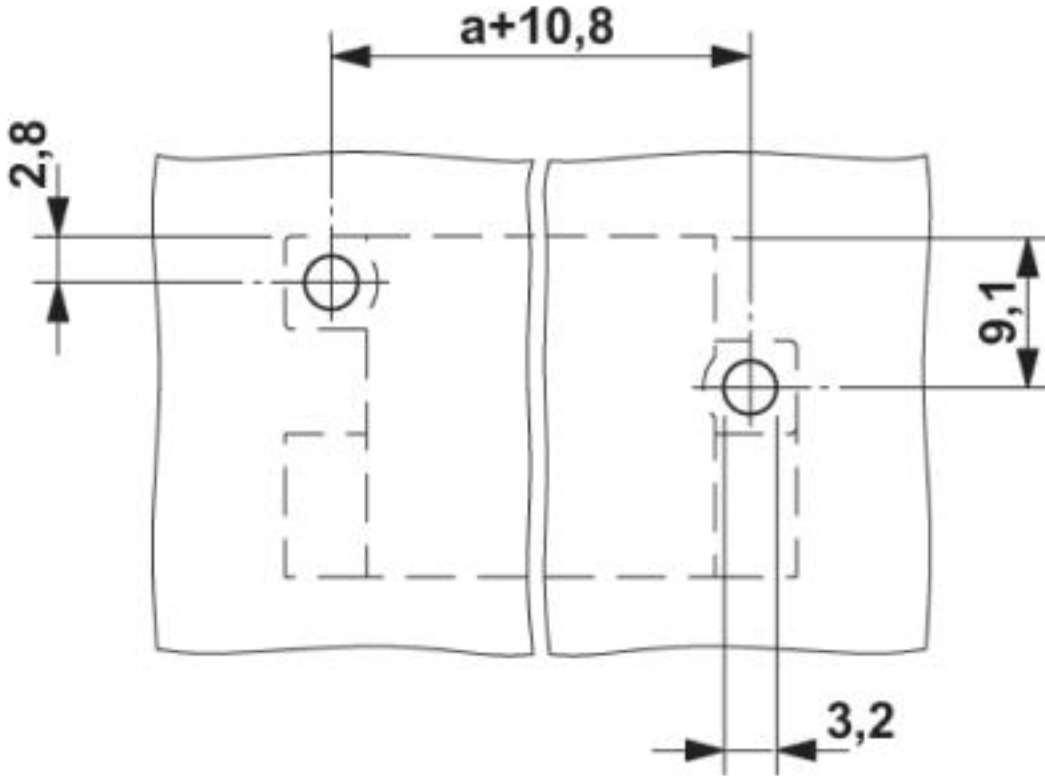

Dimensional drawing

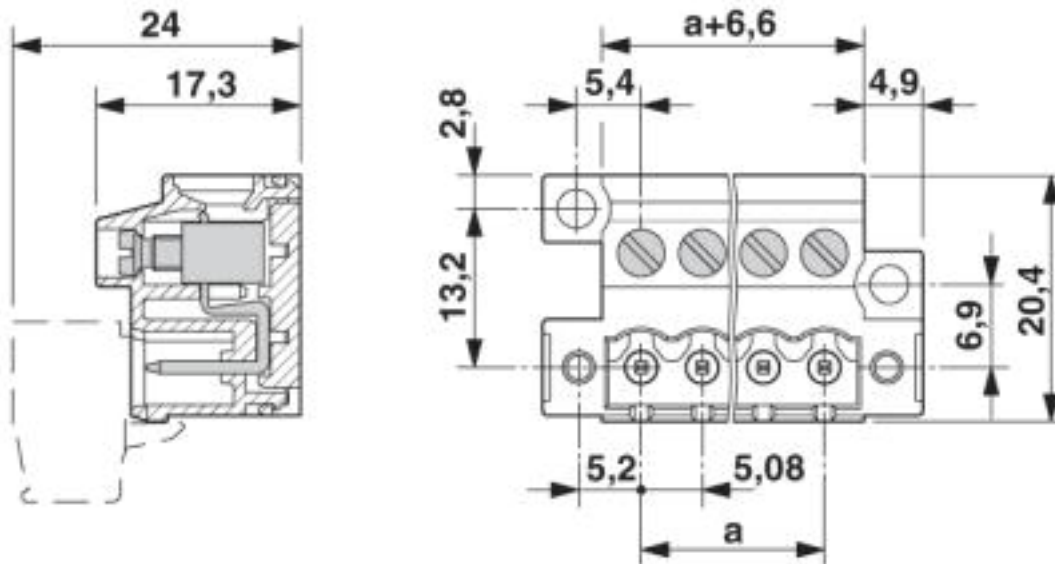

Printed-circuit board connector - MVSTBU 2,5/ 6-GFB-5,08 - 1788389

Classifications

eCl@ss

eCl@ss 4.0	27260700
eCl@ss 4.1	27260700
eCl@ss 5.0	27141100
eCl@ss 5.1	27141100
eCl@ss 6.0	27141100
eCl@ss 7.0	27141106
eCl@ss 8.0	27141106
eCl@ss 9.0	27141106

ETIM

ETIM 3.0	EC001121
ETIM 4.0	EC002637
ETIM 5.0	EC001284
ETIM 6.0	EC001284
ETIM 7.0	EC001284

UNSPSC

UNSPSC 6.01	30211810
UNSPSC 7.0901	39121409
UNSPSC 11	39121409
UNSPSC 12.01	39121409
UNSPSC 13.2	39121409
UNSPSC 18.0	39121409
UNSPSC 19.0	39121409
UNSPSC 20.0	39121409
UNSPSC 21.0	39121409

Approvals

Approvals

Approvals

CSA / IECCEB CB Scheme / VDE Gutachten mit Fertigungsüberwachung / EAC / cULus Recognized

Ex Approvals

Printed-circuit board connector - MVSTBU 2,5/ 6-GFB-5,08 - 1788389

Approvals

Approval details

CSA		http://www.csagroup.org/services-industries/product-listing/	13631
Nominal voltage UN		300 V	
Nominal current IN		10 A	
mm ² /AWG/kcmil		28-12	

IECEE CB Scheme		http://www.iecee.org/	DE1-60988-B1B2
Nominal voltage UN		250 V	
Nominal current IN		12 A	
mm ² /AWG/kcmil		0.2-2.5	

VDE Gutachten mit Fertigungsüberwachung		http://www2.vde.com/de/Institut/Online-Service/ VDE-gepruefteProdukte/Seiten/Online-Suche.aspx	40004701
Nominal voltage UN		250 V	
Nominal current IN		12 A	
mm ² /AWG/kcmil		0.2-2.5	

EAC			B.01742
-----	---	--	---------

cULus Recognized		http://database.ul.com/cgi-bin/XYV/template/LISEXT/1FRAME/index.htm	E60425-19931014
	B	D	
Nominal voltage UN	250 V	300 V	
Nominal current IN	12 A	10 A	
mm ² /AWG/kcmil	30-12	30-12	

Printed-circuit board connector - MVSTBU 2,5/ 6-GFB-5,08 - 1788389

Accessories

Accessories

Bridge

Insertion bridge - EBP 2- 5 - 1733169



Coding element

Coding section - CR-MSTB - 1734401



Coding section, inserted into the recess in the header or the inverted plug, red insulating material

Labeled terminal marker

Marker card - SK 5,08/3,8:FORTL.ZAHLEN - 0804293



Marker card, Card, white, labeled, Horizontal: consecutive numbers 1 ... 10, 11 ... 20, etc. up to 91 ... (99)100, mounting type: adhesive, for terminal block width: 5.08 mm, lettering field size: 5.08 x 3.8 mm

Screwdriver tools

Screwdriver - SZS 0,6X3,5 - 1205053



Actuation tool, for ST terminal blocks, insulated, also suitable for use as a bladed screwdriver, size: 0.6 x 3.5 x 100 mm, 2-component grip, with non-slip grip

Additional products

Printed-circuit board connector - MVSTBU 2,5/ 6-GFB-5,08 - 1788389

Accessories

Printed-circuit board connector - MSTB 2,5/ 6-STF-5,08 - 1778027

PCB connector, nominal current: 12 A, rated voltage (III/2): 320 V, Nominal cross section: 2.5 mm², number of positions: 6, pitch: 5.08 mm, connection method: Screw connection with tension sleeve, color: green, contact surface: Tin



Printed-circuit board connector - MVSTBR 2,5/ 6-STF-5,08 - 1835135

PCB connector, nominal current: 12 A, rated voltage (III/2): 320 V, Nominal cross section: 2.5 mm², number of positions: 6, pitch: 5.08 mm, connection method: Screw connection with tension sleeve, color: green, contact surface: Tin



Printed-circuit board connector - MVSTBW 2,5/ 6-STF-5,08 - 1834945

PCB connector, nominal current: 12 A, rated voltage (III/2): 320 V, Nominal cross section: 2.5 mm², number of positions: 6, pitch: 5.08 mm, connection method: Screw connection with tension sleeve, color: green, contact surface: Tin



Printed-circuit board connector - FKCV 2,5/ 6-STF-5,08 - 1873249

PCB connector, nominal current: 12 A, rated voltage (III/2): 320 V, Nominal cross section: 2.5 mm², number of positions: 6, pitch: 5.08 mm, connection method: Push-in spring connection, color: green, contact surface: Tin



Printed-circuit board connector - FKCVR 2,5/ 6-STF-5,08 - 1874141

PCB connector, nominal current: 12 A, rated voltage (III/2): 320 V, Nominal cross section: 2.5 mm², number of positions: 6, pitch: 5.08 mm, connection method: Push-in spring connection, color: green, contact surface: Tin



Printed-circuit board connector - MVSTBU 2,5/ 6-GFB-5,08 - 1788389

Accessories

Printed-circuit board connector - QC 1/ 6-STF-5,08 - 1883394

PCB connector, nominal current: 10 A, rated voltage (III/2): 630 V, Nominal cross section: 1 mm², number of positions: 6, pitch: 5.08 mm, connection method: Displacement connection, color: green, contact surface: Tin



Printed-circuit board connector - MSTBC 2,5/ 6-STZF-5,08 - 1809776

PCB connector, nominal current: 12 A, rated voltage (III/2): 320 V, Nominal cross section: 2.5 mm², number of positions: 6, pitch: 5.08 mm, connection method: Crimp connection, color: green, Corresponding female crimp contacts with current [A] and conductor cross section range [mm²] data: 10A/MSTBC-MT 0,5-1,0 (3190564); 10A/MSTBC-MT 0,5-1,0 BA (3190645); 12A/MSTBC-MT 1,5-2,5 (3190551); 12A/MSTBC-MT 1,5-2,5 BA (3190658). BA = Bandkontakte

