

Printed-circuit board connector - DMC 1,5/20-G1F-3,5-LR P20THR - 1787195

Please be informed that the data shown in this PDF Document is generated from our Online Catalog. Please find the complete data in the user's documentation. Our General Terms of Use for Downloads are valid (<http://phoenixcontact.com/download>)

PCB headers, nominal current: 8 A, number of positions: 20, pitch: 3.5 mm, color: black, contact surface: Tin, mounting: THR soldering



The figure shows a 10-pos. version with 20 contacts

Your advantages

- ✓ Designed for integration into the SMT soldering process
- ✓ Screwable flange for superior mechanical stability
- ✓ Automatic locking and intuitive release through Lock and Release operating lever in contrasting color
- ✓ Conductor connection on several levels enables higher contact density
- ✓ Small component size for applications where space is at a premium

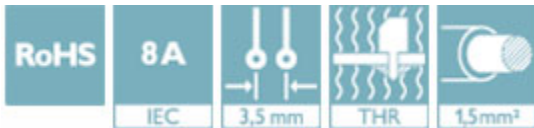

Key Commercial Data

Packing unit	1 pc
Minimum order quantity	50 pc
GTIN	 4 046356 596800
GTIN	4046356596800
Weight per Piece (excluding packing)	10.800 g
Custom tariff number	85366930
Country of origin	Germany

Technical data

Dimensions

Length [!]	11.6 mm
------------	---------

Printed-circuit board connector - DMC 1,5/20-G1F-3,5-LR P20THR - 1787195

Technical data

Dimensions

Width	77 mm
Pitch	3.5 mm
Dimension a	66.5 mm
Width [w]	77 mm
Height [h]	12.8 mm
Height	10.8 mm
Length of the solder pin	2 mm
Pin dimensions	0.8 x 0.8 mm
Pin spacing	2.50 mm
Length	11.6 mm

General

Range of articles	DMC 1,5/...-G1F-THR
Insulating material group	IIIa
Rated surge voltage (III/3)	2.5 kV
Rated surge voltage (III/2)	2.5 kV
Rated surge voltage (II/2)	2.5 kV
Rated voltage (III/3)	160 V
Rated voltage (III/2)	160 V
Rated voltage (II/2)	250 V
Connection in acc. with standard	EN-VDE
Nominal current I _N	8 A
Maximum load current	8 A
Insulating material	LCP
Flammability rating according to UL 94	V0
Color	black
Number of positions	20

Standards and Regulations

Connection in acc. with standard	EN-VDE
	CUL
Flammability rating according to UL 94	V0

Environmental Product Compliance

China RoHS	Environmentally friendly use period: unlimited = EFUP-e
	No hazardous substances above threshold values

Printed-circuit board connector - DMC 1,5/20-G1F-3,5-LR P20THR - 1787195

Drawings

Drilling diagram

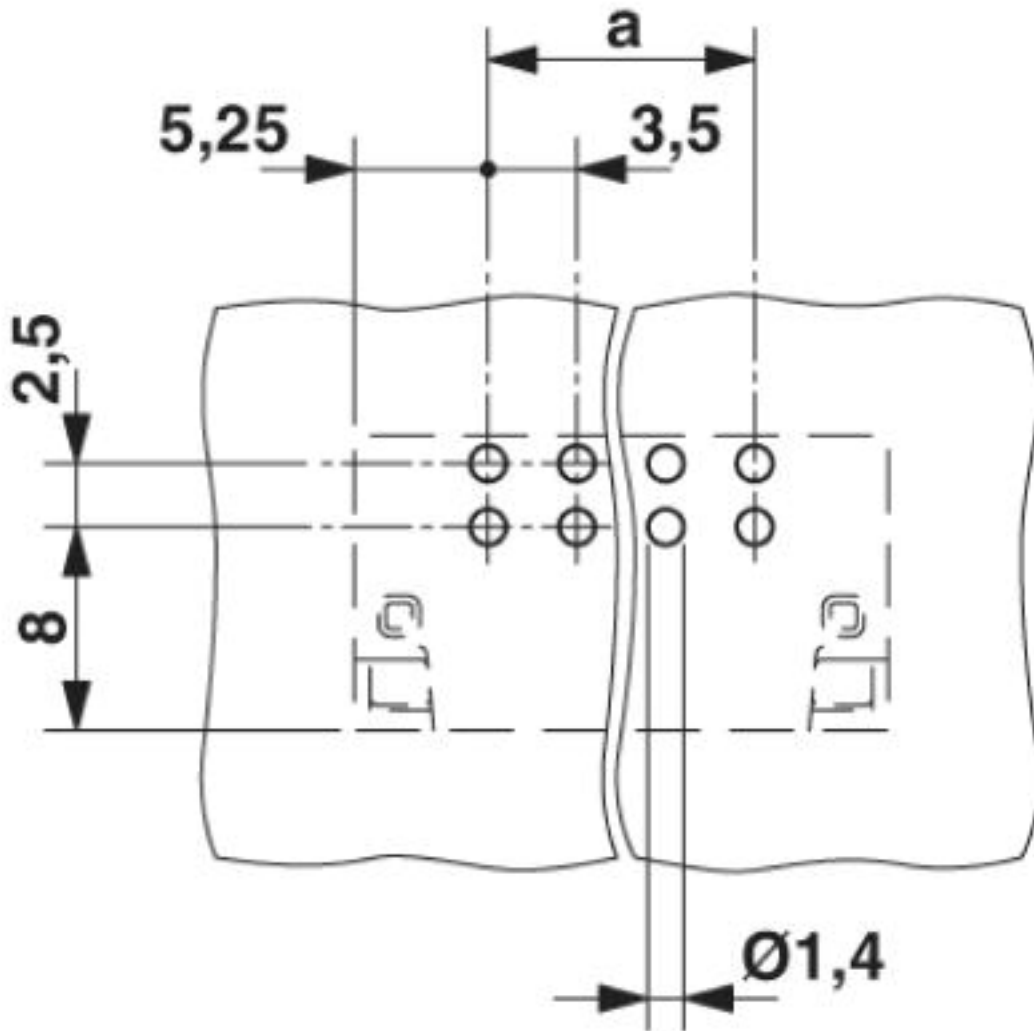

Printed-circuit board connector - DMC 1,5/20-G1F-3,5-LR P20THR - 1787195

Diagram

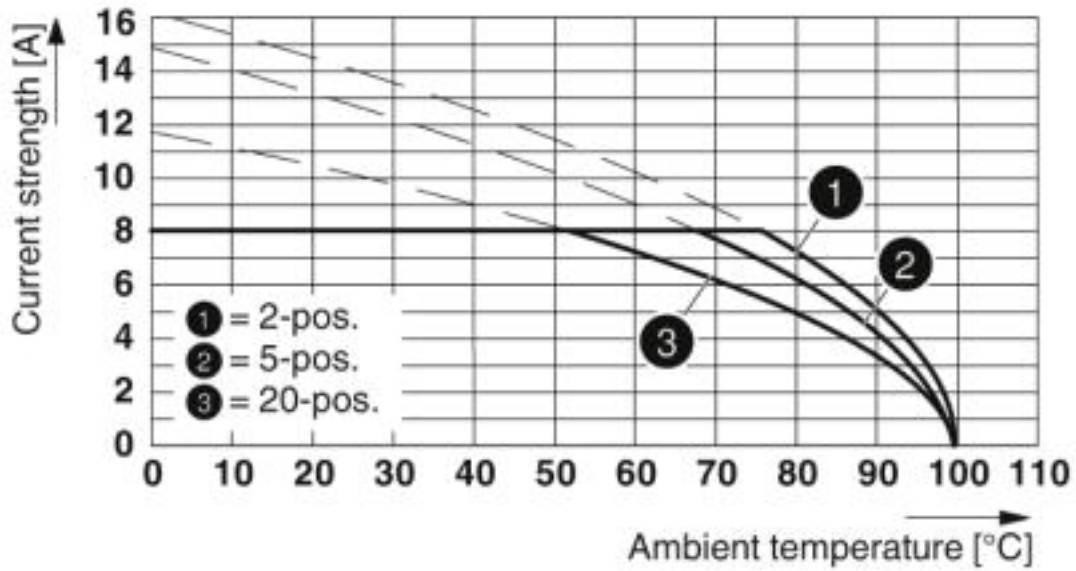

Type: DFMC 1,5/...-ST-3,5-LR with DMC 1,5/...-G1F-3,5-LR P20 THR

Dimensional drawing

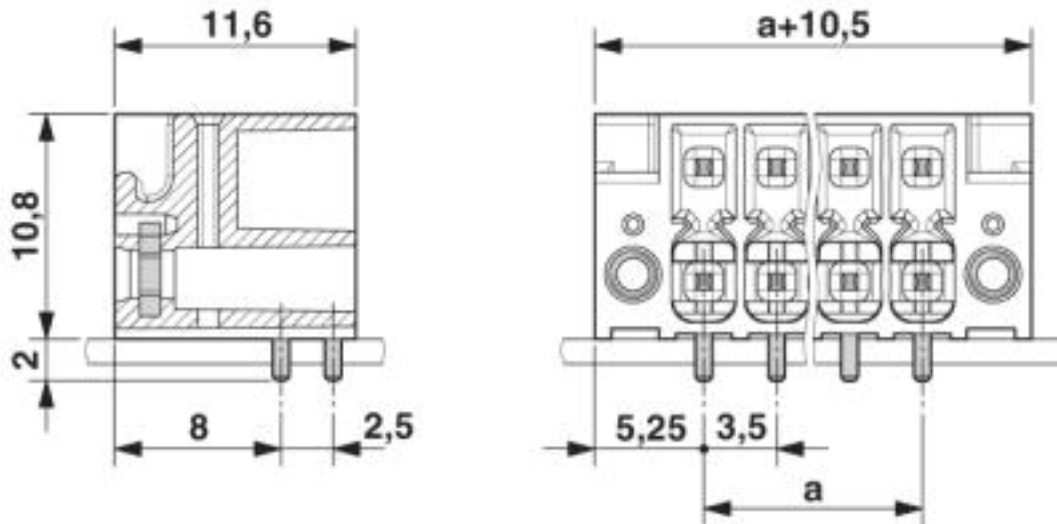

Printed-circuit board connector - DMC 1,5/20-G1F-3,5-LR P20THR - 1787195

Schematic diagram

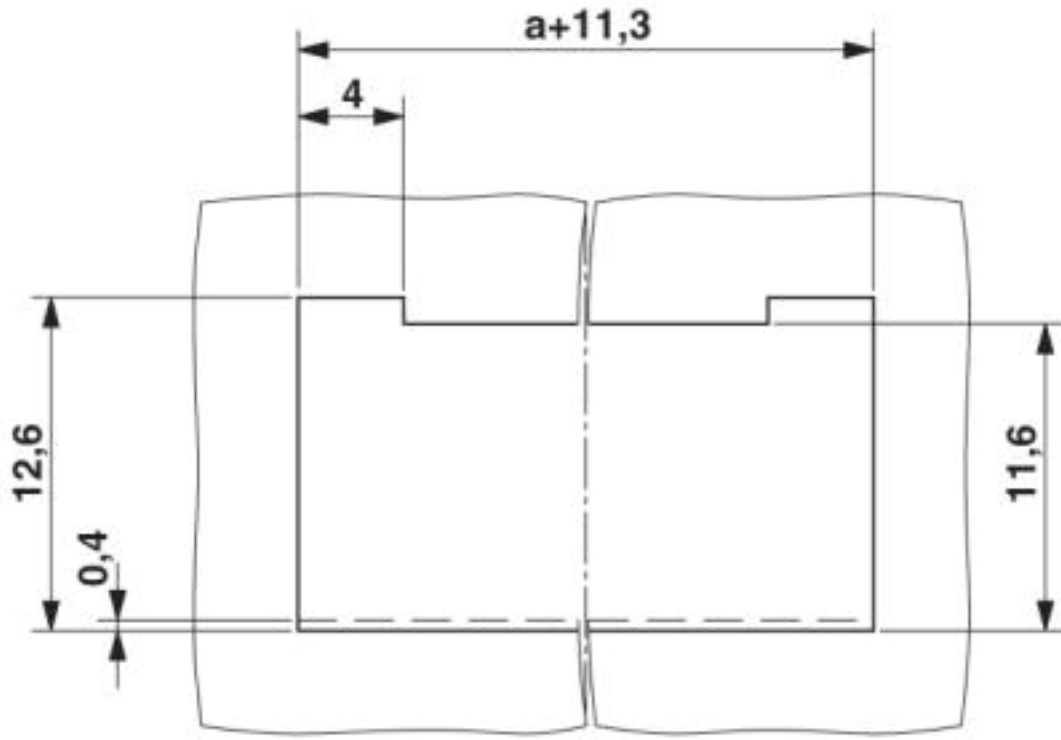

Panel cutout

Printed-circuit board connector - DMC 1,5/20-G1F-3,5-LR P20THR - 1787195

Schematic diagram

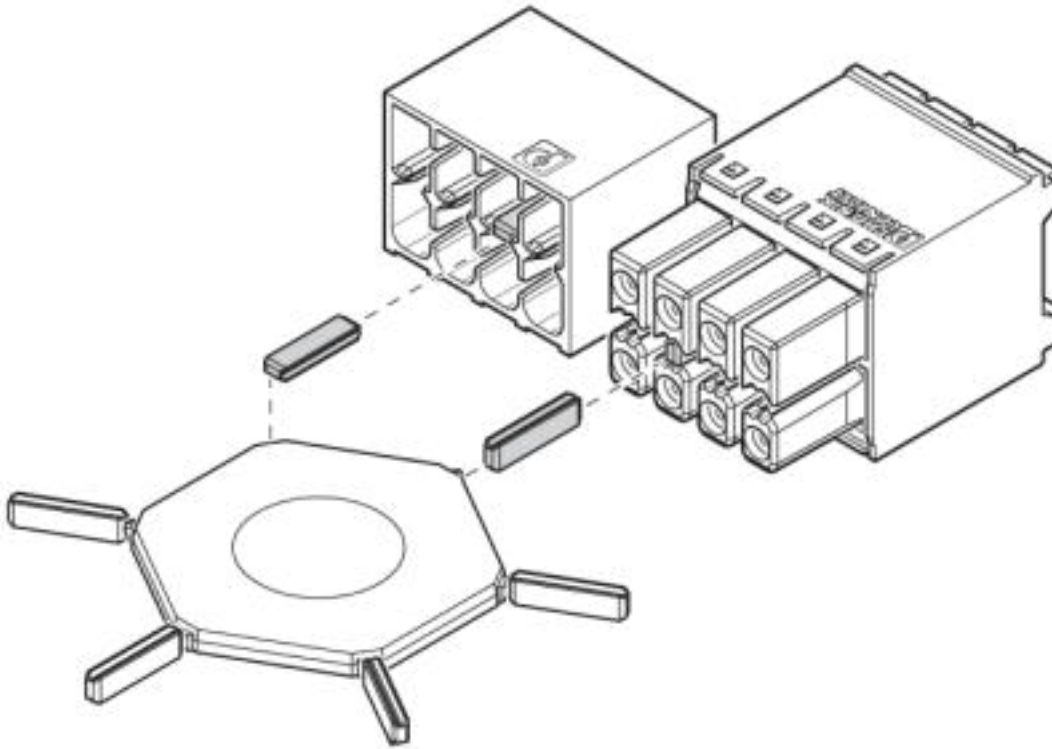

Use of the CP-DMC... coding profile

Classifications

eCl@ss

eCl@ss 4.0	27260700
eCl@ss 4.1	27260700
eCl@ss 5.0	27260700
eCl@ss 5.1	27260700
eCl@ss 6.0	27260700
eCl@ss 7.0	27440402
eCl@ss 8.0	27440402
eCl@ss 9.0	27440402

ETIM

ETIM 4.0	EC002637
ETIM 5.0	EC002637

Printed-circuit board connector - DMC 1,5/20-G1F-3,5-LR P20THR - 1787195

Classifications

ETIM

ETIM 6.0	EC002637
ETIM 7.0	EC002637

UNSPSC

UNSPSC 6.01	30211810
UNSPSC 7.0901	39121409
UNSPSC 11	39121409
UNSPSC 12.01	39121409
UNSPSC 13.2	39121409

Approvals

Approvals

Approvals

IECEE CB Scheme / VDE Gutachten mit Fertigungsüberwachung / EAC / cULus Recognized

Ex Approvals

Approval details

IECEE CB Scheme		http://www.iecee.org/	DE1-60359_B1_B2
Nominal voltage UN	160 V		
Nominal current IN	8 A		

VDE Gutachten mit Fertigungsüberwachung		http://www2.vde.com/de/Institut/Online-Service/VDE-gepruefteProdukte/Seiten/Online-Suche.aspx	40038423
Nominal voltage UN	160 V		
Nominal current IN	8 A		

Printed-circuit board connector - DMC 1,5/20-G1F-3,5-LR P20THR - 1787195

Approvals

EAC		B.01742
-----	--	---------

cULus Recognized		http://database.ul.com/cgi-bin/XYV/template/LISEXT/1FRAME/index.htm	E60425-20110128
	B	C	D
Nominal voltage UN	150 V	50 V	300 V
Nominal current IN	8 A	8 A	8 A

Accessories

Accessories

Coding element

Coding profile - CP-DMC 1,5 NAT - 1790647

Coding profile, for insertion between the coding ribs of the connector and the header following the reflow soldering process, insulating material, color: natural



Additional products

Printed-circuit board connector - DFMC 1,5/20-STF-3,5 - 1790470



Plug, nominal current: 8 A, rated voltage (III/2): 160 V, number of positions: 20 with 40 contacts, pitch: 3.5 mm, connection method: spring-cage connection, color: green, contact surface: tin

Printed-circuit board connector - DFMC 1,5/20-ST-3,5-LR - 1790661



Plug, nominal current: 8 A, rated voltage (III/2): 160 V, number of positions: 20 with 40 contacts, pitch: 3.5 mm, connection method: spring-cage connection, color: green, contact surface: tin

Printed-circuit board connector - DMC 1,5/20-G1F-3,5-LR P20THR - 1787195

Accessories

Phoenix Contact 2019 © - all rights reserved
<http://www.phoenixcontact.com>