

ISPC 5/12-STGCL-7,62 - PCB connector



1748969

<https://www.phoenixcontact.com/de/produkte/1748969>

Please be informed that the data shown in this PDF document is generated from our Online Catalog. Please find the complete data in the user documentation. Our General Terms of Use for Downloads are valid.



PCB connector, nominal cross section: 6 mm², color: green, nominal current: 41 A, rated voltage (III/2): 1000 V, contact surface: Tin, type of contact: Male connector, number of potentials: 12, number of rows: 1, number of positions: 12, number of connections: 12, product range: ISPC 5/..-STGCL, pitch: 7.62 mm, connection method: Push-in spring connection, conductor/PCB connection direction: 0 °, locking clip: - without locking clip, plug-in system: COMBICON PC 5, locking: Clip locking, mounting: Click & Lock latching window, type of packaging: packed in cardboard

Your advantages

- Time saving push-in connection, tools not required
- Defined contact force ensures that contact remains stable over the long term
- Clamping space opened by means of fixed screwdriver enables convenient conductor connection
- Inverted connector with pin contacts for touch-proof device outputs or free-hanging cable/cable connections
- Standard header – also suitable for connectors with automatically locking Click and Lock system
- 600 V UL approval in the smallest of dimensions

Commercial Data

Item number	1748969
Packing unit	50 pc
Minimum order quantity	50 pc
Sales Key	E1 - Leiterplattenanschl.
Product Key	AADFCA
Catalog Page	Page 534 (C-1-2013)
GTIN	4046356312615
Weight per Piece (including packing)	61 g
Weight per Piece (excluding packing)	58,7 g
Customs tariff number	85366990
Country of origin	IN

Technical Data

Product properties

Type	Inverted
Product line	COMBICON Connectors L
Product type	PCB plug
Product family	ISPC 5/...-STGCL
Number of positions	12
Pitch	7.62 mm
Number of connections	12
Number of rows	1
Mounting flange	Click & Lock latching window
Number of potentials	12

Electrical properties

Nominal current I_N	41 A
Nominal voltage U_N	1000 V
Degree of pollution	3
Contact resistance	0.55 mΩ
Rated voltage (III/3)	1000 V
Rated surge voltage (III/3)	8 kV
Rated voltage (III/2)	1000 V
Rated surge voltage (III/2)	8 kV
	1000 V
Rated surge voltage (II/2)	6 kV

Connection data

Connection technology

Type	Inverted
Connector system	COMBICON PC 5
Nominal cross section	6 mm ²
Type of contact	Male connector

Interlock

Locking type	Clip locking
Mounting flange	Click & Lock latching window

Conductor connection

Connection method	Push-in spring connection
Conductor/PCB connection direction	0 °
Conductor cross section solid	0.2 mm ² ... 10 mm ²
Conductor cross section flexible	0.2 mm ² ... 6 mm ²
Conductor cross section AWG	24 ... 8
Conductor cross section flexible, with ferrule without plastic	0.25 mm ² ... 6 mm ²

ISPC 5/12-STGCL-7,62 - PCB connector



1748969

<https://www.phoenixcontact.com/de/produkte/1748969>

sleeve	
Conductor cross section, flexible, with ferrule, with plastic sleeve	0.25 mm ² ... 4 mm ²
2 conductors with the same cross section, flexible, with TWIN ferrule with plastic sleeve	0.25 mm ² ... 1.5 mm ²
Cylindrical gauge a x b / diameter	4.3 mm x 4.0 mm / 4.0 mm
Stripping length	15 mm

Specifications for ferrules without insulating collar

recommended crimping tool	1212034 CRIMPFOX 6
ferrules without insulating collar, according to DIN 46228-1	Cross section: 0.5 mm ² ; Length: 10 mm ... 15 mm
	Cross section: 0.75 mm ² ; Length: 10 mm ... 15 mm
	Cross section: 1 mm ² ; Length: 10 mm ... 15 mm
	Cross section: 1.5 mm ² ; Length: 12 mm ... 15 mm
	Cross section: 2.5 mm ² ; Length: 12 mm ... 15 mm
	Cross section: 4 mm ² ; Length: 12 mm ... 15 mm
	Cross section: 6 mm ² ; Length: 12 mm ... 15 mm

Specifications for ferrules with insulating collar

recommended crimping tool	1212034 CRIMPFOX 6
ferrules with insulating collar, according to DIN 46228-4	Cross section: 0.5 mm ² ; Length: 10 mm ... 15 mm
	Cross section: 0.75 mm ² ; Length: 12 mm ... 15 mm
	Cross section: 1 mm ² ; Length: 12 mm ... 15 mm
	Cross section: 1.5 mm ² ; Length: 12 mm ... 15 mm
	Cross section: 2.5 mm ² ; Length: 12 mm ... 15 mm
	Cross section: 4 mm ² ; Length: 12 mm ... 15 mm

Material specifications

Material data - contact

Note	WEEE/RoHS-compliant, free of whiskers according to IEC 60068-2-82/JEDEC JESD 201
Contact material	Cu alloy
Surface characteristics	Tin-plated
Metal surface terminal point (top layer)	Tin (4 - 8 µm Sn)
Metal surface contact area (top layer)	Tin (4 - 8 µm Sn)

Material data - housing

Color (Housing)	green (6021)
Insulating material	PA
Insulating material group	I
CTI according to IEC 60112	600
Flammability rating according to UL 94	V0
Glow wire flammability index GWFI according to EN 60695-2-12	850
Glow wire ignition temperature GWIT according to EN 60695-2-13	775
Temperature for the ball pressure test according to EN 60695-10-2	125 °C

ISPC 5/12-STGCL-7,62 - PCB connector



1748969

<https://www.phoenixcontact.com/de/produkte/1748969>

Material data – actuating element

Color ()	()
----------	----

Dimensions

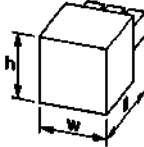
Dimensional drawing	
Pitch	7.62 mm
Width [w]	94.24 mm
Height [h]	19.8 mm
Length [l]	40.5 mm

Notes

Notes on operation	In accordance with IEC 61984, COMBICON connectors have no switching power (COC). During designated use, they must not be plugged in or disconnected when carrying voltage or under load.
--------------------	--

Mechanical tests

Test for conductor damage and slackening

Specification	IEC 60999-1:1999-11
Result	Test passed

Repeated connection and disconnection

Specification	IEC 60999-1:1999-11
Result	Test passed

Pull-out test

Specification	IEC 60999-1:1999-11
Conductor cross section/conductor type/tractive force setpoint/actual value	10 mm ² / solid / > 90 N
	6 mm ² / flexible / > 80 N
	0.2 mm ² / solid / > 10 N
	0.2 mm ² / flexible / > 10 N

Insertion and withdrawal forces

Result	Test passed
No. of cycles	25
Insertion strength per pos. approx.	7.5 N
Withdraw strength per pos. approx.	5 N

Resistance of inscriptions

Specification	IEC 60068-2-70:1995-12
Result	Test passed

1748969

<https://www.phoenixcontact.com/de/produkte/1748969>

Polarization and coding

Specification	IEC 60512-7:1993-08 (Polarization)
Result	Test passed

Visual inspection

Specification	IEC 60512-1-1:2002-02
Result	Test passed

Dimension check

Specification	IEC 60512-1-2:2002-02
Result	Test passed

Environmental and real-life conditions

Vibration test

Specification	IEC 60068-2-6:1995-03
Frequency	10 - 150 - 10 Hz
Sweep speed	1 octave/min
Amplitude	0.35 mm (10 Hz ... 60.1 Hz)
Sweep speed	5g (60.1 Hz ... 150 Hz)
Test duration per axis	2.5 h

Durability test

Specification	IEC 60512-5:1992-08
Impulse withstand voltage at sea level	9.8 kV
Contact resistance R_1	0.55 m Ω
Contact resistance R_2	0.6 m Ω
Insertion/withdrawal cycles	25

Climatic test

Specification	ISO 6988:1985-02
Corrosive stress	0.2 dm ³ SO ₂ on 300 dm ³ /40 °C/1 cycle
Thermal stress	100 °C/168 h
Power-frequency withstand voltage	4.26 kV

Ambient conditions

Ambient temperature (operation)	-40 °C ... 100 °C (dependent on the derating curve)
Ambient temperature (storage/transport)	-40 °C ... 70 °C
Relative humidity (storage/transport)	30 % ... 70 %
Ambient temperature (assembly)	-5 °C ... 100 °C

Electrical tests

Thermal test | Test group C

Specification	IEC 60512-5-1:2002-02
Tested number of positions	12

ISPC 5/12-STGCL-7,62 - PCB connector



1748969

<https://www.phoenixcontact.com/de/produkte/1748969>

Insulation resistance

Specification	IEC 60512-3-1:2002-02
Insulation resistance, neighboring positions	$10^{12} \Omega$

Temperature cycles

Specification	IEC 60999-1:1999-11
---------------	---------------------

Air clearances and creepage distances |

Specification	IEC 60664-1:2007-04
Insulating material group	I
Comparative tracking index (IEC 60112)	CTI 600
Rated insulation voltage (III/3)	1000 V
Rated surge voltage (III/3)	8 kV
minimum clearance value - non-homogenous field (III/3)	8 mm
minimum creepage distance (III/3)	12.5 mm
Rated insulation voltage (III/2)	1000 V
Rated surge voltage (III/2)	8 kV
minimum clearance value - non-homogenous field (III/2)	8 mm
minimum creepage distance (III/2)	8 mm
Rated insulation voltage (II/2)	1000 V
Rated surge voltage (II/2)	6 kV
minimum clearance value - non-homogenous field (II/2)	5.5 mm
minimum creepage distance (II/2)	5.5 mm

Packaging specifications

Type of packaging	packed in cardboard
-------------------	---------------------

Drawings

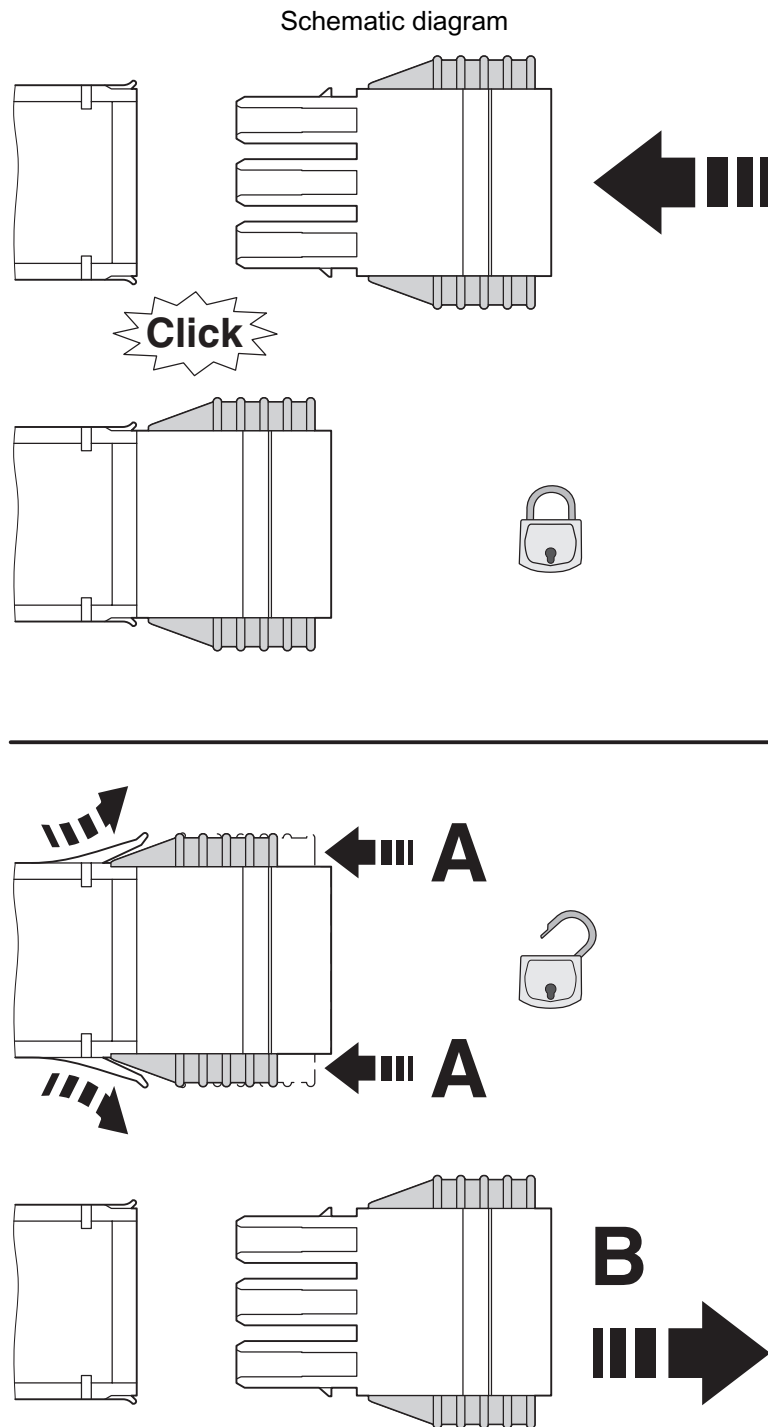

Click and Lock system method of operation

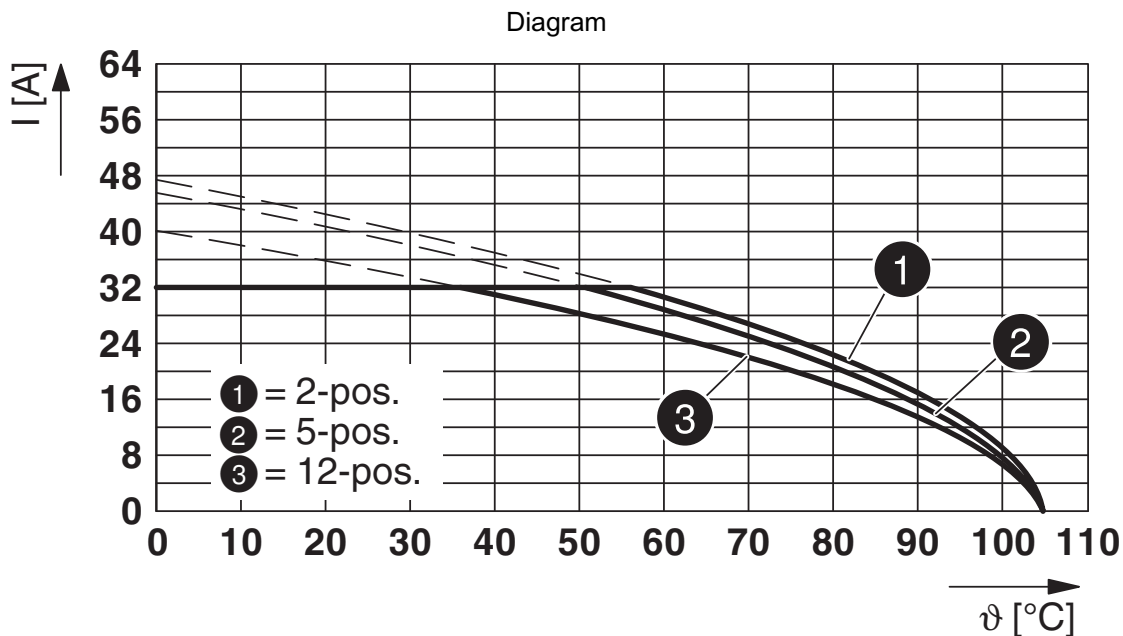

Type: PC 5/...-STCL1-7,62 with ISPC 5/...-STGCL-7,62

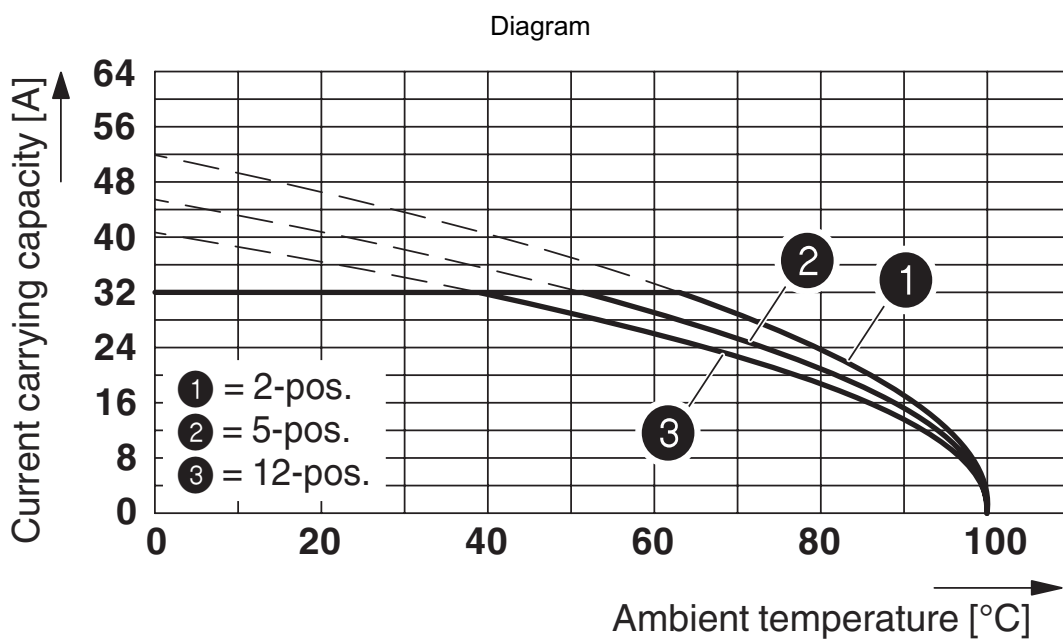

Type: ISPC 5/...-STGCL-7,62 with IPC 5/...-G-7,62

1748969

<https://www.phoenixcontact.com/de/produkte/1748969>

Diagram

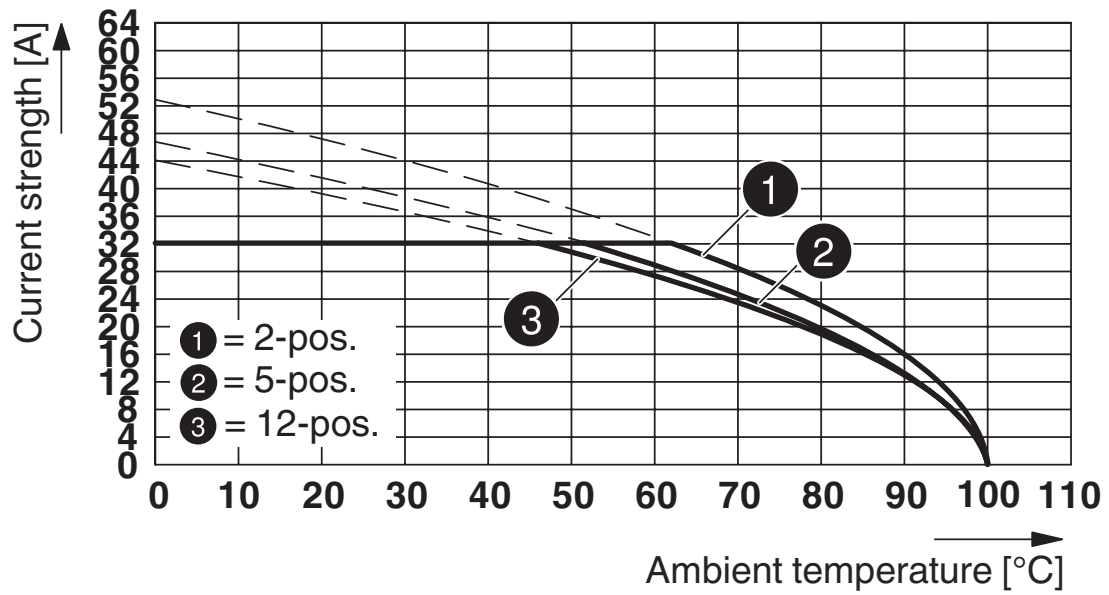

Type: SPC 5/...-STCL-7,62 with ISPC 5/...-STGCL-7,62

ISPC 5/12-STGCL-7,62 - PCB connector



1748969

<https://www.phoenixcontact.com/de/produkte/1748969>

Approvals



EAC

Approval ID: B.01687



cULus Recognized

Approval ID: E60425-19920722

	Nominal Voltage U_N	Nominal Current I_N	Cross Section AWG	Cross Section mm^2
Use group B				
	600 V	35 A	24 - 8	-
Use group C				
	600 V	35 A	24 - 8	-

ISPC 5/12-STGCL-7,62 - PCB connector



1748969

<https://www.phoenixcontact.com/de/produkte/1748969>

Classifications

ECLASS

ECLASS-9.0	27440309
ECLASS-10.0.1	27440309
ECLASS-11.0	27460202

ETIM

ETIM 8.0	EC002638
----------	----------

UNSPSC

UNSPSC 21.0	39121400
-------------	----------

ISPC 5/12-STGCL-7,62 - PCB connector



1748969

<https://www.phoenixcontact.com/de/produkte/1748969>

Environmental Product Compliance

China RoHS	Environmentally friendly use period: unlimited = EFUP-e
	No hazardous substances above threshold values

ISPC 5/12-STGCL-7,62 - PCB connector

1748969

<https://www.phoenixcontact.com/de/produkte/1748969>

Accessories

CP-PC RD - Coding profile

1701967

<https://www.phoenixcontact.com/de/produkte/1701967>

Coding profile, for plugging into the coding ribs of the plug at a later date, insulating material, color: Red



SZF 1-0,6X3,5 - Screwdriver

1204517

<https://www.phoenixcontact.com/de/produkte/1204517>

Actuation tool, for ST terminal blocks, also suitable for use as a bladed screwdriver, size: 0.6 x 3.5 x 100 mm, 2-component grip, with non-slip grip



ISPC 5/12-STGCL-7,62 - PCB connector

1748969

<https://www.phoenixcontact.com/de/produkte/1748969>

CRIMPFOX 6 - Crimping pliers

1212034

<https://www.phoenixcontact.com/de/produkte/1212034>



Crimping pliers, for ferrules without insulating collar according to DIN 46228 Part 1 and ferrules with insulating collar according to DIN 46228 Part 4, 0.25 mm² ... 6.0 mm², lateral entry, trapezoidal crimp

SK 7,62/3,8:FORTL.ZAHLEN - Marker card

0804549

<https://www.phoenixcontact.com/de/produkte/0804549>

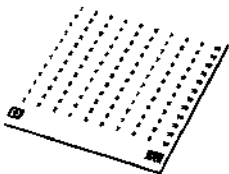

Marker card, white, labeled, horizontal: consecutive numbers 1 ... 10, 11 ... 20, etc. up to 91 ... 100, mounting type: adhesive, for terminal block width: 7.62 mm, lettering field size: 7.62 x 3.8 mm

ISPC 5/12-STGCL-7,62 - PCB connector

1748969

<https://www.phoenixcontact.com/de/produkte/1748969>

SK 3,8 REEL P7,62 WH CUS - Marker card

0825128

<https://www.phoenixcontact.com/de/produkte/0825128>

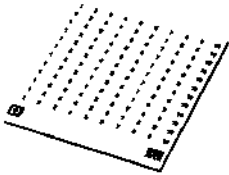

Marker card, can be ordered: by card, white, labeled according to customer specifications, mounting type: adhesive, for terminal block width: 7.62 mm, lettering field size: continuous x 3.8 mm

SK U/3,8 WH:UNBEDRUCKT - Marker card

0803906

<https://www.phoenixcontact.com/de/produkte/0803906>



Marker card, Sheet, white, unlabeled, can be labeled with: PLOTMARK, CMS-P1-PLOTTER, Office printing systems, mounting type: adhesive, for terminal block width: 210 mm, lettering field size: 186 x 3.8 mm, Number of individual labels: 1440

ISPC 5/12-STGCL-7,62 - PCB connector

1748969

<https://www.phoenixcontact.com/de/produkte/1748969>

SK 3,8 WH:REEL - Marker strip

0805218

<https://www.phoenixcontact.com/de/produkte/0805218>



Marker strip, Roll, white, unlabeled, can be labeled with: THERMOMARK E.300 (D)/600 (D), THERMOMARK ROLL 2.0, THERMOMARK ROLL, THERMOMARK ROLL X1, THERMOMARK ROLLMaster 300/600, THERMOMARK X1.2, mounting type: adhesive, for terminal block width: 90000 mm, lettering field size: continuous x 3.8 mm, Number of individual labels: 210000

PC 5/12-ST1-7,62 - PCB connector

1777820

<https://www.phoenixcontact.com/de/produkte/1777820>



PCB connector, nominal cross section: 6 mm², color: green, nominal current: 41 A, rated voltage (III/2): 1000 V, contact surface: Tin, type of contact: Female connector, number of potentials: 12, number of rows: 1, number of positions: 12, number of connections: 12, product range: PC 5/...-ST1, pitch: 7.62 mm, connection method: Screw connection with tension sleeve, screw head form: L Slotted, conductor/PCB connection direction: 0 °, locking clip: - Locking clip, plug-in system: COMBICON PC 5, locking: without, mounting: without, type of packaging: packed in cardboard

ISPC 5/12-STGCL-7,62 - PCB connector

1748969

<https://www.phoenixcontact.com/de/produkte/1748969>

PC 5/12-STCL1-7,62 - PCB connector

1778162

<https://www.phoenixcontact.com/de/produkte/1778162>



PCB connector, nominal cross section: 6 mm², color: green, nominal current: 41 A, rated voltage (III/2): 1000 V, contact surface: Tin, type of contact: Female connector, number of potentials: 12, number of rows: 1, number of positions: 12, number of connections: 12, product range: PC 5/...-STCL1, pitch: 7.62 mm, connection method: Screw connection with tension sleeve, screw head form: Z1L Slotted Pozidriv, conductor/PCB connection direction: 0 °, locking clip: - without locking clip, plug-in system: COMBICON PC 5, locking: Clip locking, mounting: Click & Lock latching slide, type of packaging: packed in cardboard

SPC 5/12-ST-7,62 - PCB connector

1996113

<https://www.phoenixcontact.com/de/produkte/1996113>



PCB connector, nominal cross section: 6 mm², color: green, nominal current: 41 A, rated voltage (III/2): 1000 V, contact surface: Tin, type of contact: Female connector, number of potentials: 12, number of rows: 1, number of positions: 12, number of connections: 12, product range: SPC 5/...-ST, pitch: 7.62 mm, connection method: Push-in spring connection, conductor/PCB connection direction: 0 °, locking clip: - Locking clip, plug-in system: COMBICON PC 5, locking: without, mounting: without, type of packaging: packed in cardboard

ISPC 5/12-STGCL-7,62 - PCB connector

1748969

<https://www.phoenixcontact.com/de/produkte/1748969>

SPC 5/12-STCL-7,62 - PCB connector

1718588

<https://www.phoenixcontact.com/de/produkte/1718588>



PCB connector, nominal cross section: 6 mm², color: green, nominal current: 41 A, rated voltage (III/2): 1000 V, contact surface: Tin, type of contact: Female connector, number of potentials: 12, number of rows: 1, number of positions: 12, number of connections: 12, product range: SPC 5/..-STCL, pitch: 7.62 mm, connection method: Push-in spring connection, conductor/PCB connection direction: 0 °, locking clip: - without locking clip, plug-in system: COMBICON PC 5, locking: Clip locking, mounting: Click & Lock latching slide, type of packaging: packed in cardboard

TSPC 5/12-ST-7,62 - PCB connector

1728552

<https://www.phoenixcontact.com/de/produkte/1728552>



PCB connector, nominal cross section: 6 mm², color: green, nominal current: 41 A, rated voltage (III/2): 1000 V, contact surface: Tin, type of contact: Female connector, number of potentials: 12, number of rows: 1, number of positions: 12, number of connections: 24, product range: TSPC 5/..-ST, pitch: 7.62 mm, connection method: Push-in spring connection, conductor/PCB connection direction: 0 °, locking clip: - Locking clip, plug-in system: COMBICON PC 5, locking: without, mounting: without, type of packaging: packed in cardboard

ISPC 5/12-STGCL-7,62 - PCB connector

1748969

<https://www.phoenixcontact.com/de/produkte/1748969>



TSPC 5/12-STCL-7,62 - PCB connector

1765515

<https://www.phoenixcontact.com/de/produkte/1765515>



PCB connector, nominal cross section: 6 mm², color: green, nominal current: 41 A, rated voltage (III/2): 1000 V, contact surface: Tin, type of contact: Female connector, number of potentials: 12, number of rows: 1, number of positions: 12, number of connections: 24, product range: TSPC 5/...-STCL, pitch: 7.62 mm, connection method: Push-in spring connection, conductor/PCB connection direction: 0 °, locking clip: - without locking clip, plug-in system: COMBICON PC 5, locking: Clip locking, mounting: Click & Lock latching slide, type of packaging: packed in cardboard

IPC 5/12-G-7,62 - PCB header

1708488

<https://www.phoenixcontact.com/de/produkte/1708488>



PCB headers, nominal cross section: 6 mm², color: green, nominal current: 41 A, rated voltage (III/2): 630 V, contact surface: Tin, type of contact: Female connector, number of potentials: 12, number of rows: 1, number of positions: 12, number of connections: 12, product range: IPC 5/...-G, pitch: 7.62 mm, mounting: Wave soldering, pin layout: Linear pinning, solder pin [P]: 5 mm, number of solder pins per potential: 3, plug-in system: COMBICON PC 5, Pin connector pattern alignment: Standard, locking: without, mounting: without, type of packaging: packed in cardboard

ISPC 5/12-STGCL-7,62 - PCB connector



1748969

<https://www.phoenixcontact.com/de/produkte/1748969>

IPC 5/12-GU-7,62 - PCB header

1708705

<https://www.phoenixcontact.com/de/produkte/1708705>



PCB headers, nominal cross section: 6 mm², color: green, nominal current: 41 A, rated voltage (III/2): 630 V, contact surface: Tin, type of contact: Female connector, number of potentials: 12, number of rows: 1, number of positions: 12, number of connections: 12, product range: IPC 5/..-GU, pitch: 7.62 mm, mounting: Wave soldering, pin layout: Linear pinning, solder pin [P]: 5 mm, number of solder pins per potential: 3, plug-in system: COMBICON PC 5, Pin connector pattern alignment: reversed, locking: without, mounting: without, type of packaging: packed in cardboard

IPCV 5/12-G-7,62 - PCB header

1708925

<https://www.phoenixcontact.com/de/produkte/1708925>



PCB headers, nominal cross section: 6 mm², color: green, nominal current: 41 A, rated voltage (III/2): 630 V, contact surface: Tin, type of contact: Female connector, number of potentials: 12, number of rows: 1, number of positions: 12, number of connections: 12, product range: IPCV 5/..-G, pitch: 7.62 mm, mounting: Wave soldering, pin layout: Linear pinning, solder pin [P]: 5 mm, number of solder pins per potential: 3, plug-in system: COMBICON PC 5, Pin connector pattern alignment: Standard, locking: without, mounting: without, type of packaging: packed in cardboard

Phoenix Contact 2023 © - all rights reserved
<https://www.phoenixcontact.com>

PHOENIX CONTACT Deutschland GmbH
Flachsmarktstraße 8
D-32825 Blomberg
+49 52 35/3-1 20 00
info@phoenixcontact.de