

Sensor/actuator cable - SAC-3P-M12MS/ 0,6-PUR/M12FR - 1681554

Please be informed that the data shown in this PDF Document is generated from our Online Catalog. Please find the complete data in the user's documentation. Our General Terms of Use for Downloads are valid (<http://phoenixcontact.com/download>)



Sensor/actuator cable, 3-position, PUR halogen-free, black-gray RAL 7021, Plug straight M12, A-coded, on Socket angled M12, A-coded, cable length: 0.6 m

Your advantages

- ✓ Easy and safe: 100% electrically tested plug-in components
- ✓ Our standard: robust halogen-free PUR cable

Key Commercial Data

Packing unit	1 pc
GTIN	 4 017918 158163
GTIN	4017918158163
Weight per Piece (excluding packing)	33.400 g
Custom tariff number	85444290
Country of origin	Germany

Technical data

Dimensions

Length of cable	0.6 m
-----------------	-------

Ambient conditions

Ambient temperature (operation)	-25 °C ... 90 °C (Plug / socket)
Degree of protection	IP65
	IP67
	IP68

General

Sensor/actuator cable - SAC-3P-M12MS/ 0,6-PUR/M12FR - 1681554

Technical data

General

Rated current at 40°C	4 A
Rated voltage	250 V AC
	250 V DC
Number of positions	3
Insulation resistance	≥ 100 MΩ
Coding	A - standard
Standards/regulations	M12 connector IEC 61076-2-101
Status display	No
Protective circuit/component	unwired
Overvoltage category	II
Degree of pollution	3
Insertion/withdrawal cycles	≥ 100
Torque	0.4 Nm (M12 connector)

Material

Flammability rating according to UL 94	HB
Contact material	CuSn
Contact surface material	Ni/Au
Contact carrier material	TPU GF
Material of grip body	TPU, hardly inflammable, self-extinguishing
Material, knurls	Zinc die-cast, nickel-plated
Sealing material	NBR

Standards and Regulations

Standard designation	M12 connector
Standards/regulations	IEC 61076-2-101
Flammability rating according to UL 94	HB

Cable

Cable type	PUR halogen-free black
Cable type (abbreviation)	PUR
Cable abbreviation	Li9Y11Y
UL AWM style	20549
Conductor cross section	3x 0.34 mm ² (Signal line)
AWG signal line	22
Conductor structure signal line	42x 0.10 mm
Core diameter including insulation	1.27 mm ±0.02 mm (Signal line)
Thickness, insulation	≥ 0.21 mm (Core insulation)
	approx. 0.5 mm (Outer cable sheath)

Sensor/actuator cable - SAC-3P-M12MS/ 0,6-PUR/M12FR - 1681554

Technical data

Cable

Wire colors	brown, blue, black
Overall twist	3 wires, twisted
External sheath, color	black-gray RAL 7021
External cable diameter D	3.85 mm ±0.15 mm
Smallest bending radius, fixed installation	19 mm
Smallest bending radius, movable installation	38 mm
Number of bending cycles	10000000
Bending radius	44 mm
Traversing path	10 m
Traversing rate	3 m/s
Acceleration	10 m/s ²
Cable weight	23 kg/km
Outer sheath, material	PUR
Material conductor insulation	PP
Conductor material	Bare Cu litz wires
Insulation resistance	≥ 100 GΩ*km (at 20 °C)
Conductor resistance	max. 58 Ω/km (at 20 °C)
Nominal voltage, cable	≤ 300 V
Test voltage, cable	≥ 3000 V
Special properties	Flexible cable conduit capable
	Silicone-free
	Free of substances which would hinder coating with paint or varnish
Flame resistance	in accordance with UL 758/1581 FT2
	DIN EN 60332-2-2 (20 s)
Halogen-free	in accordance with DIN VDE 0472 part 815
Resistance to oil	in accordance with DIN EN 60811-2-1
Other resistance	Highly resistant to acids, alkaline solutions and solvents
	hydrolysis and microbe resistant
	partly UV-resistant in accordance with DIN EN ISO 4892-2-A
Ambient temperature (operation)	-40 °C ... 80 °C (cable, fixed installation)
	-25 °C ... 80 °C (cable, flexible installation)

Environmental Product Compliance

China RoHS	Environmentally friendly use period: unlimited = EFUP-e
	No hazardous substances above threshold values

Drawings

Sensor/actuator cable - SAC-3P-M12MS/ 0,6-PUR/M12FR - 1681554

Dimensional drawing

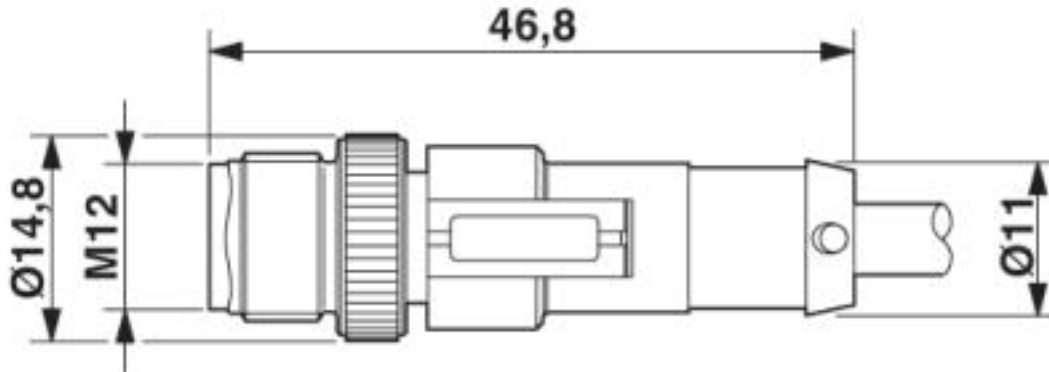

Plug, M12 x 1, straight, shielded

Sensor/actuator cable - SAC-3P-M12MS/ 0,6-PUR/M12FR - 1681554

Dimensional drawing

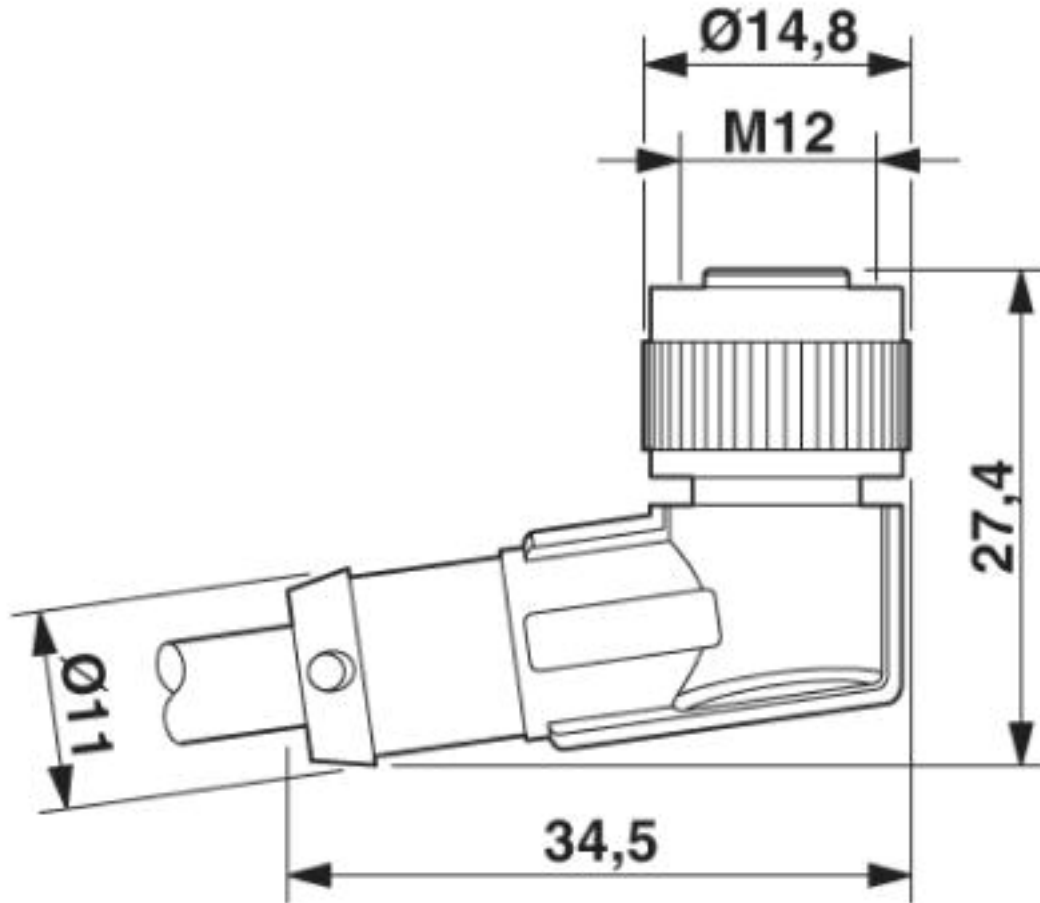

M12 x 1 socket, angled

Circuit diagram

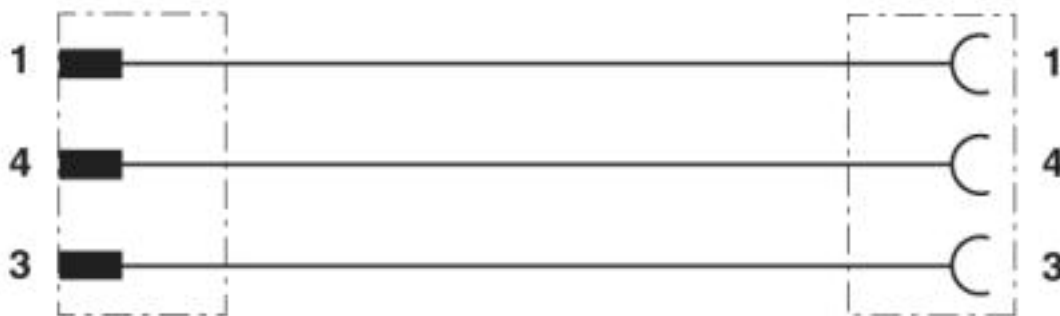

Contact assignment of the M12 plug and the M12 socket

Sensor/actuator cable - SAC-3P-M12MS/ 0,6-PUR/M12FR - 1681554

Schematic diagram

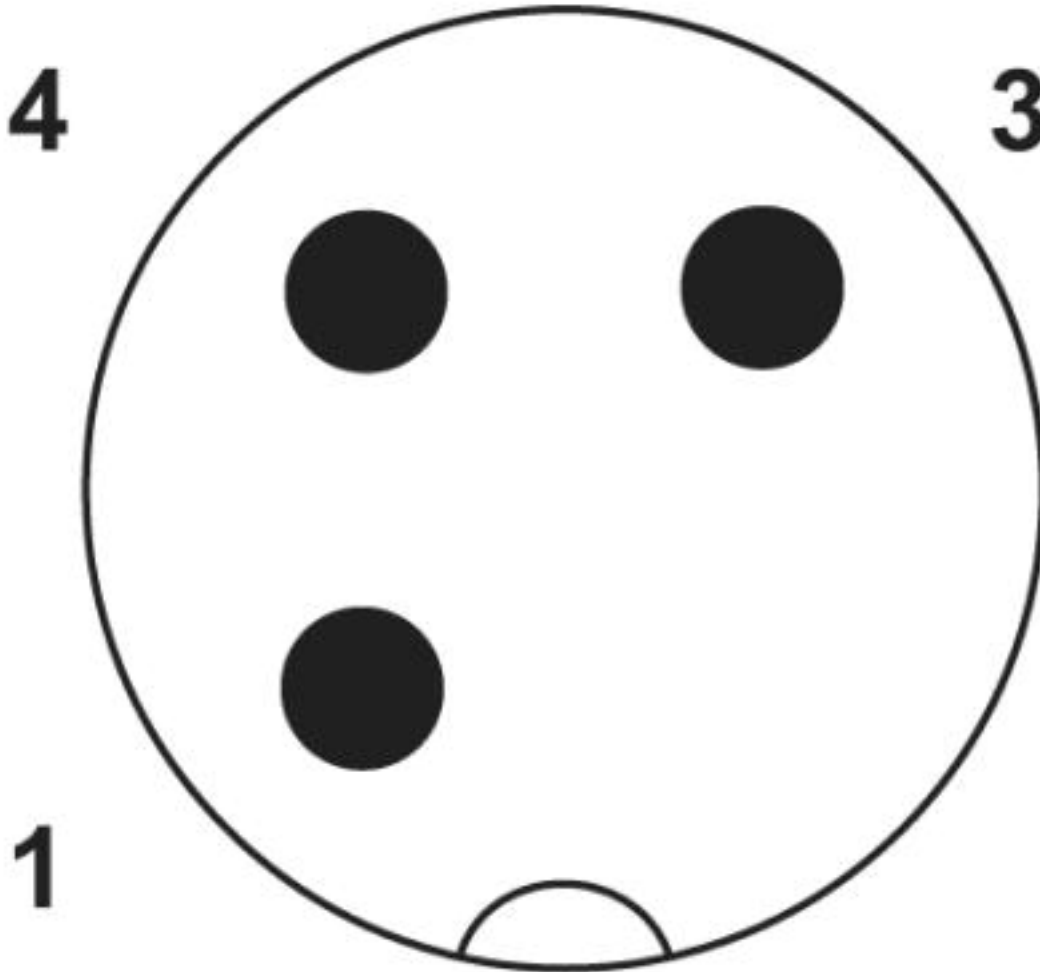

Pin assignment M12 plug, 3-pos., A-coded, view male side

Sensor/actuator cable - SAC-3P-M12MS/ 0,6-PUR/M12FR - 1681554

Schematic diagram

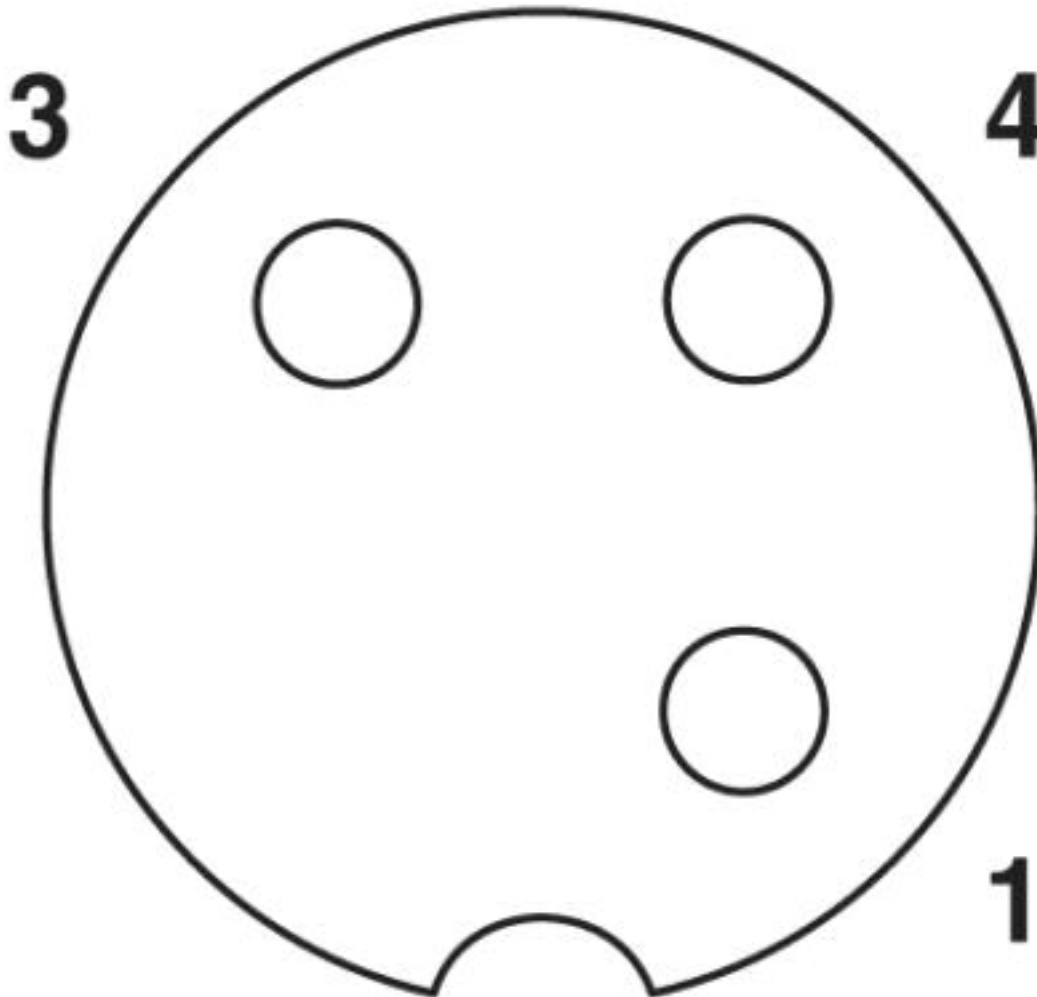

Pin assignment M12 socket, 3-pos., A-coded, view female side

Classifications

eCl@ss

eCl@ss 4.0	27060300
eCl@ss 4.1	27060300
eCl@ss 5.0	27061800
eCl@ss 5.1	27061800
eCl@ss 6.0	27279200
eCl@ss 7.0	27279218

Sensor/actuator cable - SAC-3P-M12MS/ 0,6-PUR/M12FR - 1681554

Classifications

eCl@ss

eCl@ss 8.0	27279218
eCl@ss 9.0	27060311

ETIM

ETIM 2.0	EC000830
ETIM 3.0	EC001855
ETIM 4.0	EC001855
ETIM 5.0	EC001855
ETIM 6.0	EC001855
ETIM 7.0	EC001855

UNSPSC

UNSPSC 6.01	31251501
UNSPSC 7.0901	31251501
UNSPSC 11	31251501
UNSPSC 12.01	31251501
UNSPSC 13.2	31251501

Approvals

Approvals

Approvals

UL Listed / cUL Listed / EAC / cULus Listed

Ex Approvals

Approval details

UL Listed		http://database.ul.com/cgi-bin/XYV/template/LISEXT/1FRAME/index.htm	FILE E 221474
Nominal voltage UN	300 V		
Nominal current IN	4 A		

Sensor/actuator cable - SAC-3P-M12MS/ 0,6-PUR/M12FR - 1681554

Approvals

cUL Listed		http://database.ul.com/cgi-bin/XYV/template/LISEXT/1FRAME/index.htm	FILE E 221474
Nominal voltage UN		300 V	
Nominal current IN		4 A	

EAC		RU C- DE.BL08.B.00286
-----	--	--------------------------

cULus Listed	
--------------	--

Accessories

Accessories

Conductor marking

Insert label - PABA WH/23 - 1013779



Insert label, Strip, white, unlabeled, can be labeled with: CMS-P1-PLOTTER, mounting type: thread on, cable diameter range: 1.5 ... 35 mm, lettering field size: 23 x 4 mm, Number of individual labels: 20

Insert label - PABA YE/23 - 1013782



Insert label, Strip, yellow, unlabeled, can be labeled with: CMS-P1-PLOTTER, mounting type: thread on, cable diameter range: 1.5 ... 35 mm, lettering field size: 23 x 4 mm, Number of individual labels: 20

Marker pen

Sensor/actuator cable - SAC-3P-M12MS/ 0,6-PUR/M12FR - 1681554

Accessories

Marker pen - B-STIFT - 1051993



Marker pen, for manual labeling of unprinted Zack strips, smear-proof and waterproof, line thickness 0.5 mm

Protective cap

Sealing cap - PROT-M12 FS-PA-CHAIN - 1430873



M12 sealing cap made of plastic with fixing band, for sensor cables, for free M12 plugs

Screw plug - PROT-M12 MS-PA-CHAIN - 1430899



M12 sealing cap with fixing band, for sensor cables, for free M12 sockets

Safety locking

Locking clip - SAC-M12-EXCLIP-M - 1558988



Locking clip for the pin side of sensor/actuator cables with M12 connector and M12 connectors for assembly, for knurl diameter: 15 mm or for Allen key with a wrench size of 14 mm, prevents the disconnection of plug-in connections without tools

Locking clip - SAC-M12-EXCLIP-F - 1558991



Locking clip for the socket side of sensor/actuator cables with M12 connector and M12 connectors for assembly, for knurl diameter: 15 mm or for Allen key with a wrench size of 14 mm, prevents the disconnection of plug-in connections without tools

Sensor/actuator cable - SAC-3P-M12MS/ 0,6-PUR/M12FR - 1681554

Accessories

Screwdriver tools

Adapter insert - TSD-M SAC-BIT ADAPTER - 1212600



Adapter bit for TSD-M...torque tools, E6.3-1/4" drive with 4 mm hexagon to accommodate SAC bits

Tool - SAC BIT M12-D15 - 1208432



Nut for assembling sensor/actuator cables with M12 connector and M12 connectors for assembly, with a knurl diameter of 15 mm, for 4 mm hexagonal drive

Torque tool

Torque screwdriver - TSD 04 SAC - 1208429



Torque screwdriver, with preset torque of 0.4 Nm and 4 mm hexagonal drive for M12 connectors

Torque screwdriver - TSD-M 1,2NM - 1212224



Torque screw driver, accuracy as per EN ISO 6789 standard, adjustable from 0.3 - 1.2 Nm
