

Cable connector - ST-17S1N8A8K02S



1613288

<https://www.phoenixcontact.com/pc/products/1613288>

Please be informed that the data shown in this PDF document is generated from our Online Catalog. Please find the complete data in the user documentation. Our General Terms of Use for Downloads are valid.



Cable connector, straight, SPEEDCON locking, M17, number of positions: 17, type of contact: Socket, shielded: yes, degree of protection: IP67, cable diameter range: 3.5 mm ... 5.5 mm, number of positions: 17, connection method: Crimp connection, series: ST

Your advantages

- Reduced size: ideal for compact devices
- Consistent EMC protection for reliable connection solutions in the industrial environment
- Crimping connection: vibration- and temperature-resistant assembly
- Flexible use: reliably connect various cable diameters

Cable connector - ST-17S1N8A8K02S



1613288

<https://www.phoenixcontact.com/pc/products/1613288>

Commercial Data

Item number	1613288
Packing unit	1 pc
Minimum order quantity	1 pc
Note	Made to Order (non-returnable)
Product Key	ABRBEH
Catalog Page	Page 64 (C-2-2019)
GTIN	4046356708562
Weight per Piece (including packing)	35 g
Weight per Piece (excluding packing)	32.6 g
Customs tariff number	85366990
Country of origin	DE

Technical Data

Notes

Order information:	Order crimp contacts Ø 0.6 mm separately
--------------------	--

Safety note

Safety note	<p>WARNING: The connectors may not be plugged in or disconnected under load. Ignoring the warning or improper use may damage persons and/or property.</p>
	<ul style="list-style-type: none"> • WARNING: Commission properly functioning products only. The products must be regularly inspected for damage. Decommission defective products immediately. Replace damaged products. Repairs are not possible.
	<ul style="list-style-type: none"> • WARNING: Only electrically qualified personnel may install and operate the product. They must observe the following safety notes. The qualified personnel must be familiar with the basics of electrical engineering. They must be able to recognize and prevent danger. The relevant symbol on the packaging indicates that only personnel familiar with electrical engineering are allowed to install and operate the product.
	<ul style="list-style-type: none"> • The products are suitable for applications in plant, controller, and electrical device engineering.
	<ul style="list-style-type: none"> • When operating the connectors in outdoor applications, they must be separately protected against environmental influences.
	<ul style="list-style-type: none"> • Assembled products may not be manipulated or improperly opened.
	<ul style="list-style-type: none"> • Only use mating connectors that are specified in the technical data of the standards listed (e.g. the ones listed in the product accessories online at phoenixcontact.com/products).
	<ul style="list-style-type: none"> • When using the product in direct connection with third-party manufacturers, the user is responsible.
	<ul style="list-style-type: none"> • For operating voltages > 50 V AC, conductive connector housings must be grounded
	<ul style="list-style-type: none"> • Ensure that the protective or functional ground has been properly connected.
	<ul style="list-style-type: none"> • VDE 0100/1.97 § 411.1.3.2 and DIN EN 60 204/11.98 § 14.1.3 are applicable when combining several circuits in a cable and/or connector
	<ul style="list-style-type: none"> • Only use tools recommended by Phoenix Contact
	<ul style="list-style-type: none"> • The installation notes/Design In documents online on the download page at phoenixcontact.com/products must be observed for this product.
	<ul style="list-style-type: none"> • Operate the connector only when it is fully plugged in and interlocked.
<ul style="list-style-type: none"> • Ensure that when laying the cable, the tensile load on the connectors does not exceed the upper limit specified in the standards. 	
<ul style="list-style-type: none"> • Observe the minimum bending radius of the cable. Lay the cable without twisting it. 	
<ul style="list-style-type: none"> • The connector warms up in normal operation. Depending on the ambient conditions, the surface of the connector can continue to warm up. In this case, the user is responsible for posting 	

Cable connector - ST-17S1N8A8K02S



1613288

<https://www.phoenixcontact.com/pc/products/1613288>

warnings (e.g. DIN EN ISO 13732-1:2008-12).

Product properties

Product type	Circular connector (cable-side)
Number of positions	17
Connection profile	17
Application	Feedback, signal Signal
Locking type	SPEEDCON locking
Series	ST
Shielded	yes
Coding	N
Thread type	M17

Ambient conditions

Degree of protection	IP67
Ambient temperature (operation)	-40 °C ... 125 °C
Altitude	3000 m

Connector

Type	straight
Direction of rotation	Standard

Electrical properties

Contact

Contact diameter	0.6 mm
Max. current	3.6 A
Nominal voltage U_N	48 V AC 74 V DC
Overvoltage category	III
Rated surge voltage	1.5 kV

Material specifications

Seal material	FPM
Housing material	Metal

Connection data

Conductor connection

Connection method	Crimp connection
-------------------	------------------

Cable / line

Cable structure

External cable diameter	3.5 mm ... 5.5 mm
-------------------------	-------------------

Drawings

Diagram

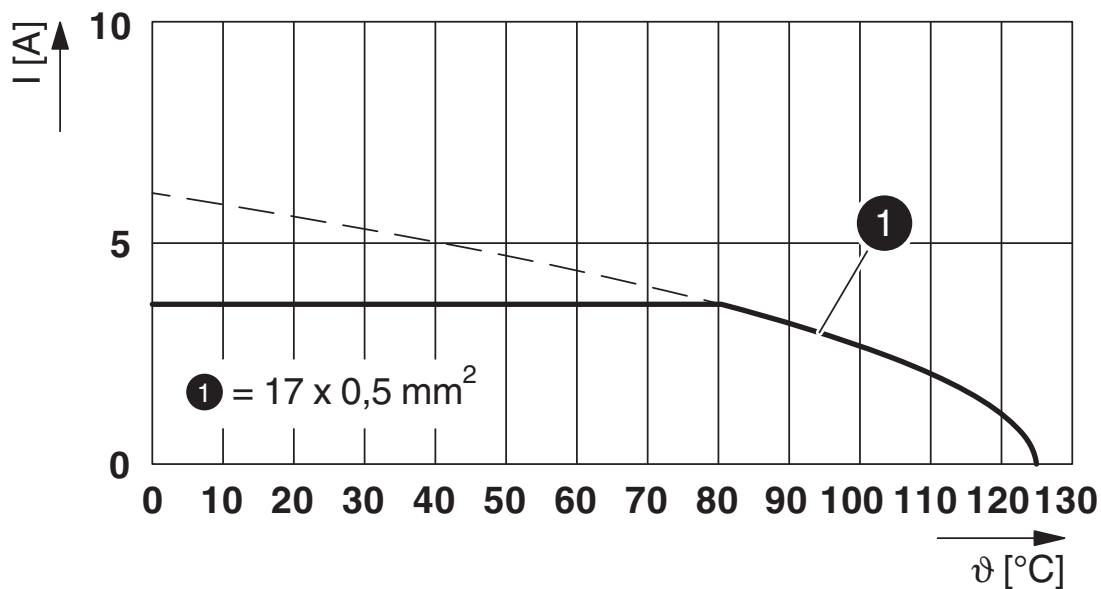

I = current strength, ϑ = ambient temperature, 17x 3.6 A

Schematic diagram

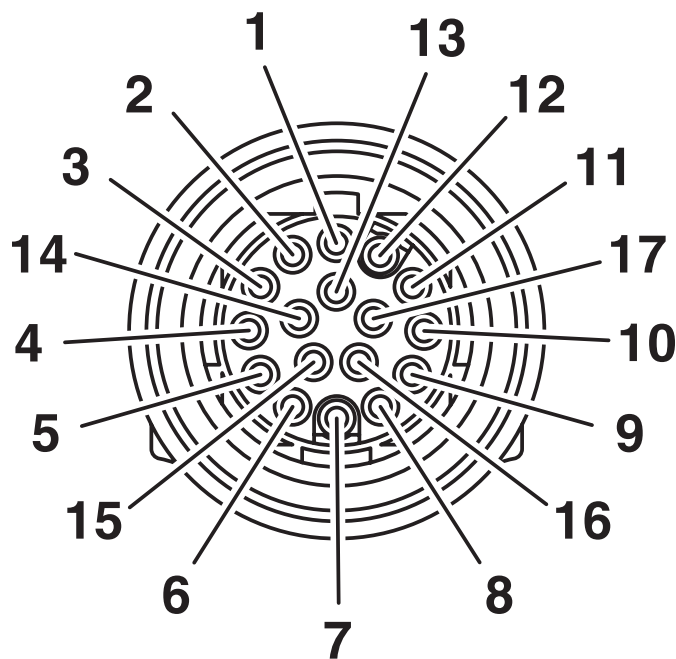

Connector pin assignment

Cable connector - ST-17S1N8A8K02S

1613288

<https://www.phoenixcontact.com/pc/products/1613288>



Dimensional drawing

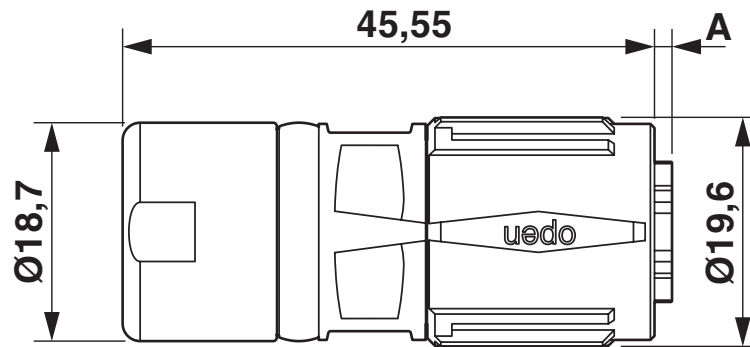

Cable connector - ST-17S1N8A8K02S



1613288

<https://www.phoenixcontact.com/pc/products/1613288>

Approvals

 cUL Recognized Approval ID: FILE E 335019				
	Nominal Voltage U_N	Nominal Current I_N	Cross Section AWG	Cross Section mm^2
	48 V	1 A	- 26	-

 UL Recognized Approval ID: FILE E 335019				
	Nominal Voltage U_N	Nominal Current I_N	Cross Section AWG	Cross Section mm^2
	48 V	1 A	- 26	-

 EAC Approval ID: B.01687				
--	--	--	--	--

 UL Recognized Approval ID: E153698-20140124				
	Nominal Voltage U_N	Nominal Current I_N	Cross Section AWG	Cross Section mm^2
	48 V	1 A	-	-

 cUL Recognized Approval ID: E153698-20140124				
	Nominal Voltage U_N	Nominal Current I_N	Cross Section AWG	Cross Section mm^2
	48 V	1 A	-	-

Cable connector - ST-17S1N8A8K02S



1613288

<https://www.phoenixcontact.com/pc/products/1613288>

Classifications

ECLASS

ECLASS-9.0	27440102
ECLASS-10.0.1	27440102
ECLASS-11.0	27440102

ETIM

ETIM 8.0	EC002635
----------	----------

UNSPSC

UNSPSC 21.0	39121400
-------------	----------

Cable connector - ST-17S1N8A8K02S



1613288

<https://www.phoenixcontact.com/pc/products/1613288>

Environmental Product Compliance

REACH SVHC	Lead 7439-92-1
China RoHS	Environmentally Friendly Use Period = 50 years
	For information on hazardous substances, refer to the manufacturer's declaration available under "Downloads"

Cable connector - ST-17S1N8A8K02S



1613288

<https://www.phoenixcontact.com/pc/products/1613288>

Accessories

Crimp contact

Crimp contact - ST-06KS010 - 1607580

<https://www.phoenixcontact.com/pc/products/1607580>



Crimp contact, turned, contact diameter: 0.6 mm, crimp range: 0.06 mm² ... 0.25 mm²

Crimp contact

Crimp contact - ST-06KS020 - 1607581

<https://www.phoenixcontact.com/pc/products/1607581>



Crimp contact, turned, contact diameter: 0.6 mm, crimp range: 0.14 mm² ... 0.34 mm²

Cable connector - ST-17S1N8A8K02S

1613288

<https://www.phoenixcontact.com/pc/products/1613288>

Crimp contact

Crimp contact - ST-06KS030 - 1607582

<https://www.phoenixcontact.com/pc/products/1607582>



Crimp contact, turned, contact diameter: 0.6 mm, crimp range: 0.34 mm² ... 0.5 mm²

Protective cap

Protective cap - ST-Z0024 - 1621904

<https://www.phoenixcontact.com/pc/products/1621904>



Plastic protection cap for connectors with M17 compact knurled nut and M17 compact SPEEDCON knurled nut

Cable connector - ST-17S1N8A8K02S

1613288

<https://www.phoenixcontact.com/pc/products/1613288>

Color-coding

Color-coding - ST-Z0016 - 1617993

<https://www.phoenixcontact.com/pc/products/1617993>

Color-coding, color: green



Color-coding

Color-coding - ST-Z0017 - 1618049

<https://www.phoenixcontact.com/pc/products/1618049>

Color-coding, color: orange



Cable connector - ST-17S1N8A8K02S



1613288

<https://www.phoenixcontact.com/pc/products/1613288>

Color-coding

Color-coding - ST-Z0018 - 1618050

<https://www.phoenixcontact.com/pc/products/1618050>

Color-coding, color: black



Phoenix Contact 2022 © - all rights reserved

<https://www.phoenixcontact.com>

PHOENIX CONTACT GmbH & Co. KG

Flachsmarktstraße 8

D-32825 Blomberg

+49 (0) 5235-3 00

info@phoenixcontact.com