

Sensor/actuator box - SACB-6/12-L- 5,0PUR SCO P



1452660

<https://www.phoenixcontact.com/pc/products/1452660>

Please be informed that the data shown in this PDF document is generated from our Online Catalog. Please find the complete data in the user documentation. Our General Terms of Use for Downloads are valid.



Sensor/actuator box, application: Standard, connection method: M12-SPEEDCON-socket Plastic, number of slots: 6, number of positions: 5, coding: A - standard, slot assignment: Double, status display: yes, pnp; master cable connection: Fixed connection 180°, PUR/PVC, cable length: 5 m, shielding: no

Your advantages

- Safety in the field, thanks to molded housing and high degree of protection
- Convenient: increased machine availability thanks to quick and easy diagnostics
- Save space: distributor box with double occupancy for two sensors in one slot
- Save time, thanks to installation with SPEEDCON fast locking system

Commercial Data

Item number	1452660
Packing unit	1 pc
Minimum order quantity	1 pc
Product Key	BF3CBA
Catalog Page	Page 262 (C-2-2019)
GTIN	4046356553964
Weight per Piece (including packing)	999.3 g
Weight per Piece (excluding packing)	999.3 g
Customs tariff number	85444290
Country of origin	DE

Sensor/actuator box - SACB-6/12-L- 5,0PUR SCO P



1452660

<https://www.phoenixcontact.com/pc/products/1452660>

Technical Data

Notes

Assembly instruction:	NOTE: Observe the permissible bending radii when laying conductors, since the degree of protection may be put in jeopardy if the bending forces are too high. Alleviate mechanical loads upstream of the connector, e.g. by using cable ties.
Note on application	Unused slots are to be sealed off prior to commissioning. Suitable sealing elements are to be found under "Accessories".

Product properties

Product type	Distributor boxes with M8 to M12 slots
Number of positions	5
Application	Standard
Number of slots	6
Coding	A - standard

Material specifications

Color	anthracite
Material of threaded sleeve	PBT
Contact material	Cu alloy
Contact surface material	gold-plated
Contact carrier material	PA
O-ring material	NBR
Material of the moulding mass	PUR
Housing material	PBT

Dimensions

Dimensional drawing	
Width	54 mm
Height	23 mm
Length	123 mm

Connection data

Pin assignment

Slot/position = Wire color or connection	1 / 4 (A) = WH
	1 / 2 (B) = GYPK

Sensor/actuator box - SACB-6/12-L- 5,0PUR SCO P



1452660

<https://www.phoenixcontact.com/pc/products/1452660>

	2 / 4 (A) = GN
	2 / 2 (B) = RDBU
	3 / 4 (A) = YE
	3 / 2 (B) = WHGN
	4 / 4 (A) = GY
	4 / 2 (B) = BNGN
	5 / 4 (A) = PK
	5 / 2 (B) = WHYE
	6 / 4 (A) = RD
	6 / 2 (B) = YEBN
	1-6 / 1 (+ 24 V) = BN
	1-6 / 3 (0 V) = BU
	1-6 / 5 (PE) = GNYE

LED signaling

Status display present	yes
------------------------	-----

Electrical properties

Max. operating voltage U_{max}	30 V DC
Local diagnostics	Supply voltage Green LED
	Status display I/O Yellow LED
Nominal voltage U_N	24 V DC
Rated current, total	12 A
Max. current carrying capacity per path	2 A
Current carrying capacity per slot	4 A

Cable / line

Cable length	5 m
--------------	-----

PUR/PVC black [PUR]

Dimensional drawing	
Cable weight	150.9 kg/km
UL AWM Style	20549
Number of positions	15
Shielded	no
Cable type	PUR/PVC black [PUR]
Conductor structure signal line	28x 0.15 mm
AWG signal line	20

Sensor/actuator box - SACB-6/12-L- 5,0PUR SCO P



1452660

<https://www.phoenixcontact.com/pc/products/1452660>

Conductor cross section	12x 0.5 mm ² (Signal line)
	3x 1 mm ² (power line)
Wire diameter incl. insulation	1.5 mm ±0.1 mm (Signal line)
	2.1 mm ±0.1 mm (power line)
External cable diameter	9.4 mm ±0.2 mm
Outer sheath, material	PUR
External sheath, color	black RAL 9005
Conductor material	Bare Cu litz wires
Material wire insulation	PVC
Single wire, color	brown, blue, green/yellow, white, green, yellow, gray, pink, red, gray/pink, red/blue, white/green, brown/green, white/yellow, yellow/brown
Thickness, insulation	≥ 0.15 mm (Inner sheath)
	≥ 0.76 mm (Outer cable sheath)
Overall twist	Wires twisted in layers
Nominal voltage, cable	300 V
Test voltage	2000 V
Minimum bending radius, fixed installation	7.5 x D
Minimum bending radius, flexible installation	10 x D
Max. bending cycles	1500000
Flame resistance	DIN EN 50265
Resistance to oil	according to VDE 0472 Part 803
Other resistance	Highly resistant to acids, alkaline solutions and solvents
Special properties	Silicone-free
Ambient temperature (operation)	-40 °C ... 90 °C (cable, fixed installation)
	-5 °C ... 80 °C (Cable, flexible installation)
	80 °C (in acc. with UL)

Standards and regulations

Standards/specifications	IEC 61076-2-101
--------------------------	-----------------

Ambient conditions

Degree of protection	IP65
	IP67
Ambient temperature (operation)	-25 °C ... 80 °C

Drawings

Circuit diagram

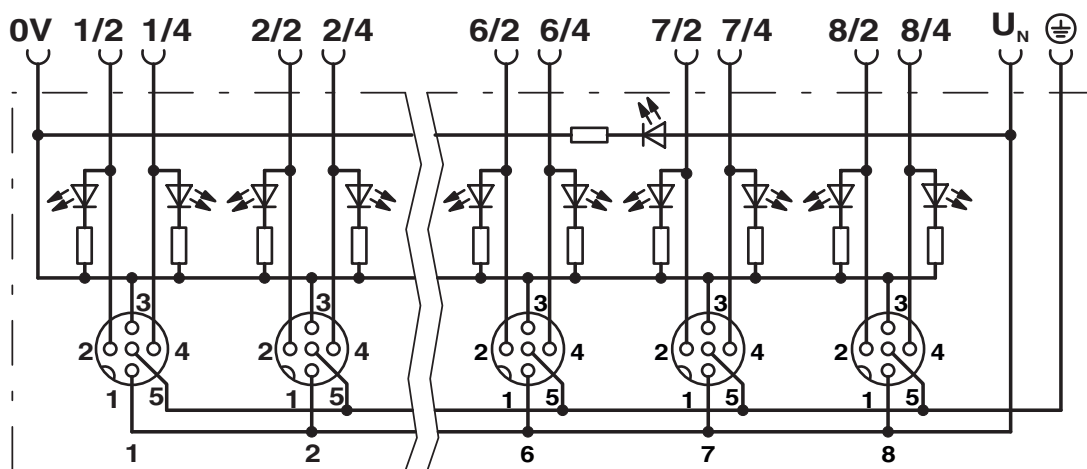

Sensor/actuator box - SACB-6/12-L- 5,0PUR SCO P

1452660

<https://www.phoenixcontact.com/pc/products/1452660>



Schematic diagram



M12 slot, socket, 5-pos.

Sensor/actuator box - SACB-6/12-L- 5,0PUR SCO P



1452660

<https://www.phoenixcontact.com/pc/products/1452660>

Dimensional drawing

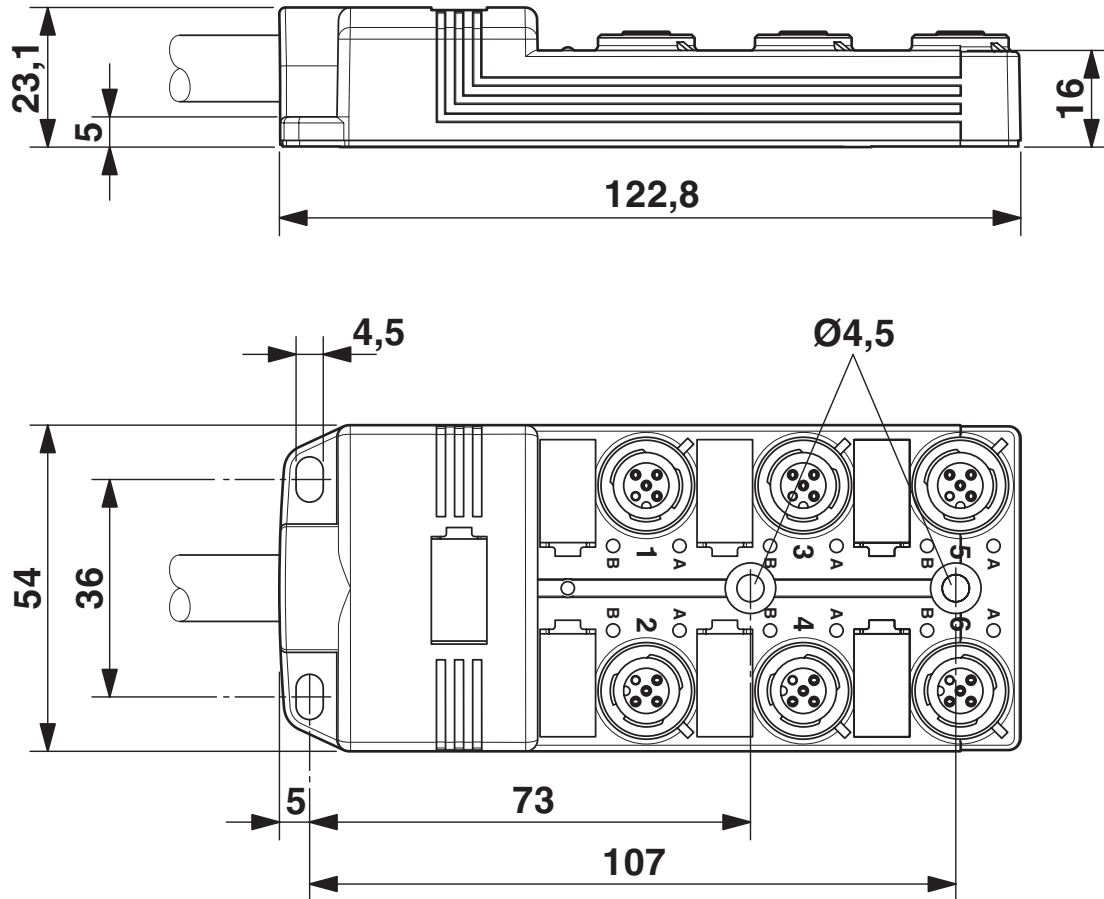

Sensor/actuator box - SACB-6/12-L- 5,0PUR SCO P





1452660

<https://www.phoenixcontact.com/pc/products/1452660>

Approvals

 cUL Recognized Approval ID: FILE E 118976				
	Nominal Voltage U_N	Nominal Current I_N	Cross Section AWG	Cross Section mm^2
	24 V		-	-

 UL Recognized Approval ID: FILE E 118976				
	Nominal Voltage U_N	Nominal Current I_N	Cross Section AWG	Cross Section mm^2
Signal		2 A	-	-
	24 V	4 A	-	-

 EAC Approval ID: RU C-DE.BL08.B.00286	
---	--

 EAC Approval ID: RU C-DE.BL08.B.00511	
---	--

cULus Recognized	
-------------------------	--

Sensor/actuator box - SACB-6/12-L- 5,0PUR SCO P



1452660

<https://www.phoenixcontact.com/pc/products/1452660>

Classifications

ECLASS

ECLASS-10.0.1	27440108
ECLASS-9.0	27440108
ECLASS-11.0	27440108

ETIM

ETIM 8.0	EC002585
----------	----------

UNSPSC

UNSPSC 21.0	31251500
-------------	----------

Sensor/actuator box - SACB-6/12-L- 5,0PUR SCO P



1452660

<https://www.phoenixcontact.com/pc/products/1452660>

Environmental Product Compliance

China RoHS	Environmentally friendly use period: unlimited = EFUP-e
	No hazardous substances above threshold values

1452660

<https://www.phoenixcontact.com/pc/products/1452660>

Accessories

Screw plug

Screw plug - PROT-MS SCO - 1553129

<https://www.phoenixcontact.com/pc/products/1553129>



M12 screw plug with fast-locking system for unoccupied M12 female connectors of sensor/actuator cables, boxes, and flush-type connectors

Torque screwdriver

Torque screwdriver - TSD 04 SAC - 1208429

<https://www.phoenixcontact.com/pc/products/1208429>



Torque screwdriver, with preset torque of 0.4 Nm and 4 mm hexagonal drive for M12 connectors

Sensor/actuator box - SACB-6/12-L- 5,0PUR SCO P



1452660

<https://www.phoenixcontact.com/pc/products/1452660>

Torque screwdriver

Torque screwdriver - TSD-M 1,2NM - 1212224

<https://www.phoenixcontact.com/pc/products/1212224>



Torque screw driver, accuracy as per EN ISO 6789 standard, adjustable from 0.3 - 1.2 Nm

Adapter insert

Adapter insert - TSD-M SAC-BIT ADAPTER - 1212600

<https://www.phoenixcontact.com/pc/products/1212600>



Adapter bit for TSD-M...torque tools, E6.3-1/4" drive with 4 mm hexagon to accommodate SAC bits

Sensor/actuator box - SACB-6/12-L- 5,0PUR SCO P

1452660

<https://www.phoenixcontact.com/pc/products/1452660>

Tool

Tool - SAC BIT M12-D15 - 1208432

<https://www.phoenixcontact.com/pc/products/1208432>



Nut for assembling sensor/actuator cables with M12 connector and M12 connectors for assembly, with a knurl diameter of 15 mm, for 4 mm hexagonal drive

Tool

Tool - SACC BIT M12-D20 - 1208445

<https://www.phoenixcontact.com/pc/products/1208445>



Nut for assembling M12 connectors for assembly with a knurl diameter of 20 mm, for 4 mm hexagonal drive

Sensor/actuator box - SACB-6/12-L- 5,0PUR SCO P



1452660

<https://www.phoenixcontact.com/pc/products/1452660>

Snap-in markers

Snap-in markers - UC-EM (17,5X9) - 0827490

<https://www.phoenixcontact.com/pc/products/0827490>



Snap-in markers, Sheet, white, unlabeled, can be labeled with: BLUEMARK ID, BLUEMARK ID COLOR, BLUEMARK CLED, BLUEMARK LED, CMS-P1-PLOTTER, PLOTMARK, mounting type: snapped, lettering field size: 17.5 x 9 mm, Number of individual labels: 20

Snap-in markers

Snap-in markers - UC-EM (17,5X9) CUS - 0828238

<https://www.phoenixcontact.com/pc/products/0828238>



Snap-in markers, can be ordered: by sheet, white, labeled according to customer specifications, mounting type: snapped into marker carrier, lettering field size: 17.5 x 9 mm, Number of individual labels: 20

Sensor/actuator box - SACB-6/12-L- 5,0PUR SCO P



1452660

<https://www.phoenixcontact.com/pc/products/1452660>

Snap-in markers

Snap-in markers - UCT-EM (17,5X9) - 0801491

<https://www.phoenixcontact.com/pc/products/0801491>



Snap-in markers, Sheet, white, unlabeled, can be labeled with: TOPMARK NEO, TOPMARK LASER, BLUEMARK ID COLOR, BLUEMARK ID, BLUEMARK CLED, THERMOMARK PRIME, THERMOMARK CARD 2.0, THERMOMARK CARD, mounting type: snapped, lettering field size: 17.5 x 9 mm, Number of individual labels: 24

Snap-in markers

Snap-in markers - UCT-EM (17,5X9) CUS - 0801575

<https://www.phoenixcontact.com/pc/products/0801575>



UniCard sheet, for labeling devices from other manufacturers, for overview table see download area, labeled according to customer specifications

1452660

<https://www.phoenixcontact.com/pc/products/1452660>

Snap-in markers

Snap-in markers - UC-EM (17,5X9) YE - 0827494

<https://www.phoenixcontact.com/pc/products/0827494>

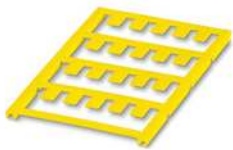

Snap-in markers, Sheet, yellow, unlabeled, can be labeled with: BLUEMARK ID COLOR, BLUEMARK ID, BLUEMARK CLED, PLOTMARK, CMS-P1-PLOTTER, mounting type: snapped, lettering field size: 17.5 x 9 mm, Number of individual labels: 20

Snap-in markers

Snap-in markers - UC-EM (17,5X9) YE CUS - 0828239

<https://www.phoenixcontact.com/pc/products/0828239>

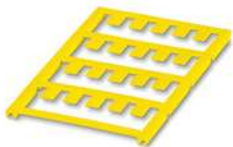

Snap-in markers, can be ordered: by sheet, yellow, labeled according to customer specifications, mounting type: snapped into marker carrier, lettering field size: 17.5 x 9 mm, Number of individual labels: 20

1452660

<https://www.phoenixcontact.com/pc/products/1452660>

Snap-in markers

Snap-in markers - UCT-EM (17,5X9) YE - 0801492

<https://www.phoenixcontact.com/pc/products/0801492>



Snap-in markers, Sheet, yellow, unlabeled, can be labeled with: TOPMARK NEO, TOPMARK LASER, BLUEMARK ID COLOR, BLUEMARK ID, BLUEMARK CLED, THERMOMARK PRIME, THERMOMARK CARD 2.0, THERMOMARK CARD, mounting type: snapped, lettering field size: 17.5 x 9 mm, Number of individual labels: 24

Snap-in markers

Snap-in markers - UCT-EM (17,5X9) YE CUS - 0801576

<https://www.phoenixcontact.com/pc/products/0801576>



UniCard sheet, for labeling devices from other manufacturers, for overview table see download area, labeled according to customer specifications

Sensor/actuator box - SACB-6/12-L- 5,0PUR SCO P



1452660

<https://www.phoenixcontact.com/pc/products/1452660>

DIN rail adapter

DIN rail adapter - UTA 107 - 2853983

<https://www.phoenixcontact.com/pc/products/2853983>

Universal DIN rail adapter, for screwing on switchgear



Phoenix Contact 2022 © - all rights reserved

<https://www.phoenixcontact.com>

PHOENIX CONTACT GmbH & Co. KG

Flachsmarktstraße 8

D-32825 Blomberg

+49 (0) 5235-3 00

info@phoenixcontact.com