

Sensor/actuator cable - SAC-3P-MS/ 0,6-PUR/C-1L-Z SCO



1435441

<https://www.phoenixcontact.com/pc/products/1435441>

Please be informed that the data shown in this PDF document is generated from our Online Catalog. Please find the complete data in the user documentation. Our General Terms of Use for Downloads are valid.



Sensor/actuator cable, 3-position, PUR halogen-free, black-gray RAL 7021, Plug straight M12 SPEEDCON, coding: A, on Valve connector C (8 mm), with 1 LED, connected with Z diode, cable length: 0.6 m

Your advantages

- Easy and safe: 100% electrically tested plug-in components
- Save time, thanks to installation with SPEEDCON fast locking system
- Convenient: increased machine availability thanks to quick and easy diagnostics
- Our standard: robust halogen-free PUR cable

Commercial Data

Item number	1435441
Packing unit	1 pc
Minimum order quantity	1 pc
Product Key	BF1DNA
Catalog Page	Page 228 (C-2-2019)
GTIN	4046356413732
Weight per Piece (including packing)	41.6 g
Weight per Piece (excluding packing)	40 g
Customs tariff number	85444290
Country of origin	PL

Sensor/actuator cable - SAC-3P-MS/ 0,6-PUR/C-1L-Z SCO



1435441

<https://www.phoenixcontact.com/pc/products/1435441>

Technical Data

Product properties

Product type	Sensor/actuator cable with valve connector
Number of positions	3
Application	Standard
No. of cable outlets	1
Shielded	no
Coding	A - standard

Insulation characteristics

Overvoltage category	III
Degree of pollution	3

Material specifications

Flammability rating according to UL 94	HB
Sealing material	TPU (Seal molded)
Material housing valve plug	TPU
Material of grip body	TPU
Contact material	CuSn
Contact surface material	Ni/Au
Contact carrier material	TPU GF
Contact material	CuSn
Valve plug contact insert material	PA 6.6
Contact surface material	Sn
Material for screw connection	Zinc die-cast, nickel-plated

Electrical properties

Contact resistance	$\leq 5 \text{ m}\Omega$
Insulation resistance	$\geq 100 \text{ M}\Omega$
Nominal voltage U_N	24 V AC
	24 V DC
Nominal current I_N	4 A
Protective circuit	Z diode

Valve connector characteristics

Fixing screws	M2,5 x 27,5
Pulse power	40 W (at 100 μs square-wave pulse)
Terminal voltage	70 V (at 2 mA constant current)
Reverse voltage	50 V

Mechanical properties

Mechanical data

Insertion/withdrawal cycles	≥ 100 (M12 connector)
-----------------------------	----------------------------

Sensor/actuator cable - SAC-3P-MS/ 0,6-PUR/C-1L-Z SCO



1435441

<https://www.phoenixcontact.com/pc/products/1435441>

LED signaling

Status display	1 LED
Status display present	yes

Connector

Connection 1

Head design	Plug
Head cable outlet	straight
Head thread type	M12
Head locking type	SPEEDCON
Coding	A

Connection 2

Head design	Valve connector
Head thread type	C (8 mm)
Status indicator head	1 LED

Cable / line

Cable length	0.6 m
--------------	-------

PUR halogen-free black [PUR]

Dimensional drawing	
Cable weight	30 kg/km
UL AWM Style	20549
Number of positions	3
Shielded	no
Cable type	PUR halogen-free black [PUR]
Conductor structure signal line	28x 0.15 mm
AWG signal line	20
Conductor cross section	3x 0.5 mm ²
Wire diameter incl. insulation	1.5 mm ±0.05 mm (Signal line)
External cable diameter	4.5 mm ±0.2 mm
Outer sheath, material	PUR
External sheath, color	black-gray RAL 7021
Conductor material	Bare Cu litz wires
Material wire insulation	PP
Single wire, color	black 1, black 2, green/yellow

Sensor/actuator cable - SAC-3P-MS/ 0,6-PUR/C-1L-Z SCO



1435441

<https://www.phoenixcontact.com/pc/products/1435441>

Overall twist	3 wires, twisted
Max. conductor resistance	39 Ω/km (at 20 °C)
Insulation resistance	min. 20 MΩ*km
Nominal voltage, cable	≤ 300 V
Test voltage	≥ 1200 V
Minimum bending radius, fixed installation	5 x D
Minimum bending radius, flexible installation	10 x D
Smallest bending radius, fixed installation	22.5 mm
Max. bending cycles	15000000
Halogen-free	in accordance with DIN VDE 0472 part 815
Flame resistance	according to DIN VDE 0482 According to DIN EN 50265-2-1
Resistance to oil	in accordance with DIN EN 60811-2-1
Other resistance	largely oil-resistant partly UV-resistant in accordance with DIN EN ISO 4892-2-A
Ambient temperature (operation)	-40 °C ... 80 °C (cable, fixed installation) -20 °C ... 80 °C (Cable, flexible installation)

Ambient conditions

Degree of protection	IP65 IP67
Ambient temperature (operation)	-25 °C ... 90 °C (Plug / socket) -20 °C ... 85 °C (valve plug) -40 °C ... 80 °C (cable, fixed installation) -15 °C ... 80 °C (Cable, flexible installation)

Standards and regulations

M12

Standards/specifications	IEC 61076-2-101
--------------------------	-----------------

Valve connector

Standards/specifications	EN 175301-803
--------------------------	---------------

Sensor/actuator cable - SAC-3P-MS/ 0,6-PUR/C-1L-Z SCO

1435441

<https://www.phoenixcontact.com/pc/products/1435441>

Drawings

Dimensional drawing

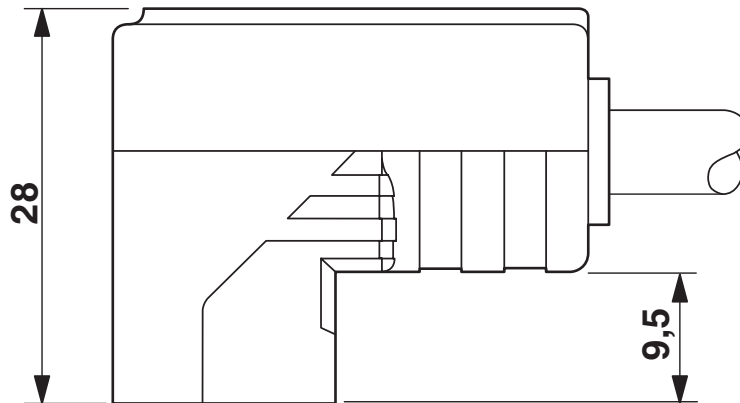

Valve connector, type C, side view

Schematic diagram

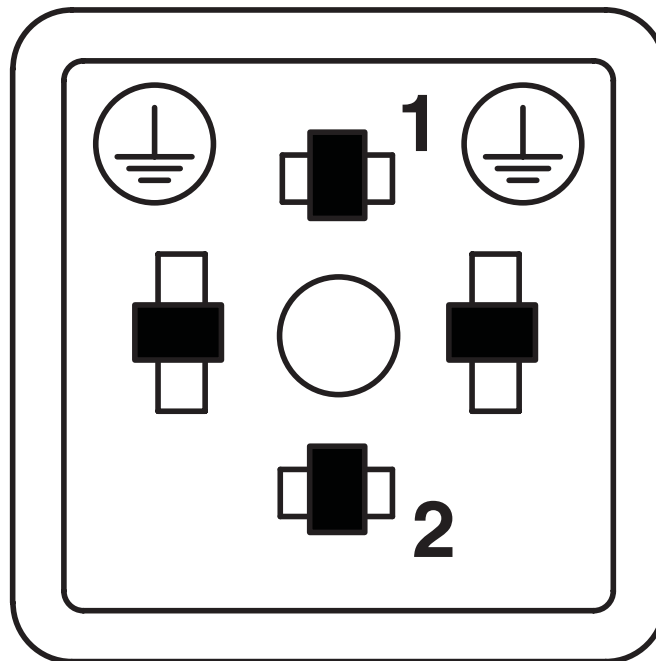

Valve connector connector pin assignment, type C

Sensor/actuator cable - SAC-3P-MS/ 0,6-PUR/C-1L-Z SCO

1435441

<https://www.phoenixcontact.com/pc/products/1435441>

Dimensional drawing

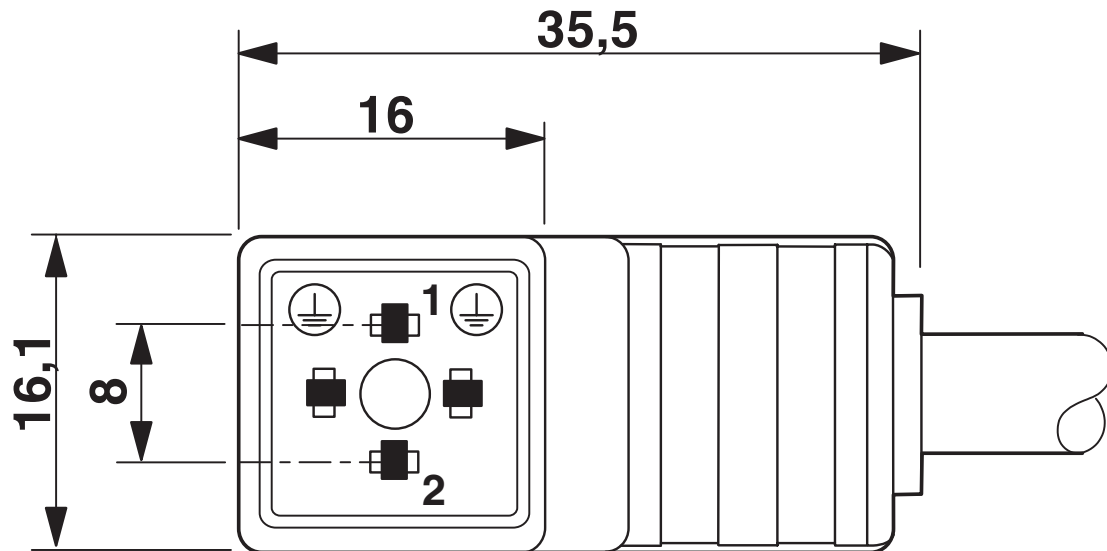

Valve connector, type C

Dimensional drawing

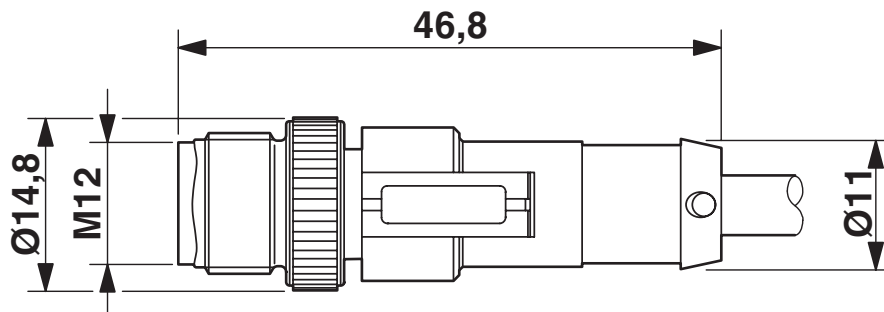

Plug, M12 x 1, straight, shielded

Sensor/actuator cable - SAC-3P-MS/ 0,6-PUR/C-1L-Z SCO



1435441

<https://www.phoenixcontact.com/pc/products/1435441>

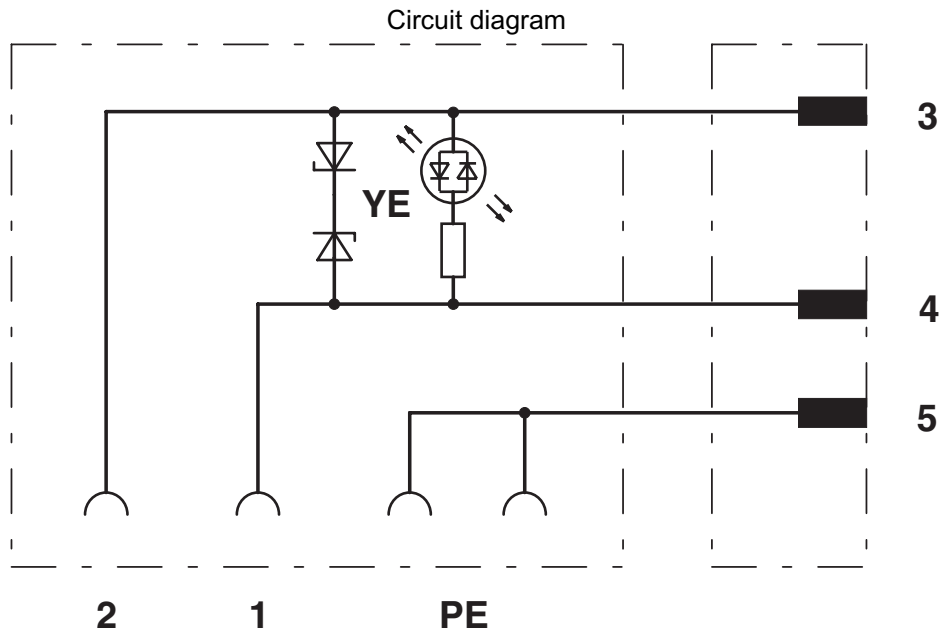

Schematic diagram

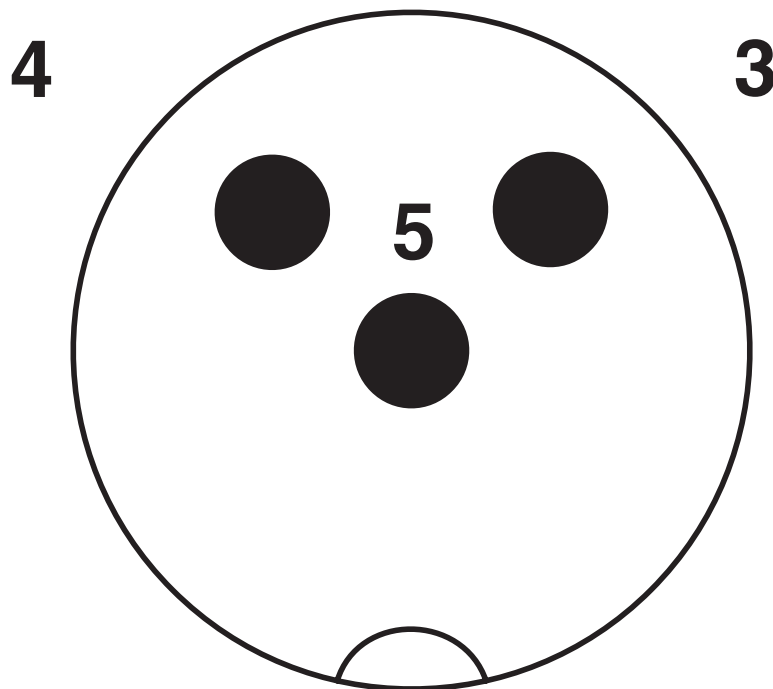

Pin assignment M12 plug, 3-pos., valve connector

Sensor/actuator cable - SAC-3P-MS/ 0,6-PUR/C-1L-Z SCO



1435441

<https://www.phoenixcontact.com/pc/products/1435441>

Approvals



EAC

Approval ID: RU C-DE.BL08.B.00286



EAC

Approval ID: RU D-DE.HB35.B.00387



CSAus

Approval ID: 13631

	Nominal Voltage U_N	Nominal Current I_N	Cross Section AWG	Cross Section mm^2
	24 V	4 A	-	-

Sensor/actuator cable - SAC-3P-MS/ 0,6-PUR/C-1L-Z SCO



1435441

<https://www.phoenixcontact.com/pc/products/1435441>

Classifications

ECLASS

ECLASS-9.0	27060312
ECLASS-10.0.1	27060312
ECLASS-11.0	27060312

ETIM

ETIM 8.0	EC001855
----------	----------

UNSPSC

UNSPSC 21.0	31251500
-------------	----------

Sensor/actuator cable - SAC-3P-MS/ 0,6-PUR/C-1L-Z SCO



1435441

<https://www.phoenixcontact.com/pc/products/1435441>

Environmental Product Compliance

China RoHS	Environmentally Friendly Use Period = 50 years
	For information on hazardous substances, refer to the manufacturer's declaration available under "Downloads"

Sensor/actuator cable - SAC-3P-MS/ 0,6-PUR/C-1L-Z SCO



1435441

<https://www.phoenixcontact.com/pc/products/1435441>

Accessories

Screw insert

Screw insert - SF-BIT-PH 2-70 - 1212583

<https://www.phoenixcontact.com/pc/products/1212583>



Screw bit, PH crosshead, E6.3-1/4" drive, size: PH 2 x 70 mm, suitable for holder according to DIN 3126-F6.3/ISO 1173

Sealing cap

Sealing cap - PROT-M12 FS-PA-CHAIN - 1430873

<https://www.phoenixcontact.com/pc/products/1430873>



M12 sealing cap made of plastic with fixing band, for sensor cables, for free M12 plugs

Sensor/actuator cable - SAC-3P-MS/ 0,6-PUR/C-1L-Z SCO



1435441

<https://www.phoenixcontact.com/pc/products/1435441>

Locking clip

Locking clip - SAC-M12-EXCLIP-M - 1558988

<https://www.phoenixcontact.com/pc/products/1558988>



Locking clip for the pin side of sensor/actuator cables with M12 connector and M12 connectors for assembly, for knurl diameter: 15 mm or for Allen key with a wrench size of 14 mm, prevents the disconnection of plug-in connections without tools

Insert label

Insert label - PABA WH/23 - 1013779

<https://www.phoenixcontact.com/pc/products/1013779>



Insert label, Strip, white, unlabeled, can be labeled with: CMS-P1-PLOTTER, mounting type: slide-on, cable diameter range: 1.5 ... 35 mm, lettering field size: 23 x 4 mm, Number of individual labels: 20

Sensor/actuator cable - SAC-3P-MS/ 0,6-PUR/C-1L-Z SCO



1435441

<https://www.phoenixcontact.com/pc/products/1435441>

Insert label

Insert label - PABA YE/23 - 1013782

<https://www.phoenixcontact.com/pc/products/1013782>



Insert label, Strip, yellow, unlabeled, can be labeled with: CMS-P1-PLOTTER, mounting type: slide-on, cable diameter range: 1.5 ... 35 mm, lettering field size: 23 x 4 mm, Number of individual labels: 20

Marker pen

Marker pen - B-STIFT - 1051993

<https://www.phoenixcontact.com/pc/products/1051993>



Marker pen, for manual labeling of unprinted Zack strips, smear-proof and waterproof, line thickness 0.5 mm

Sensor/actuator cable - SAC-3P-MS/ 0,6-PUR/C-1L-Z SCO



1435441

<https://www.phoenixcontact.com/pc/products/1435441>

Torque screwdriver

Torque screwdriver - TSD 04 SAC - 1208429

<https://www.phoenixcontact.com/pc/products/1208429>



Torque screwdriver, with preset torque of 0.4 Nm and 4 mm hexagonal drive for M12 connectors

Torque screwdriver

Torque screwdriver - TSD-M 1,2NM - 1212224

<https://www.phoenixcontact.com/pc/products/1212224>



Torque screw driver, accuracy as per EN ISO 6789 standard, adjustable from 0.3 - 1.2 Nm

Sensor/actuator cable - SAC-3P-MS/ 0,6-PUR/C-1L-Z SCO



1435441

<https://www.phoenixcontact.com/pc/products/1435441>

Adapter insert

Adapter insert - TSD-M SAC-BIT ADAPTER - 1212600

<https://www.phoenixcontact.com/pc/products/1212600>



Adapter bit for TSD-M...torque tools, E6.3-1/4" drive with 4 mm hexagon to accommodate SAC bits

Tool

Tool - SAC BIT M12-D15 - 1208432

<https://www.phoenixcontact.com/pc/products/1208432>



Nut for assembling sensor/actuator cables with M12 connector and M12 connectors for assembly, with a knurl diameter of 15 mm, for 4 mm hexagonal drive

Phoenix Contact 2023 © - all rights reserved
<https://www.phoenixcontact.com>

PHOENIX CONTACT GmbH & Co. KG
Flachsmarktstraße 8
D-32825 Blomberg
+49 (0) 5235-3 00
info@phoenixcontact.com