

Housing - HC-STA-B48-HHFS-1TTM50-EM-AL - 1424856

Please be informed that the data shown in this PDF Document is generated from our Online Catalog. Please find the complete data in the user's documentation. Our General Terms of Use for Downloads are valid (<http://phoenixcontact.com/download>)



Sleeve housing B48, for single locking latch, material: Die-cast aluminum, salt water resistant, cable outlets: 1, straight, height: 107.5 mm, cable gland: none, support sleeve: no, 1x M50, Standard

Your advantages

- good shielding in the event of electromagnetic interference



Key Commercial Data

Packing unit	1 pc
GTIN	 4 055626 382616
GTIN	4055626382616
Weight per Piece (excluding packing)	580.000 g
Custom tariff number	85389099
Country of origin	China

Technical data

Dimensions

Height	107.5 mm
Width	90 mm
Length	132 mm

Ambient conditions

Degree of protection (IP)	IP66
	IP67
Ambient temperature (operation)	-40 °C ... 125 °C

Housing - HC-STA-B48-HHFS-1TTM50-EM-AL - 1424856

Technical data

General

Size	B48
Housing type	Sleeve housing
Color	gray aluminum
Locking type	for single locking latch
No. of cable outlets	1
Cable outlet	straight
Screw connection	none
Type of the screw connection	1x M50
Housing material	Die-cast aluminum, salt water resistant
Housing surface material	uncoated

Environmental Product Compliance

China RoHS	Environmentally Friendly Use Period = 50
	For details about hazardous substances go to tab "Downloads", Category "Manufacturer's declaration"

Drawings

Dimensional drawing

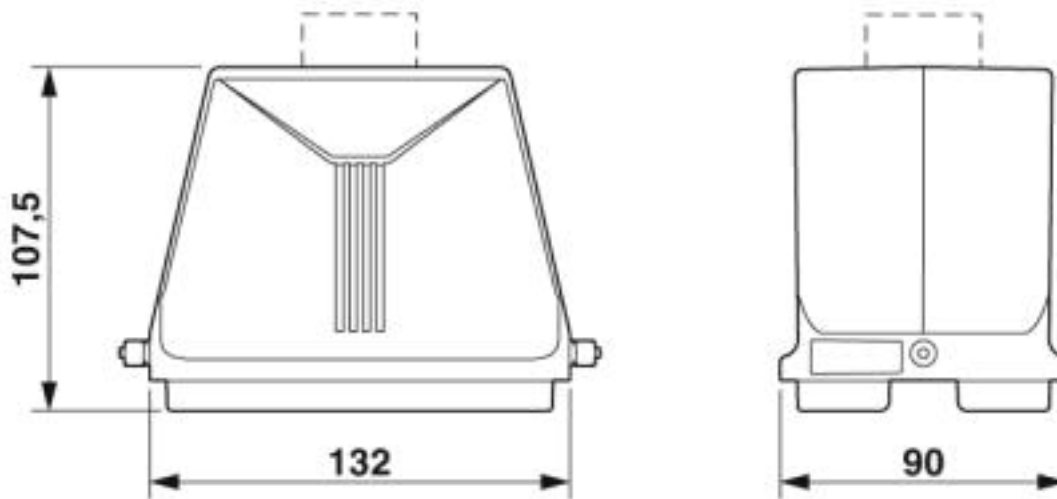

Dimensional drawing

Classifications

eCl@ss

eCl@ss 5.1	27261200
------------	----------

Housing - HC-STA-B48-HHFS-1TTM50-EM-AL - 1424856

Classifications

eCl@ss

eCl@ss 6.0	27261200
eCl@ss 7.0	27440202
eCl@ss 8.0	27440202
eCl@ss 9.0	27440202

ETIM

ETIM 6.0	EC000437
ETIM 7.0	EC000437

Approvals

Approvals

Approvals

DNV GL

Ex Approvals

Approval details

DNV GL		https://approvalfinder.dnvgl.com/	TAE000037S
--------	---	---	------------
