

Sensor/actuator cable - SAC-8P- 15,0-542/ FR SCO BK - 1418055

Please be informed that the data shown in this PDF Document is generated from our Online Catalog. Please find the complete data in the user's documentation. Our General Terms of Use for Downloads are valid (<http://phoenixcontact.com/download>)



Sensor/actuator cable, 8-position, PVC, yellow, free cable end, on Socket angled M12 SPEEDCON, A-coded, cable length: 15 m



Key Commercial Data

Packing unit	1 pc
GTIN	 4 055626 211657
GTIN	4055626211657
Weight per Piece (excluding packing)	1.000 g
Custom tariff number	85444290
Country of origin	United States

Technical data

Dimensions

Length of cable	15 m
-----------------	------

Ambient conditions

Ambient temperature (operation)	-25 °C ... 90 °C (Plug / socket)
Degree of protection	IP65
	IP67
	IP68

General

Rated current at 40°C	2 A
Rated voltage	30 V AC
	30 V DC

Sensor/actuator cable - SAC-8P- 15,0-542/ FR SCO BK - 1418055

Technical data

General

Number of positions	8
Color handle area	black
Insulation resistance	≥ 100 MΩ
Coding	A - standard
Standards/regulations	M12 connector IEC 61076-2-101
Status display	No
Protective circuit/component	unwired
Overvoltage category	II
Degree of pollution	3
Insertion/withdrawal cycles	≥ 100
Torque	0.4 Nm (M12 connector)

Material

Flammability rating according to UL 94	HB
Contact material	CuZn
Contact surface material	Ni/Au
Contact carrier material	TPU GF
Material of grip body	TPU, hardly inflammable, self-extinguishing
Material, knurls	Zinc die-cast, nickel-plated
Sealing material	NBR

Standards and Regulations

Standard designation	M12 connector
Standards/regulations	IEC 61076-2-101
Flammability rating according to UL 94	HB

Cable

Cable type	PVC yellow 105 °C
Cable type (abbreviation)	542
UL AWM style	2517 (105 °C / 300 V)
AWG signal line	24
Conductor structure signal line	32x 1.10 mm
Core diameter including insulation	1.12 mm ±0.03 mm
Wire colors	white, brown, green, yellow, gray, pink, blue, red
Overall twist	8 wires around filler to the core
External sheath, color	yellow
External cable diameter D	5.7 mm ±0.2 mm
Minimum bending radius, flexible installation	8 x D
Cable weight	44 kg/km

Sensor/actuator cable - SAC-8P- 15,0-542/ FR SCO BK - 1418055

Technical data

Cable

Outer sheath, material	PVC
Material, filler	PP
Material conductor insulation	PVC
Conductor material	Tin-plated Cu litz wires
Insulation resistance	≥ (550 M Ohms/m @ 500V)
Conductor resistance	max. 79.7 Ω/km (20 °C)
Nominal voltage, cable	300 V
Flame resistance	FT4
Other resistance	UV resistant
Ambient temperature (operation)	-30 °C ... 105 °C (cable, fixed installation)
	-5 °C ... 105 °C (cable, flexible installation)

Environmental Product Compliance

	Lead 7439-92-1
China RoHS	Environmentally Friendly Use Period = 50
	For details about hazardous substances go to tab "Downloads", Category "Manufacturer's declaration"

Drawings

Sensor/actuator cable - SAC-8P- 15,0-542/ FR SCO BK - 1418055

Schematic diagram

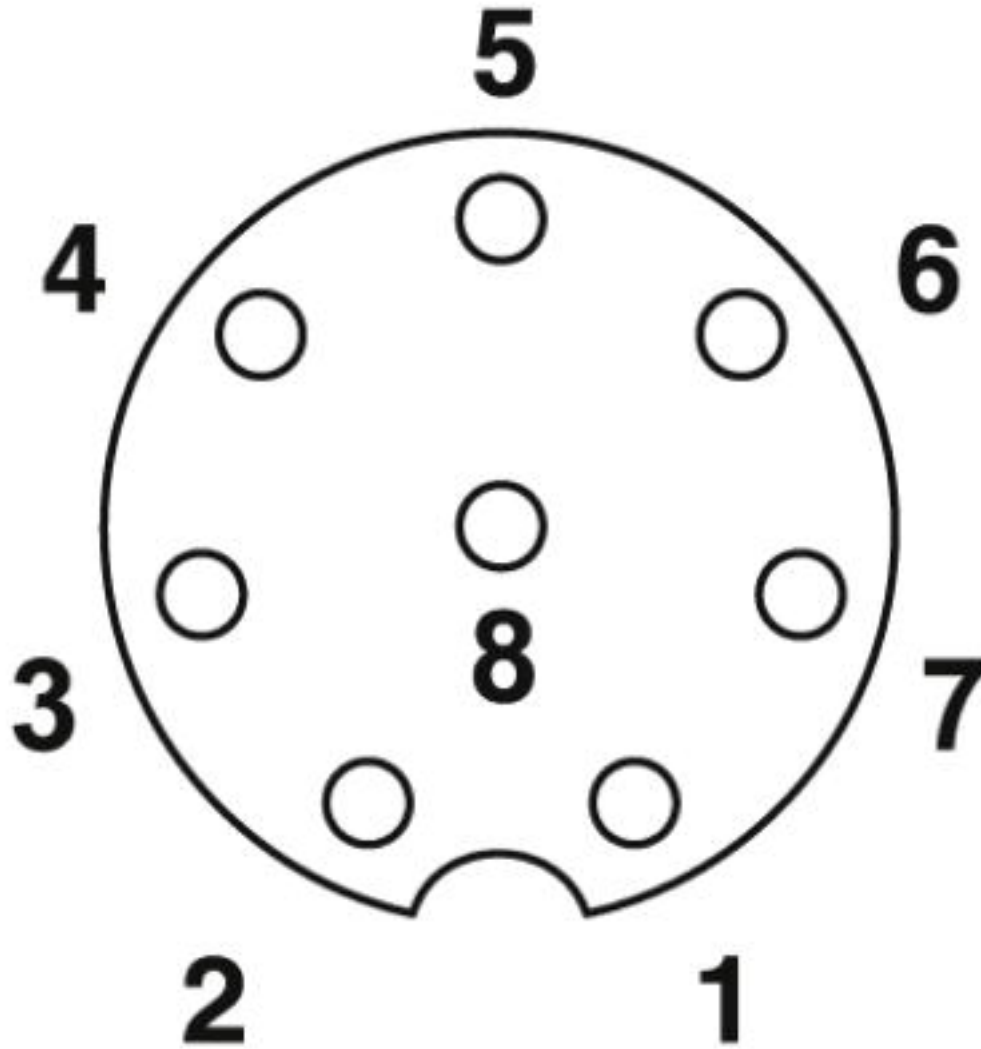

Pin assignment M12 socket, 8-pos., A-coded, view female side

Sensor/actuator cable - SAC-8P- 15,0-542/ FR SCO BK - 1418055

Schematic diagram

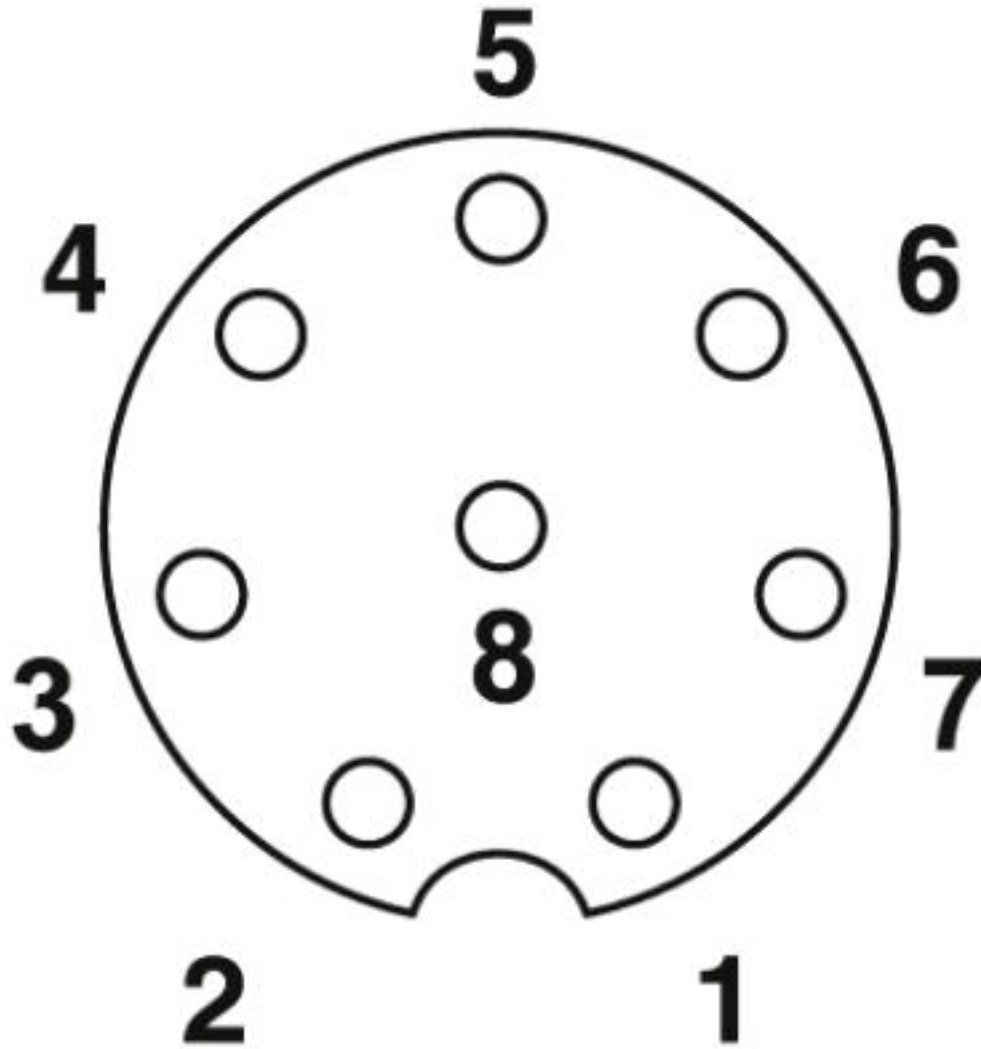

Pin assignment M12 socket, 8-pos., A-coded, view female side

Sensor/actuator cable - SAC-8P- 15,0-542/ FR SCO BK - 1418055

Dimensional drawing

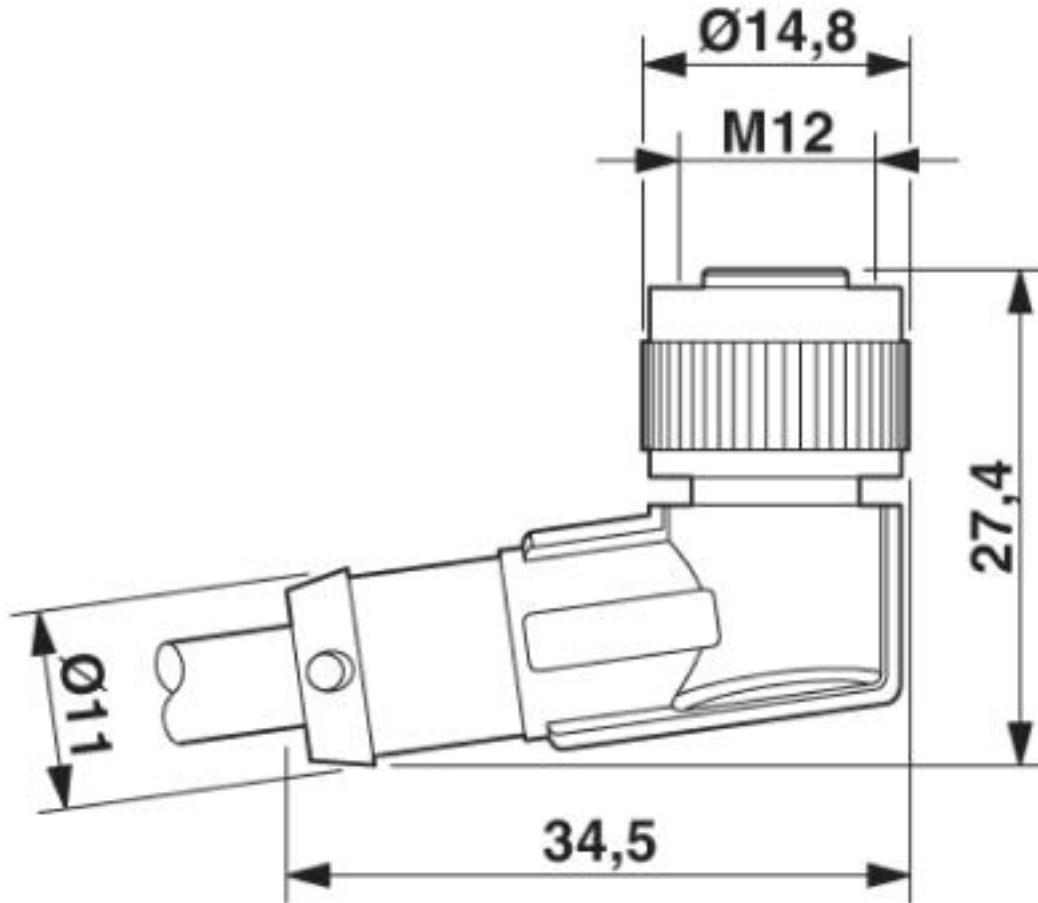

M12 x 1 socket, angled

Sensor/actuator cable - SAC-8P- 15,0-542/ FR SCO BK - 1418055

Circuit diagram

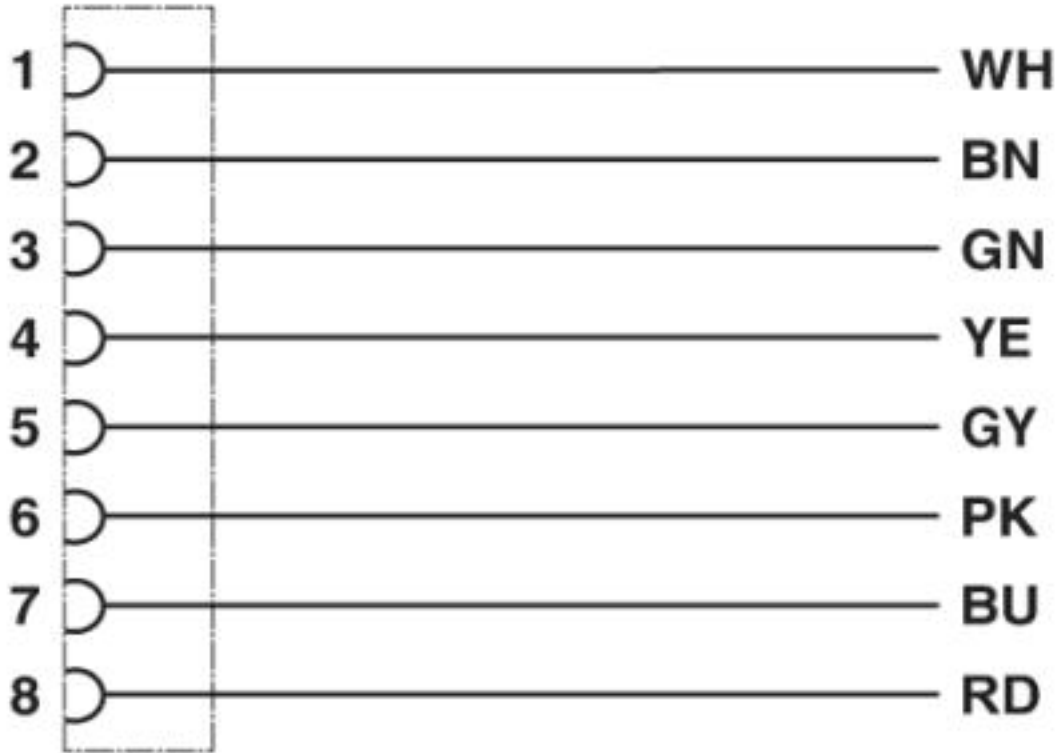

Contact assignment of the M12 socket

Sensor/actuator cable - SAC-8P- 15,0-542/ FR SCO BK - 1418055

Cable cross section

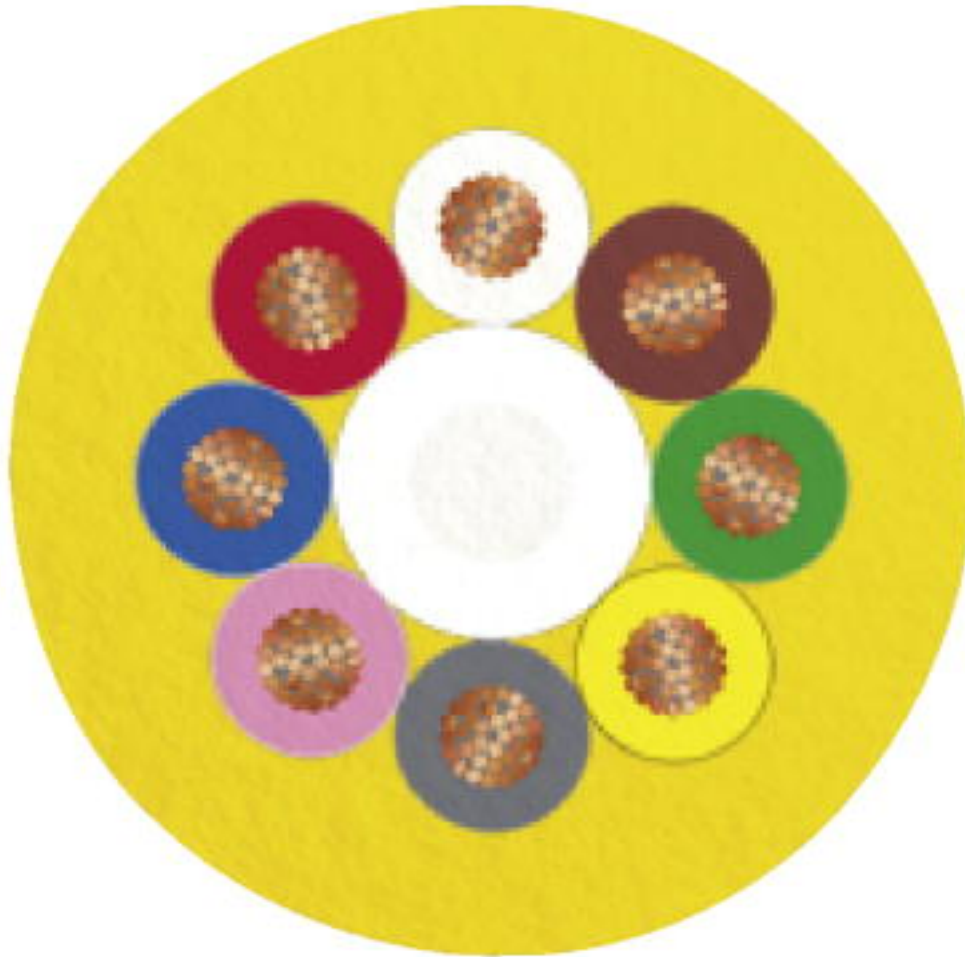

PVC yellow 105 °C [542]

Classifications

eCl@ss

eCl@ss 5.1	27061801
eCl@ss 6.0	27279200
eCl@ss 7.0	27279218
eCl@ss 8.0	27279218
eCl@ss 9.0	27060311

Sensor/actuator cable - SAC-8P- 15,0-542/ FR SCO BK - 1418055

Classifications

ETIM

ETIM 5.0	EC001855
ETIM 6.0	EC001855
ETIM 7.0	EC001855

UNSPSC

UNSPSC 13.2	31251501
-------------	----------

Approvals

Approvals

Approvals

UL Listed / cUL Listed / EAC / cULus Listed

Ex Approvals

Approval details

UL Listed		http://database.ul.com/cgi-bin/XYV/template/LISEXT/1FRAME/index.htm	FILE E 221474
Nominal voltage UN		30 V	
Nominal current IN		2 A	

cUL Listed		http://database.ul.com/cgi-bin/XYV/template/LISEXT/1FRAME/index.htm	FILE E 221474
Nominal voltage UN		30 V	
Nominal current IN		2 A	

EAC		RU C- DE.BL08.B.00286
-----	---	--------------------------

Sensor/actuator cable - SAC-8P- 15,0-542/ FR SCO BK - 1418055

Approvals

cULus Listed



Accessories

Accessories

Conductor marking

Insert label - PABA WH/23 - 1013779



Insert label, Strip, white, unlabeled, can be labeled with: CMS-P1-PLOTTER, mounting type: thread on, cable diameter range: 1.5 ... 35 mm, lettering field size: 23 x 4 mm, Number of individual labels: 20

Insert label - PABA YE/23 - 1013782



Insert label, Strip, yellow, unlabeled, can be labeled with: CMS-P1-PLOTTER, mounting type: thread on, cable diameter range: 1.5 ... 35 mm, lettering field size: 23 x 4 mm, Number of individual labels: 20

Corrugated pipe

Protective hose - WP-PA HF 13,0 BK - 3240681



Polyamide protective hose, inflammability class V0, UV resistant

Protective hose - WP-PA HF-HB 13,0 BK - 3240839



Polyamide protective hose, inflammability class HB, UV resistant

Sensor/actuator cable - SAC-8P- 15,0-542/ FR SCO BK - 1418055

Accessories

Cutting tools

Diagonal cutter - CUTFOX-S VDE - 1212207



Diagonal cutter for hard (piano wire) and soft wires, VDE 1000 V AC/1500 V DC tested

Marker pen

Marker pen - B-STIFT - 1051993



Marker pen, for manual labeling of unprinted Zack strips, smear-proof and waterproof, line thickness 0.5 mm

Protective cap

Screw plug - PROT-M12 MS-PA-CHAIN - 1430899



M12 sealing cap with fixing band, for sensor cables, for free M12 sockets

Safety locking

Locking clip - SAC-M12-EXCLIP-F - 1558991



Locking clip for the socket side of sensor/actuator cables with M12 connector and M12 connectors for assembly, for knurl diameter: 15 mm or for Allen key with a wrench size of 14 mm, prevents the disconnection of plug-in connections without tools

Screwdriver tools

Sensor/actuator cable - SAC-8P- 15,0-542/ FR SCO BK - 1418055

Accessories

Adapter insert - TSD-M SAC-BIT ADAPTER - 1212600



Adapter bit for TSD-M...torque tools, E6.3-1/4" drive with 4 mm hexagon to accommodate SAC bits

Tool - SAC BIT M12-D15 - 1208432



Nut for assembling sensor/actuator cables with M12 connector and M12 connectors for assembly, with a knurl diameter of 15 mm, for 4 mm hexagonal drive

Stripping tool

Stripping tool - WIREFOX SAC-1 - 1212757



Stripping pliers, for halogen-free sensor/actuator cables (SAC cables), with PUR and PVC insulation, from Ø of 3.2 to 4.4 mm, any stripping length

Stripping tool - WIREFOX SAC - 1212623



Stripping pliers, for halogen-free sensor/actuator cables (SAC cables), with PUR and PVC insulation, from Ø of 4.4 to 7 mm, any stripping length

Stripping tool - WIREFOX 10 - 1212150



Stripping tool, for cables and conductors from 0.02 - 10 mm², self-adjusting, stripping length of up to 18 mm, cutting capacity of up to 10 mm² stranded/1.5 mm² solid, replaceable stripping blade

Sensor/actuator cable - SAC-8P- 15,0-542/ FR SCO BK - 1418055

Accessories

Torque tool

Torque screwdriver - TSD 04 SAC - 1208429



Torque screwdriver, with preset torque of 0.4 Nm and 4 mm hexagonal drive for M12 connectors

Torque screwdriver - TSD-M 1,2NM - 1212224



Torque screw driver, accuracy as per EN ISO 6789 standard, adjustable from 0.3 - 1.2 Nm

Protective hose adapter - WP-CTA POM 13,0 BK - 1422884



Protective hose adapter, for corrugated hoses with a nominal size of 13 (10 x 13), corrugated in parallel
