

## EMV nut - A-INLE-PG9-N-S - 1411276

Please be informed that the data shown in this PDF Document is generated from our Online Catalog. Please find the complete data in the user's documentation. Our General Terms of Use for Downloads are valid (<http://phoenixcontact.com/download>)

EMV nut, material: Brass, nickel-plated, for threads Pg9, color: silver



### Key Commercial Data

Packing unit	1 pc
GTIN	 4 046356 924184
GTIN	4046356924184
Weight per Piece (excluding packing)	3.600 g
Custom tariff number	74153300
Country of origin	Germany

### Technical data

#### Dimensions

Length	4.7 mm
Connecting thread diameter	15.2 mm
Wrench size, counter nut	18 mm
Hexagon angular dimension	20 mm

#### Ambient conditions

Ambient temperature (operation)	-70 °C ... 220 °C
---------------------------------	-------------------

#### General

Material	Brass, nickel-plated
Thread type on connection side	Pg9
Color	silver

# EMV nut - A-INLE-PG9-N-S - 1411276

## Technical data

### General

Assembly instructions	for EMC cable glands, for removing a non-conductive surface coating
-----------------------	---

### Standards and Regulations

Halogen-free	yes
--------------	-----

### Environmental Product Compliance

	Lead 7439-92-1
China RoHS	Environmentally Friendly Use Period = 50
	For details about hazardous substances go to tab "Downloads", Category "Manufacturer's declaration"

## Drawings

Dimensional drawing

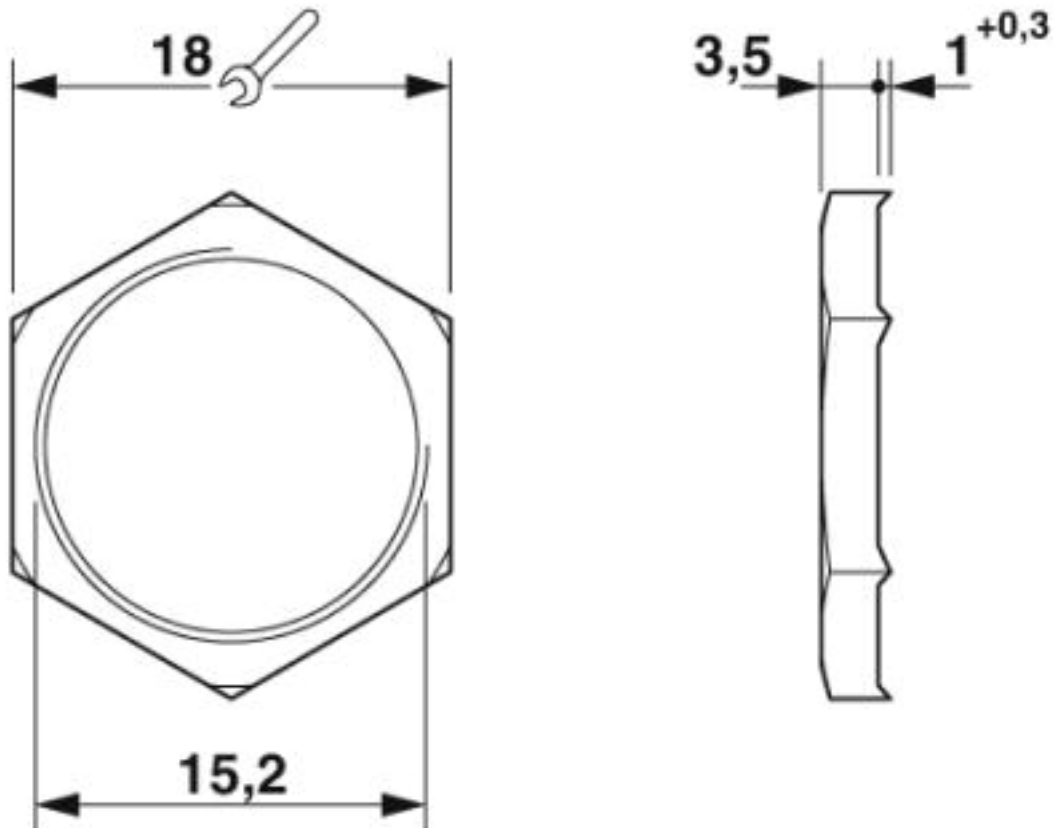

## EMV nut - A-INLE-PG9-N-S - 1411276

### Classifications

#### eCl@ss

eCl@ss 10.0.1	27144424
eCl@ss 4.0	27141200
eCl@ss 4.1	27141200
eCl@ss 5.0	27149100
eCl@ss 5.1	27149100
eCl@ss 6.0	27149100
eCl@ss 7.0	27069219
eCl@ss 8.0	27069219
eCl@ss 9.0	27144424

#### ETIM

ETIM 4.0	EC000032
ETIM 5.0	EC000129
ETIM 6.0	EC000940
ETIM 7.0	EC000940

#### UNSPSC

UNSPSC 13.2	31161716
UNSPSC 18.0	31161716
UNSPSC 19.0	31161716
UNSPSC 20.0	31161716
UNSPSC 21.0	31161716