

Counter nut - A-INL-M40-S-S - 1411252

Please be informed that the data shown in this PDF Document is generated from our Online Catalog. Please find the complete data in the user's documentation. Our General Terms of Use for Downloads are valid (<http://phoenixcontact.com/download>)

Counter nut, material: Stainless steel 1.4305, for threads M40 x 1.5, color: silver



RoHS

Key Commercial Data

Packing unit	1 pc
GTIN	 4 046356 923842
GTIN	4046356923842
Weight per Piece (excluding packing)	24.000 g
Custom tariff number	73181639
Country of origin	Germany

Technical data

Dimensions

Length	5 mm
Connecting thread diameter	40 mm
Wrench size, counter nut	46 mm
Hexagon angular dimension	50 mm

Ambient conditions

Ambient temperature (operation)	-70 °C ... 220 °C
---------------------------------	-------------------

General

Material	Stainless steel 1.4305
Thread type on connection side	M40 x 1.5
Color	silver

Counter nut - A-INL-M40-S-S - 1411252

Technical data

Standards and Regulations

Halogen-free	yes
--------------	-----

Environmental Product Compliance

China RoHS	Environmentally friendly use period: unlimited = EFUP-e
	No hazardous substances above threshold values

Drawings

Dimensional drawing

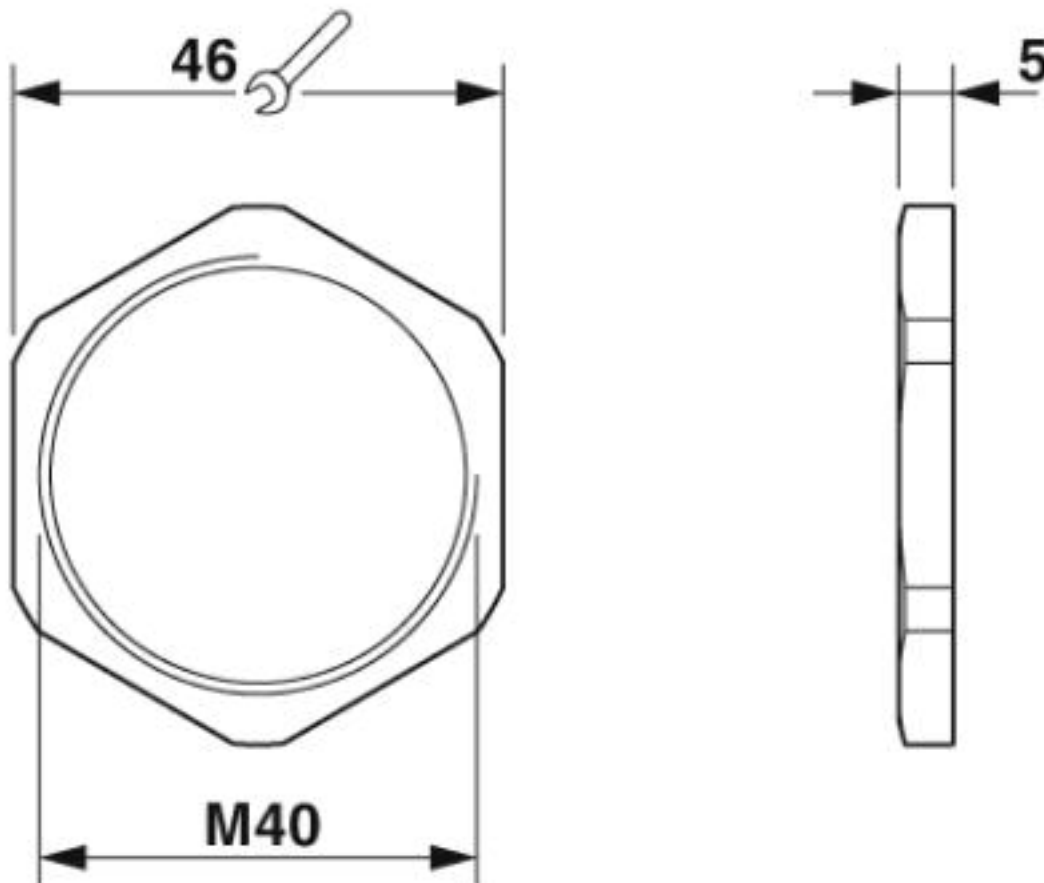

Dimensional drawing

Counter nut - A-INL-M40-S-S - 1411252

Classifications

eCl@ss

eCl@ss 10.0.1	27144424
eCl@ss 4.0	27141200
eCl@ss 4.1	27141200
eCl@ss 5.0	27149100
eCl@ss 5.1	27149100
eCl@ss 6.0	27149100
eCl@ss 7.0	27069219
eCl@ss 8.0	27069219
eCl@ss 9.0	27144424

ETIM

ETIM 4.0	EC000032
ETIM 5.0	EC000129
ETIM 6.0	EC000940
ETIM 7.0	EC000940

UNSPSC

UNSPSC 13.2	31161716
UNSPSC 18.0	31161716
UNSPSC 19.0	31161716
UNSPSC 20.0	31161716
UNSPSC 21.0	31161716