

## Sensor/actuator cable - SAC-HZ-5P-M12MS/10,0-542 SH BK - 1409582

Please be informed that the data shown in this PDF Document is generated from our Online Catalog. Please find the complete data in the user's documentation. Our General Terms of Use for Downloads are valid (<http://phoenixcontact.com/download>)



Sensor/actuator cable, 5-position, PVC, yellow, shielded, Plug straight M12, coding: A, on free cable end, cable length: 10 m



### Key Commercial Data

Packing unit	1 pc
GTIN	 4 055626 018386
GTIN	4055626018386
Weight per Piece (excluding packing)	580.000 g
Custom tariff number	85444290
Country of origin	United States

### Technical data

#### Dimensions

Length of cable	10 m
-----------------	------

#### Ambient conditions

Ambient temperature (operation)	-25 °C ... 90 °C (Plug / socket)
	-25 °C ... 90 °C (Plug / socket)
Degree of protection	IP65
	IP67

#### General

Note	These cable assemblies are UL/cUL listed for use in Class I, Division 2 (CID2) hazardous locations.
Rated current at 40°C	4 A

# Sensor/actuator cable - SAC-HZ-5P-M12MS/10,0-542 SH BK - 1409582

## Technical data

### General

Rated voltage	48 V AC
	60 V DC
Number of positions	5
Insulation resistance	≥ 100 MΩ
Coding	A - standard
Standards/regulations	M12 connector IEC 61076-2-101
Status display	No
Protective circuit/component	unwired
Overvoltage category	II
Degree of pollution	3
Torque	0.4 Nm (M12 connector)

### Material

Flammability rating according to UL 94	HB
Contact material	CuSn
Contact surface material	Ni/Au
Contact carrier material	TPU GF
Material of grip body	TPU, hardly inflammable, self-extinguishing
Material, knurls	Zinc die-cast, nickel-plated
Sealing material	NBR

### Standards and Regulations

Standards/specifications	M12 connector IEC 61076-2-101
Flammability rating according to UL 94	HB
UL, USA/Canada	Class I, Div. 2, Groups A, B, C, D

### Cable

Cable type	PVC yellow 105 °C
Cable type (abbreviation)	542
UL AWM style	2517 (105 °C / 300 V)
AWG signal line	22
Conductor structure signal line	30x 1.30 mm
Core diameter including insulation	1.27 mm ±0.03 mm
Wire colors	Brown, blue, black, white, gray
Overall twist	5 wires around filler to the core
Shielding	Tinned copper braided shield
Optical shield covering	85 %
External sheath, color	yellow
External cable diameter D	5.9 mm ±0.2 mm

# Sensor/actuator cable - SAC-HZ-5P-M12MS/10,0-542 SH BK - 1409582

## Technical data

### Cable

Minimum bending radius, flexible installation	12 x D
Cable weight	57 kg/km
Outer sheath, material	PVC
Material, filler	PP
Material conductor insulation	PVC
Conductor material	Tin-plated Cu litz wires
Insulation resistance	≥ (550 M Ohms/m @ 500V)
Conductor resistance	max. 50.5 Ω/km (20 °C)
Nominal voltage, cable	300 V
Special properties	UL standards PLTC and ITC
Other resistance	UV resistant
Flame resistance	FT4
Ambient temperature (operation)	-30 °C ... 105 °C (cable, fixed installation)
	-5 °C ... 105 °C (cable, flexible installation)

### Environmental Product Compliance

China RoHS	Environmentally Friendly Use Period = 50 years
	For details about hazardous substances go to tab "Downloads", Category "Manufacturer's declaration"

## Drawings

Schematic diagram

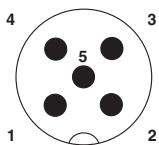

Pin assignment M12 male connector, 5-pos., A-coded, male side

Dimensional drawing

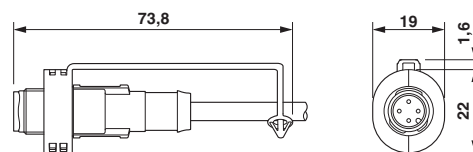

EXCLIP mounted plug

# Sensor/actuator cable - SAC-HZ-5P-M12MS/10,0-542 SH BK - 1409582

Circuit diagram

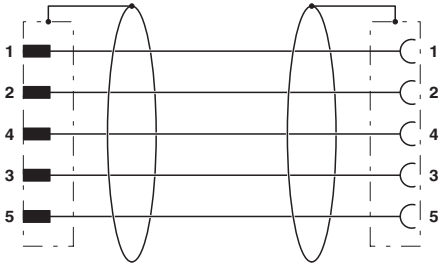

Dimensional drawing

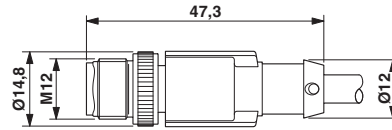

Plug, M12 x 1, straight, shielded

Contact assignment of the M12 plug and the M12 socket

Dimensional drawing

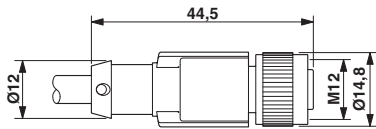

M12 x 1 socket, straight, shielded

Dimensional drawing

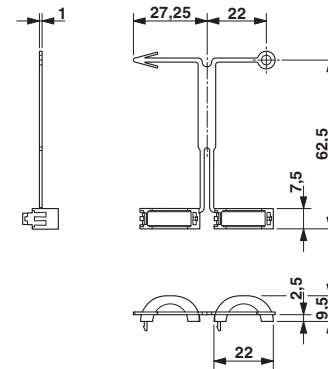

EXCLIP plug

Schematic diagram



Pin assignment M12 socket, 5-pos., A-coded, socket side view

# Sensor/actuator cable - SAC-HZ-5P-M12MS/10,0-542 SH BK - 1409582

Cable cross section

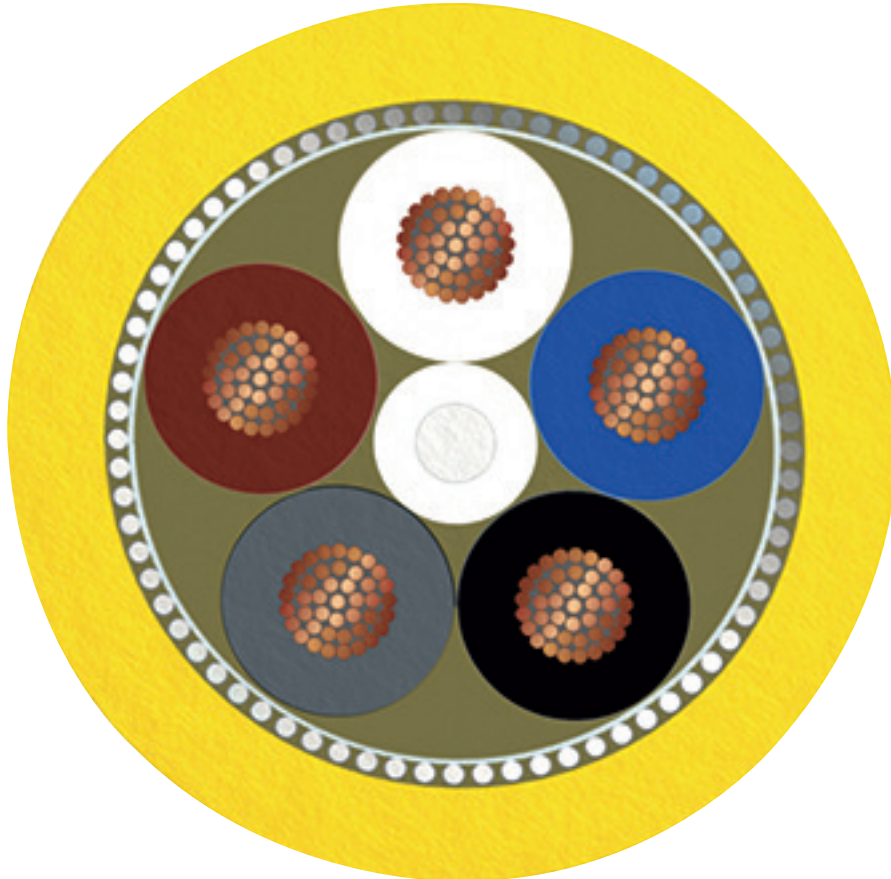

PVC yellow 105 °C [542]

## Classifications

eCl@ss

eCl@ss 10.0.1	27060311
eCl@ss 11.0	27060311
eCl@ss 4.0	27060300
eCl@ss 4.1	27060300
eCl@ss 5.0	27061800
eCl@ss 5.1	27061800
eCl@ss 6.0	27279200
eCl@ss 7.0	27279218
eCl@ss 9.0	27060311

# Sensor/actuator cable - SAC-HZ-5P-M12MS/10,0-542 SH BK - 1409582

## Classifications

### ETIM

ETIM 4.0	EC001855
ETIM 6.0	EC001855
ETIM 7.0	EC001855

### UNSPSC

UNSPSC 13.2	31251501
UNSPSC 19.0	31251501
UNSPSC 20.0	31251501
UNSPSC 21.0	31251501

## Approvals

### Approvals

Approvals

EAC-RoHS

Ex Approvals

UL Listed / cUL Listed / cULus Listed

### Approval details

EAC-RoHS		RU D- DE.HB35.B.00387
----------	--	--------------------------

## Accessories

### Accessories

Plug for cable screw gland

Screw plug - PROT-M12 MS-PA-CHAIN - 1430899

M12 sealing cap with fixing band, for sensor cables, for free M12 sockets



## Sensor/actuator cable - SAC-HZ-5P-M12MS/10,0-542 SH BK - 1409582

### Accessories

#### Protective cap

Sealing cap - PROT-M12 FS-PA-CHAIN - 1430873

M12 sealing cap made of plastic with fixing band, for sensor cables, for free M12 plugs



---

#### Safety locking

Locking clip - SAC-M12-EXCLIP-M - 1558988



Locking clip for the pin side of sensor/actuator cables with M12 connector and M12 connectors for assembly, for knurl diameter: 15 mm or for Allen key with a wrench size of 14 mm, prevents the disconnection of plug-in connections without tools

Locking clip - SAC-M12-EXCLIP-F - 1558991



Locking clip for the socket side of sensor/actuator cables with M12 connector and M12 connectors for assembly, for knurl diameter: 15 mm or for Allen key with a wrench size of 14 mm, prevents the disconnection of plug-in connections without tools

---

#### Screwdriver tools

Adapter insert - TSD-M SAC-BIT ADAPTER - 1212600



Adapter bit for TSD-M...torque tools, E6.3-1/4" drive with 4 mm hexagon to accommodate SAC bits

## Sensor/actuator cable - SAC-HZ-5P-M12MS/10,0-542 SH BK - 1409582

### Accessories

Tool - SAC BIT M12-D15 - 1208432



Nut for assembling sensor/actuator cables with M12 connector and M12 connectors for assembly, with a knurl diameter of 15 mm, for 4 mm hexagonal drive

---

### Torque tool

Torque screwdriver - TSD 04 SAC - 1208429



Torque screwdriver, with preset torque of 0.4 Nm and 4 mm hexagonal drive for M12 connectors

---

Torque screwdriver - TSD-M 1,2NM - 1212224



Torque screw driver, accuracy as per EN ISO 6789 standard, adjustable from 0.3 - 1.2 Nm

---