

## H distributor - QPD H 4PE2,5 4X6-11 BK - 1406368

Please be informed that the data shown in this PDF Document is generated from our Online Catalog. Please find the complete data in the user's documentation. Our General Terms of Use for Downloads are valid (<http://phoenixcontact.com/download>)



QUICKON H-distributor, black, 4 pos. +PE, 1.0 mm<sup>2</sup> ... 2.5 mm<sup>2</sup> / 690 V / 20 A, for cable diameters of 6 mm ... 11 mm, with a sealing bolt.

### Your advantages

- ✓ Innovative and time saving - QUICKON fast connection for time saving of up to 80 % for on-site connection
- ✓ Convenient: quick and easy assembly without special tools
- ✓ Robust throughout: housing with IP68/IP69K and IK07 protection for a wide range of applications
- ✓ Safer connection thanks to polarization against mismatching and touch-proof protection according to DIN EN 0105
- ✓ Flexible and compact - by connecting connections internally, H and T-distributors can be used to branch master cables or they can be used as star distributors

### Key Commercial Data

Packing unit	1 pc
GTIN	 4 046356 776165
GTIN	4046356776165
Weight per Piece (excluding packing)	340.000 g
Custom tariff number	85366990
Country of origin	Poland

### Technical data

#### General

Type	H-distributor
Color	black
Locking type	Screw locking
Connection method	QUICKON connection

# H distributor - QPD H 4PE2,5 4X6-11 BK - 1406368

## Technical data

### General

	IDC connection
Number of positions	5
Note number of positions	4+PE
Wrench size, union nut	27 mm
Tightening torque, union nut	10 Nm
Number of connections	5
Conductor cross section flexible min.	1 mm <sup>2</sup>
Conductor cross section flexible max.	2.5 mm <sup>2</sup>
Conductor cross section solid min.	1 mm <sup>2</sup>
Conductor cross section solid max.	2.5 mm <sup>2</sup>
Conductor cross section AWG min.	16
Conductor cross section AWG max.	14

### Cabel

Structure of individual litz in acc. with VDE 0295 / smallest wire diameter	VDE 0295 class 1 to 6/min. 0.15 mm
Wire insulation material	PVC/PE/TPE/rubber
Wire diameter including insulation	2 mm ... 3.8 mm
External cable diameter	6 mm ... 11 mm
Position marking	1, 2, 3, N, PE

### Ambient conditions

Degree of protection	IP66
	IP68 (2 m / 24 h)
	IP69K (Distance from the nozzle 150 mm)
Ambient temperature (operation)	-40 °C ... 100 °C
Ambient temperature (storage/transport)	-40 °C ... 100 °C
Temperature when conductor connected	-5 °C ... 50 °C

### Electrical characteristics

Nominal current I <sub>N</sub>	20 A
Rated current	20 A
Rated voltage (III/3)	690 V
Rated voltage (III/2)	1000 V
Rated voltage (II/2)	1000 V
Rated surge voltage (III/3)	6 kV
Rated surge voltage (III/2)	8 kV
Rated surge voltage (II/2)	8 kV

### Mechanical characteristics

## H distributor - QPD H 4PE2,5 4X6-11 BK - 1406368

### Technical data

#### Mechanical characteristics

QUICKON connectability	max. 10
Insertion/withdrawal cycles	10 (QUICKON connections max. 10)
Category of shock impact	IK07 (-25 °C)

#### Material data

Contact material	Cu
Contact surface material	silver-plated
Contact carrier material	PA
Insulating material	PA
Flammability rating according to UL 94	V0
Overvoltage category	III
Degree of pollution	3

#### Standards and Regulations

Flammability rating according to UL 94	V0
--	----

#### Environmental Product Compliance

REACH SVHC	Lead 7439-92-1
China RoHS	Environmentally Friendly Use Period = 50
	For details about hazardous substances go to tab "Downloads", Category "Manufacturer's declaration"

### Drawings

# H distributor - QPD H 4PE2,5 4X6-11 BK - 1406368

Circuit diagram

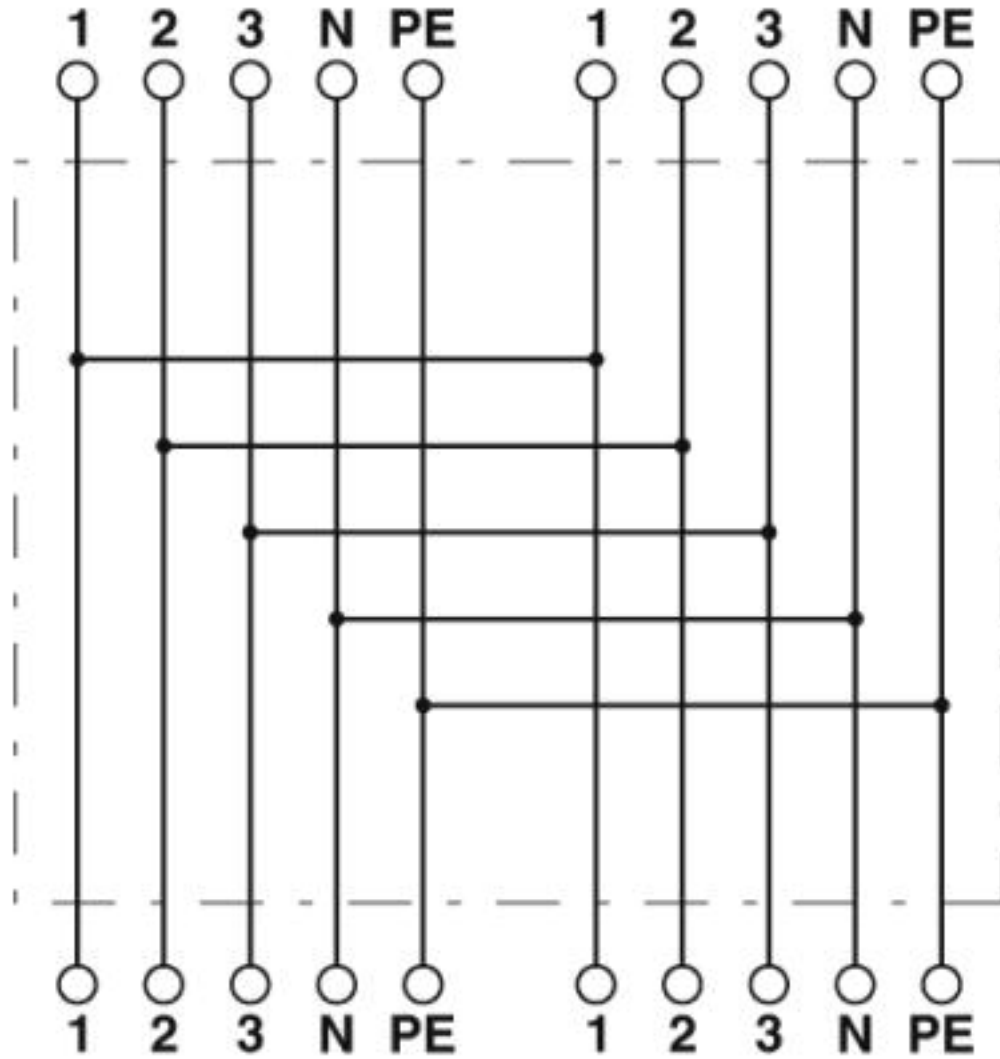

# H distributor - QPD H 4PE2,5 4X6-11 BK - 1406368

Diagram

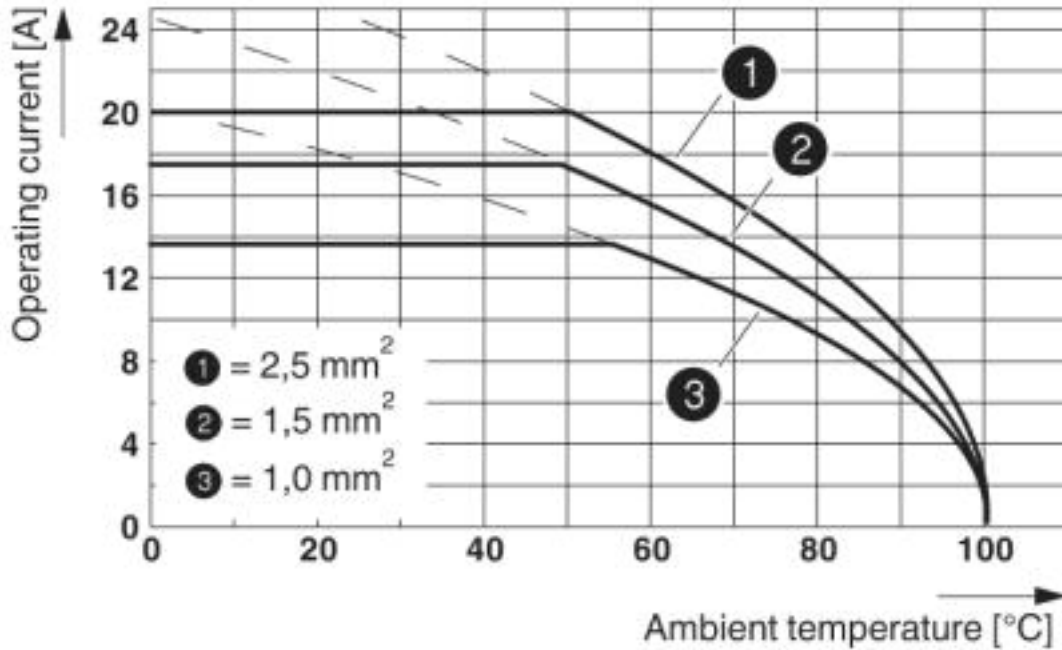

Dimensional drawing

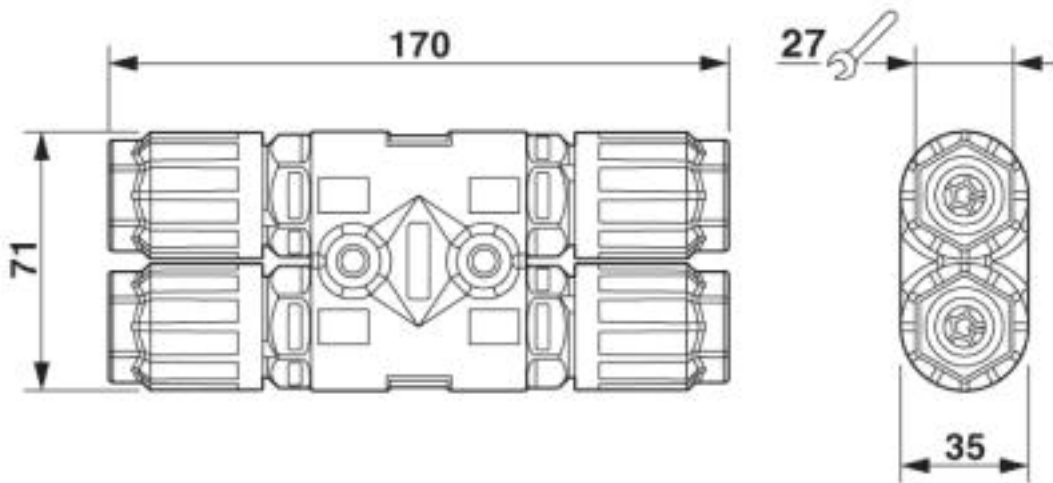

Dimensional drawing

## Classifications

eCl@ss

eCl@ss 4.0	27140800
------------	----------

## H distributor - QPD H 4PE2,5 4X6-11 BK - 1406368

### Classifications

#### eCl@ss

eCl@ss 4.1	27140800
eCl@ss 5.0	27143400
eCl@ss 5.1	27143400
eCl@ss 6.0	27143400
eCl@ss 7.0	27440603
eCl@ss 8.0	27440603
eCl@ss 9.0	27440603

#### ETIM

ETIM 3.0	EC000516
ETIM 4.0	EC000516
ETIM 5.0	EC002567
ETIM 6.0	EC002567
ETIM 7.0	EC002567

#### UNSPSC

UNSPSC 6.01	30211923
UNSPSC 7.0901	39121522
UNSPSC 11	39121522
UNSPSC 12.01	39121522
UNSPSC 13.2	31251501
UNSPSC 18.0	39121410
UNSPSC 19.0	39121410
UNSPSC 20.0	39121410
UNSPSC 21.0	39121410

### Approvals

#### Approvals

---

#### Approvals

UL Listed / IECCE CB Scheme / cUL Listed / VDE Zeichengenehmigung / EAC / DNV GL / UL Listed / cUL Listed

---

#### Ex Approvals

---

#### Approval details

# H distributor - QPD H 4PE2,5 4X6-11 BK - 1406368

## Approvals

UL Listed		<a href="http://database.ul.com/cgi-bin/XYV/template/LISEXT/1FRAME/index.htm">http://database.ul.com/cgi-bin/XYV/template/LISEXT/1FRAME/index.htm</a>	FILE E 221474
Nominal voltage UN	600 V		
Nominal current IN	10 A		
mm <sup>2</sup> /AWG/kcmil	16		

IECEE CB Scheme		<a href="http://www.iecee.org/">http://www.iecee.org/</a>	DE1-61559
-----------------	---	---	-----------

cUL Listed		<a href="http://database.ul.com/cgi-bin/XYV/template/LISEXT/1FRAME/index.htm">http://database.ul.com/cgi-bin/XYV/template/LISEXT/1FRAME/index.htm</a>	FILE E 221474
Nominal voltage UN	600 V		
Nominal current IN	10 A		
mm <sup>2</sup> /AWG/kcmil	16		

VDE Zeichengenehmigung		<a href="http://www2.vde.com/de/Institut/Online-Service/VDE-gepruefteProdukte/Seiten/Online-Suche.aspx">http://www2.vde.com/de/Institut/Online-Service/VDE-gepruefteProdukte/Seiten/Online-Suche.aspx</a>	40029149
Nominal voltage UN	690 V		
Nominal current IN	20 A		
mm <sup>2</sup> /AWG/kcmil	1-2.5		

EAC			RU C- DE.AI30.B.01102
-----	---	--	--------------------------

DNV GL		<a href="https://approvalfinder.dnvgl.com/">https://approvalfinder.dnvgl.com/</a>	TAE00003J5
--------	---	---	------------

## H distributor - QPD H 4PE2,5 4X6-11 BK - 1406368

### Approvals

UL Listed		<a href="http://database.ul.com/cgi-bin/XYVV/template/LISEXT/1FRAME/index.htm">http://database.ul.com/cgi-bin/XYVV/template/LISEXT/1FRAME/index.htm</a>	E468743
-----------	--	---	---------

cUL Listed		<a href="http://database.ul.com/cgi-bin/XYVV/template/LISEXT/1FRAME/index.htm">http://database.ul.com/cgi-bin/XYVV/template/LISEXT/1FRAME/index.htm</a>	E468743
------------	--	---	---------

### Accessories

#### Accessories

#### Coding element

Coding profile - CP-QPD 5X2,5 - 1404530



Coding profile, red, for insertion into the 5-pos. QUICKON dome and connector, can be positioned in 72° increments.

#### Device marking

Engraving material - GPE 13X 9 WH - 0806932



Engraving material, Sheet, white, unlabeled, can be labeled with: PLOTMARK, ENGRAVING UNIT, CMS-P1-PLOTTER, P1 ENGRAVING UNIT, mounting type: adhesive, lettering field size: 13 x 9 mm, Number of individual labels: 120

Plastic label - EMLP (13X9)R - 0819453



Plastic label, Roll, white, unlabeled, can be labeled with: THERMOMARK ROLLMASTER 300/600, THERMOMARK X1.2, THERMOMARK ROLL X1, THERMOMARK ROLL 2.0, THERMOMARK ROLL, mounting type: adhesive, lettering field size: 13 x 9 mm, Number of individual labels: 500

#### Protective cap

## H distributor - QPD H 4PE2,5 4X6-11 BK - 1406368

### Accessories

Protective cap - QPD QSK 5X2,5 - 1404528



Protective cap, transparent plastic, for 5x 2.5 mm<sup>2</sup> QPD QUICKON connection, IP50.

---

Protective cap - QPD QSK BK 5X2,5 FS - 1404525



Protective cap, plastic, for QUICKON connection, black, with retaining cord, IP68

---

### Sealing plugs

Closing cap - SEALING PLUG 10X16 RD - 1400284



Closing cap, material: PA, for threads pluggable, color: red

---

### Socket spanner

Socket wrench - QSS 27 - 1670646



Allen wrench, for loosening and fastening the QUICKON union nut, WAF 27 mm

---