

## Sensor/actuator cable - SAC-4P- 1,0-PUR/M12FR - 1400422

Please be informed that the data shown in this PDF Document is generated from our Online Catalog. Please find the complete data in the user's documentation. Our General Terms of Use for Downloads are valid (<http://phoenixcontact.com/download>)



Sensor/actuator cable, 4-position, PUR halogen-free, black-gray RAL 7021, free cable end, on Socket angled M12, A-coded, cable length: 1 m



### Key Commercial Data

Packing unit	1 pc
GTIN	 4 046356 496483
GTIN	4046356496483
Weight per Piece (excluding packing)	38.400 g
Custom tariff number	85444290
Country of origin	Germany

### Technical data

#### Dimensions

Length of cable	1 m
Stripping length of the free conductor end	50 mm

#### Ambient conditions

Ambient temperature (operation)	-25 °C ... 90 °C (Plug / socket)
Degree of protection	IP65
	IP67
	IP68

#### General

Rated current at 40°C	4 A
Rated voltage	250 V AC

## Sensor/actuator cable - SAC-4P- 1,0-PUR/M12FR - 1400422

### Technical data

#### General

	250 V DC
Number of positions	4
Insulation resistance	≥ 10 MΩ
Coding	A - standard
Status display	No
Overvoltage category	II
Degree of pollution	3
Insertion/withdrawal cycles	≥ 100
Torque	0.4 Nm

#### Material

Flammability rating according to UL 94	HB
Contact material	CuSn
Contact surface material	Ni/Au
Contact carrier material	TPU GF
Material of grip body	TPU, hardly inflammable, self-extinguishing
Material, knurls	Zinc die-cast, nickel-plated
Sealing material	NBR

#### Standards and Regulations

Flammability rating according to UL 94	HB
--	----

#### Cable

Cable type	PUR halogen-free black
Cable type (abbreviation)	PUR
Cable abbreviation	Li9Y11Y-HF
UL AWM style	20549 / 10493 (80°C/300 V)
Conductor cross section	4x 0.34 mm <sup>2</sup>
AWG signal line	22
Conductor structure signal line	42x 0.10 mm
Core diameter including insulation	1.27 mm ±0.02 mm
Thickness, insulation	≥ 0.21 mm
Wire colors	brown, white, blue, black
Overall twist	4 wires, twisted
External sheath, color	black-gray RAL 7021
Outer sheath thickness	approx. 0.5 mm
External cable diameter D	4.2 mm ±0.15 mm
Minimum bending radius, fixed installation	5 x D
Minimum bending radius, flexible installation	10 x D

## Sensor/actuator cable - SAC-4P- 1,0-PUR/M12FR - 1400422

### Technical data

#### Cable

Number of bending cycles	10000000
Minimum bending radius, drag chain applications	10 x D
Traversing path	10 m
Traversing rate	3 m/s
Acceleration	10 m/s <sup>2</sup>
Cable weight	30 kg/km
Outer sheath, material	PUR
Material conductor insulation	PP
Conductor material	Bare Cu litz wires
Insulation resistance	≥ 1 GΩ*km
Conductor resistance	≤ 58 Ω/km
Nominal voltage, cable	≤ 300 V
Test voltage, cable	≥ 3000 V
Special properties	Flexible cable conduit capable
	Silicone-free
	Free of substances which would hinder coating with paint or varnish
	flexible
Flame resistance	in accordance with UL 758/1581 FT2
	DIN EN 60332-2-2 (20 s)
Halogen-free	in accordance with DIN VDE 0472 part 815
	in accordance with DIN EN 50267-2-1
Resistance to oil	in accordance with DIN EN 60811-2-1
Other resistance	Highly resistant to acids, alkaline solutions and solvents
	hydrolysis and microbe resistant
	partly UV-resistant in accordance with DIN EN ISO 4892-2-A
	Low adhesion
	abrasion-resistant
Ambient temperature (operation)	-40 °C ... 80 °C (cable, fixed installation)
	-25 °C ... 80 °C (cable, flexible installation)

#### Environmental Product Compliance

China RoHS	Environmentally friendly use period: unlimited = EFUP-e
	No hazardous substances above threshold values

#### Drawings

# Sensor/actuator cable - SAC-4P- 1,0-PUR/M12FR - 1400422

Dimensional drawing

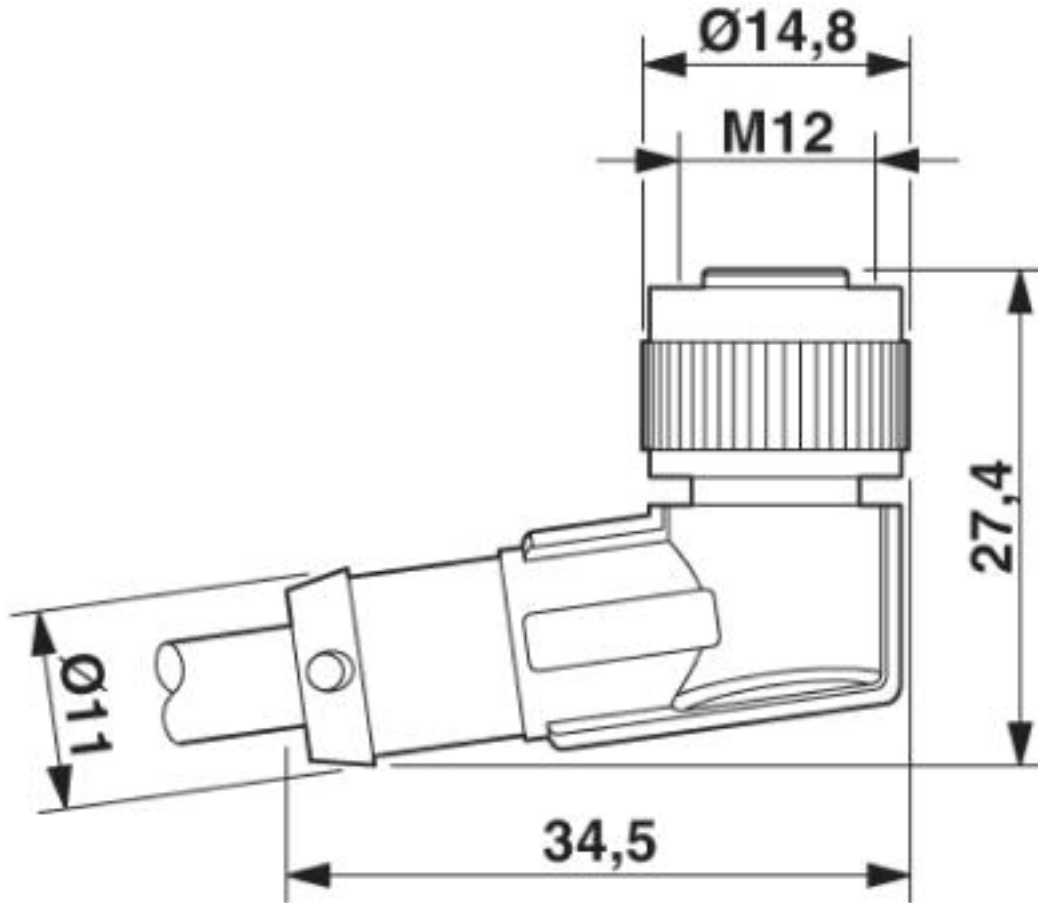

M12 x 1 socket, angled

## Sensor/actuator cable - SAC-4P- 1,0-PUR/M12FR - 1400422

Circuit diagram

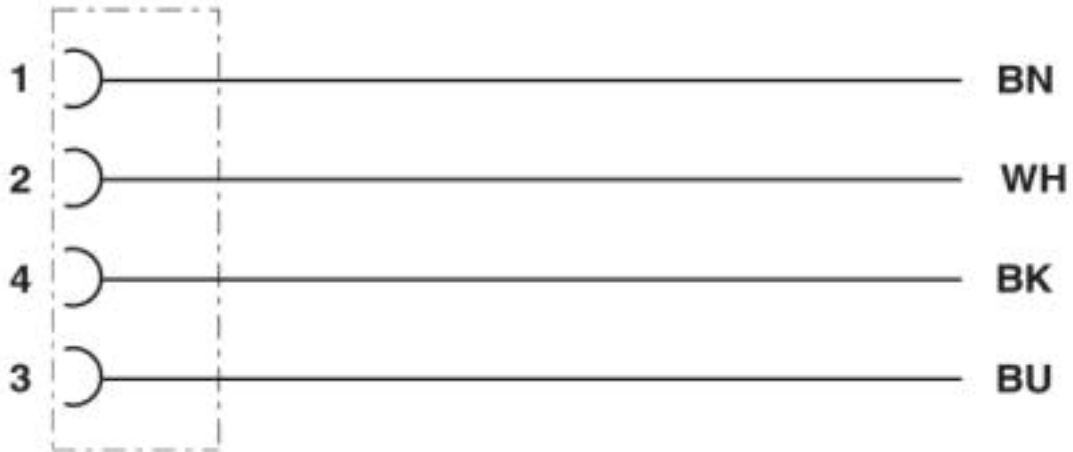

Contact assignment of the M12 socket

## Sensor/actuator cable - SAC-4P- 1,0-PUR/M12FR - 1400422

Schematic diagram

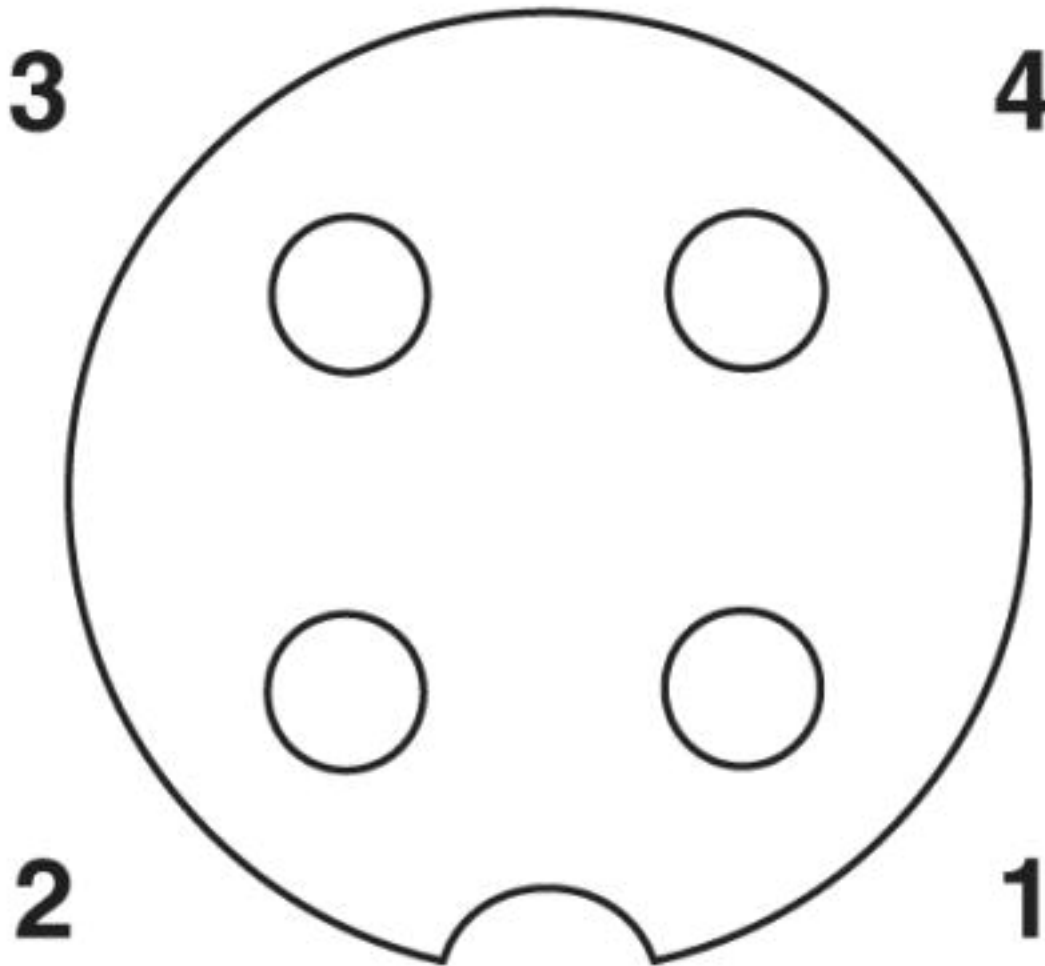

Pin assignment M12 socket, 4-pos., A-coded, view female side

## Sensor/actuator cable - SAC-4P- 1,0-PUR/M12FR - 1400422

Cable cross section

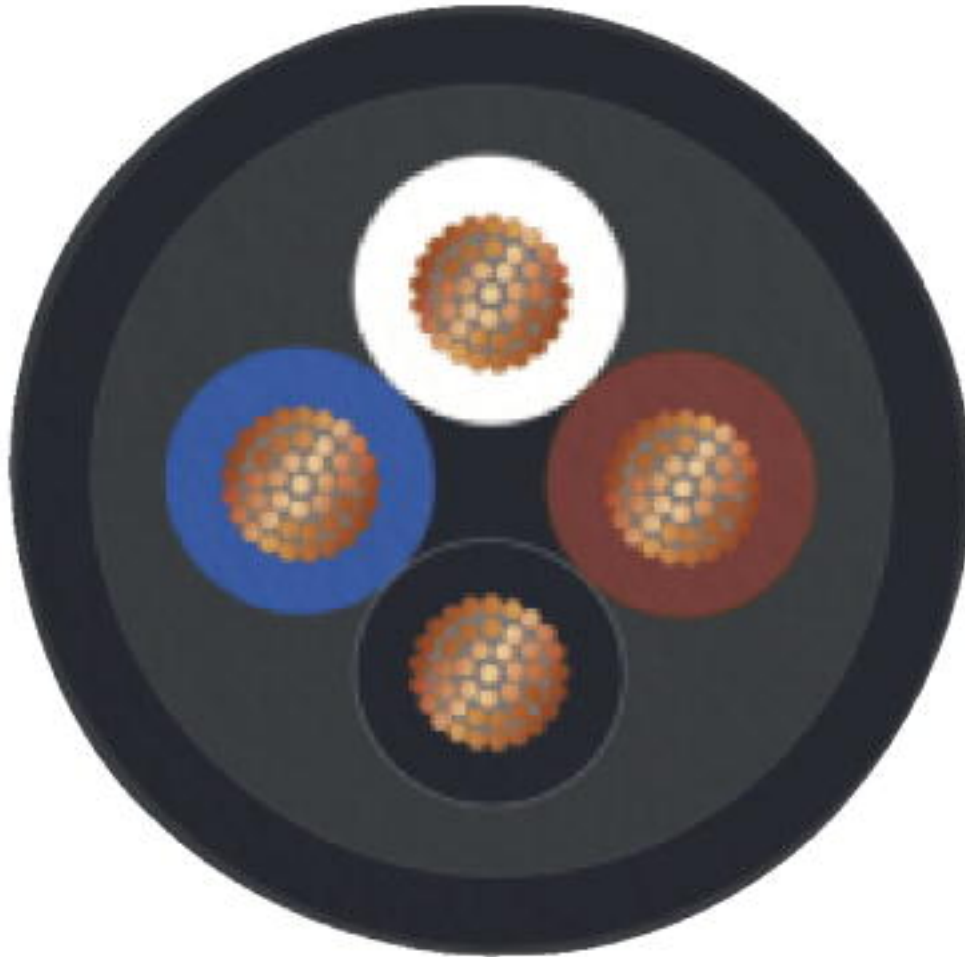

PUR halogen-free black [PUR]

### Classifications

eCl@ss

eCl@ss 4.0	27060300
eCl@ss 4.1	27060300
eCl@ss 5.0	27061800
eCl@ss 5.1	27061800
eCl@ss 6.0	27279200
eCl@ss 7.0	27279218
eCl@ss 8.0	27279218

# Sensor/actuator cable - SAC-4P- 1,0-PUR/M12FR - 1400422

## Classifications

eCl@ss

eCl@ss 9.0	27060311
------------	----------

### ETIM

ETIM 3.0	EC001855
ETIM 4.0	EC001855
ETIM 5.0	EC001855
ETIM 6.0	EC001855
ETIM 7.0	EC001855

### UNSPSC

UNSPSC 6.01	31251501
UNSPSC 7.0901	31251501
UNSPSC 11	31251501
UNSPSC 12.01	31251501
UNSPSC 13.2	31251501

## Approvals

### Approvals

Approvals

UL Listed / cUL Listed / EAC / cULus Listed

Ex Approvals

### Approval details

UL Listed		<a href="http://database.ul.com/cgi-bin/XYV/template/LISEXT/1FRAME/index.htm">http://database.ul.com/cgi-bin/XYV/template/LISEXT/1FRAME/index.htm</a>	FILE E 221474
Nominal voltage UN	300 V		
Nominal current IN	4 A		

## Sensor/actuator cable - SAC-4P- 1,0-PUR/M12FR - 1400422

### Approvals

cUL Listed		<a href="http://database.ul.com/cgi-bin/XYV/template/LISEXT/1FRAME/index.htm">http://database.ul.com/cgi-bin/XYV/template/LISEXT/1FRAME/index.htm</a>	FILE E 221474
Nominal voltage UN		300 V	
Nominal current IN		4 A	

EAC		RU C- DE.BL08.B.00286
-----	---	--------------------------

cULus Listed	
--------------	---